



# ASSEMBLY INSTRUCTIONS

Para el español, ver la página 2.  
Pour le français, voir la page 3.



## 8' x 20' OUTDOOR STORAGE SHED

Lifetime® sheds are designed to be strong and durable. We strive to make assembly as easy as possible without compromising quality. If you get stuck, we have tools to help:

- Watch Our Instructional Videos**  
 Scan the code below to see how it all comes together.
   

  
<http://go.lifetime.com/60120playlist>
- Build a Foundation**  
 Construct a level surface before you start (see page 6 for instructions).
- Recruit Friends and Family**  
 Assembly should take 3 people about 4–6 hours to complete.



### TOOLS REQUIRED



### TABLE OF CONTENTS

Icon Legend.....	4
Warnings & Notices.....	5
Platform Construction.....	6
Truss Assembly.....	11
Gable Assembly.....	17
Door Assembly.....	21
Floor Assembly.....	28
Wall Assembly.....	33
Shelving Installation.....	39
Door & Gable Installation.....	43
Parts Identifier.....	47
Roof Assembly.....	51
Window Installation.....	72
Pegboard Strip Installation.....	76
Shutter Installation.....	79
Door Alignment.....	83
Shed Anchoring.....	85
Cleaning & Care.....	91
Registration.....	92
Warranty.....	93

### NEED HELP? TALK TO US!

Lifetime's Assembly Experts offer quick responses and great customer service.

Call: 1-800-225-3865  
7:00 am–5:00 pm (Monday - Friday) MST  
and 9:00 am–1:00 pm Saturday MST

Web: [www.lifetime.com/instructions](http://www.lifetime.com/instructions)  
Live Chat: [www.lifetime.com/instructions](http://www.lifetime.com/instructions)

MODEL# AND PRODUCT ID (you will need both when contacting us)  
Model Number: Product ID:  
60120

**LIFETIME**

# INSTRUCCIONES DE ENSAMBLE

For English, see page 1.

Pour le français, voir la page 3.



## CASETA EXTERIOR DE 2,44 m x 6,10 m

Las casetas Lifetime® son diseñadas para ser sólidas y durables. Nos esforzamos por hacer el ensamble lo más fácil posible sin comprometer la calidad. Si se atasque, tenemos las herramientas necesarias para ayudarle:

- **Mire nuestros videos instructivos**

Escanee el código debajo para ver el ensamble.



<http://go.lifetime.com/60120playlist>

- **Construya una plataforma**

Construya una plataforma nivel antes de comenzar.

(vea la página 6 para las instrucciones)

- **Reuna a sus amigos y a su familia**

El ensamble debe realizarse de 3 adultos y unas 4-6 horas.



### INSTRUMENTAL REQUERIDO



### ÍNDICE

Leyenda de íconos.....	4
Advertencias y Noticias.....	5
Ensamble de la plataforma.....	6
Ensamble de las cerchas.....	11
Ensamble de las fachadas.....	17
Ensamble de las puertas.....	21
Ensamble del piso.....	28
Ensamble de los muros.....	33
Instalación de la estantería.....	39
Instalación de las puertas.....	43
Identificador de piezas.....	47
Ensamble del tejado.....	51
Instalación de las hojas de ventana.....	72
Instalación de los organizadores.....	76
Instalación de hojas de ventana.....	79
Alineación de las puertas.....	83
Anclaje de la caseta.....	85
Limpieza y Cuidado.....	91
Registro.....	92
Garantía.....	94

**¿NECESITA AYUDA? ¡LLÁMENOS!**

Los Expertos de ensamble Lifetime® ofrecen respuestas rápidas y servicio valorado.

Llame al **1.800.225.3865**  
0700-1700 lunes hasta viernes (HNR)  
y 0900-1300 sábado (HNR)

Web: [www.lifetime.com/instructions](http://www.lifetime.com/instructions)  
Live Chat: [www.lifetime.com/instructions](http://www.lifetime.com/instructions)

**MODELO E ID DEL PRODUCTO** (necesitará los dos al contactarnos)

Número de modelo: **ID del producto:**

**60120**

**LIFETIME**

# INSTRUCTIONS D'ASSEMBLAGE

For English, see page 1.

Para el español, ver la página 2.



## ABRI EXTÉRIEUR DE 2,44 m x 6,20 m

Les abris Lifetime® sont conçus pour être solides et durables. Nous nous efforçons de rendre l'assemblage aussi facile que possible sans compromettre la qualité. Si vous êtes coincé, nous avons les outils nécessaires pour vous aider :

- **Regardez nos vidéos éducatives**

Scannez le code ci-dessous pour voir l'assemblage.



<http://go.lifetime.com/60120playlist>

- **Construisez une plate-forme**

Construisez une plate-forme horizontale avant de commencer.

(voir la page 6 pour les instructions)

- **Rassemblez vos amis et votre famille**

L'assemblage devrait prendre 3 adultes à peut près 4 – 6 heures.



### OUTILS REQUIS



### SOMMAIRE

Légende des icônes.....	4
Avertissements et Notifications.....	5
Assemblage de la plate-forme.....	6
Assemblage des fermes.....	11
Assemblage des pignons.....	17
Assemblage des portes.....	21
Assemblage du plancher.....	28
Assemblage des murs.....	33
Installation de la estantería.....	39
Installation des portes.....	43
Identificateur de pièces.....	47
Assemblage du toit.....	51
Installation des carreaux.....	72
Installation des organisateurs.....	76
Installation des volets.....	79
Alignement des portes.....	83
L'ancrage de l'abri.....	85
Nettoyage et Entretien.....	91
Enregistrement.....	92
Garantie.....	95

### NÉCESSITEZ-VOUS DE L'AIDE ? PARLEZ-NOUS !

Nos experts d'assemblage Lifetime® offrent des réponses rapides et de service à la clientèle supérieure.

Composez le **1-800-225-3865**

Du lundi au vendredi 7 h – 17 h (HNR)  
et samedi 9 h – 13 h (HNR)

web: [www.lifetime.com/instructions](http://www.lifetime.com/instructions)

tchat: [www.lifetime.com/instructions](http://www.lifetime.com/instructions)

MODÈLE ET RÉFÉRENCE DU PRODUIT (vous aurez besoin des deux lorsque vous nous contactez)

Numéro de modèle : Référence du produit :

60120



## ICON LEGEND / LEYENDA DE ÍCONOS / LÉGENDE DES ICÔNES



- Indicates special heed should be taken when reading.
- Indica que uno debe prestar atención al leer.
- Ceci indique que l'on doit faire attention à ce que vous lisez.



- Indicates the parts to be used for a section.
- Indica las piezas requeridas para una sección.
- Ceci indique les pièces requises pour une section.



- Indicates no parts required for a specific section.
- Indica que ninguna pieza es requerida para una sección específica.
- Ceci indique qu'il n'y a pas de pièces requises pour une section particulière.



- Indicates the hardware to be used for a section.
- Indica el herraje requerido para una sección.
- Ceci indique la quincaillerie requise pour une section.



- Indicates no hardware required for a specific page.
- Indica que ningún herraje es requerido para una página específica.
- Ceci indique qu'il n'y a pas de quincaillerie requise pour une page particulière.



- Indicates the tools to be used for a section.
- Indica el instrumental requerido para una sección.
- Ceci indique les outils requis pour une section.



- Indicates to use/not to use an electric drill for a specific step.
- Indica usar/no usar un taladro eléctrico para un paso específico.
- Ceci indique utiliser/n'utiliser pas de perceuse électrique pour une étape particulière.



### English:

- **Failure to follow these warnings may result in serious injury or property damage and will void warranty.**
- To ensure safety, do not attempt to assemble this product without following the instructions carefully.
- Consult all local building codes to verify if the shed requires a building permit.
- Verify the foundation is completely level before assembling the shed.
- Be aware that plastic pieces can be damaged by overtightening the screws. To avoid damage, we strongly recommend the use of a drill with a low torque setting. A #2 Phillips screwdriver may also be used.
- Three capable adults are required for assembly.
- All who participate in the assembly process should wear safety glasses throughout the assembly.
- If using a ladder during assembly, use extreme caution.
- In heavy snowfall areas, we recommend removing snow from the roof.
- Do not use or store hot objects near the product.
- Proper and complete assembly are essential to reduce the risk of accident or injury.
- We strongly recommend anchoring your shed when it is finished. The last section, Shed Anchoring, in this manual shows the hardware you'll need to complete the anchoring. You can find the hardware at your local hardware store.
- **Most injuries are caused by misuse and/or not following instructions. Use caution when using this product.**

### español:

- **El incumplimiento de seguir estas advertencias puede resultar en lesiones graves o daño a la propiedad y anulará la garantía.**
- Para asegurar la seguridad, no intente ensamblar este producto sin seguir detenidamente las instrucciones.
- Consulte todos los códigos locales de construcción para averiguar si necesita un permiso de construcción.
- Verifique que la plataforma es completamente nivelada antes de ensamblar la caseta.
- Es posible endañar las piezas de plástico por apretar demasiado los tornillos. Para evitar dañar el plástico, recomendamos que use un taladro eléctrico de baja potencia. Se puede usar también un destornillador de punta Phillips n.º 2.
- Tres adultos competentes son requeridos para ensamblar la caseta.
- Todos los que participan en el ensamble de la caseta deben llevar gafas de seguridad a lo largo del ensamble.
- Si utiliza una escalera durante el ensamble, tenga cuidado extremo.
- En las áreas de nevadas fuertes, recomendamos que quite la nieve del tejado.
- No use ni almacene objetos calientes en la caseta.
- El armado propio y completo son esenciales para reducir el riesgo de accidentes y lesiones.
- Nosotros recomendamos encarecidamente que ancle la caseta al completarla. La última sección, Anclaje de la caseta, en este manual muestra el herraje que necesitará para finalizar el anclaje. Se compran estos elementos a su ferretería del barrio.
- **La mayoría de las lesiones son causadas por el uso erróneo y/o el incumplimiento de seguir las instrucciones. Tenga cuidado al usar esta caseta.**

### français :

- **La non-respect de ces avertissements peut entraîner en conséquence des blessures sérieuses ou dommage à la propriété et annulera la garantie.**
- Pour assurer votre sécurité, n'attendez pas de monter cet élément sans suivre attentivement les instructions.
- Consultez tous les codes de bâtiment locaux pour vérifier si l'abri extérieur exige d'un permis de construire.
- Vérifiez que la plate-forme est complètement nivelée avant d'assembler l'abri.
- Il est possible endommager les pièces en plastique par serrer les vis excessivement. Pour éviter endommager le plastique, nous recommandons vivement l'usage d'une perceuse électrique de faible puissance. Vous pouvez aussi utiliser un tournevis cruciforme N° 2.
- Trois adultes capables sont requis pour monter cet élément.
- Tous les personnes qui participent dans l'assemblage doivent porter des lunettes de sécurité tout le long de l'assemblage.
- Si vous utilisez une échelle pendant le montage, utilisez-la avec prudence.
- Dans les régions de grosses chutes de neige, nous recommandons que vous enleviez la neige du toit.
- N'utilisez pas ni conservez pas les objets chauds dans l'abri.
- Le montage propre et complète sont essentiels pour réduire le risque des hasards ou des blessures.
- Nous recommandons vivement que vous anciez votre abri après avoir le complété. La dernière section, Ancrage de l'abri, dans ce manuel montre les accessoires requis pour compléter l'ancrage. Vous pouvez acheter ces accessoires à votre quincaillerie de coin.
- **La plupart des blessures sont causées par l'abus et/ou par ne pas suivre les instructions. Faites attention lorsque vous utilisiez cet abri.**

# 1

## PLATFORM CONSTRUCTION / CONSTRUCCIÓN DE LA PLATAFORMA / CONSTRUCTION DE LA PLATE-FORME



• You must provide a platform on which to assemble your shed. Proper building permit documentation may be required in your neighborhood. Consult all local building codes prior to assembling the shed. Before beginning assembly, you must pour or construct a platform. There are two types:

- Concrete
- Wood Frame

Select the type, but know the surface must be leveled and flat before installation. If the surface is not properly leveled and flat, the shed will not assemble correctly. Proper surface leveling will save you time in the long run, so please do not ignore this step.

**We recommend a Concrete platform. It will be the most durable and long-lasting choice. The platform you choose must be built above ground in order to avoid water pooling inside the shed. All lumber must be rated for outdoor use!**



• Es preciso construir una plataforma sobre la cual usted debe ensamblar su caseta. Puede suceder que en su vecindario se requiera la documentación apropiada de un permiso de construcción. Consulte todos los códigos locales de construcción y los reglamentos de la ciudad y el municipio para asegurarse de que la construcción de la caseta no requiere un permiso de construcción. Antes de comenzar el ensamble, es necesario verter o construir una plataforma. Hay dos clases:

- Concreto
- Armazón de madera

Seleccione la clase, mas sepa que la superficie debe estar nivelada y plana antes de comenzar el ensamble. Si la superficie no está nivelada y plana de manera adecuada, la caseta no podrá armarse correctamente. La nivelación de la superficie le ahorrará tiempo de trabajo, por lo tanto, le pedimos que no ignore este paso. **Recomendamos una plataforma hecho de concreto. Será la elección más perdurable. La plataforma debe ser construida arriba del suelo para evitar el aflujo de agua dentro de la caseta. ¡Toda la madera debe estar clasificada para el uso externo!**



• Il faut construire une plate-forme sur laquelle vous devez assembler votre abri. Il est possible que votre quartier exige une documentation visant les permis de construire. Consultez tous les codes du bâtiment locaux, ainsi que les décrets des villes et comtés, pour vérifier que la construction de l'abri extérieur n'exige pas un permis de construire. Avant de commencer l'assemblage, il faut couler ou construire une plate-forme. Il y a deux styles :

- Béton
- Cadre à bois

Sélectionnez le style, mais sachez que la surface d'installation doit être de niveau et plate. Si la surface n'est pas correctement de niveau et plate, l'assemblage de l'abri ne se fera pas correctement. Vous gagnerez du temps sur le long terme grâce à une surface bien de niveau, ne négligez donc pas cette étape. **Nous recommandons une plate-forme en Béton. Ce choix sera le plus durable. La plate-forme que vous choisissez doit être construite au-dessus du sol afin d'éviter l'accumulation d'eau à l'intérieur de l'abri. Tous le bois d'oeuvre doit être approuvé pour l'usage à l'extérieur !**

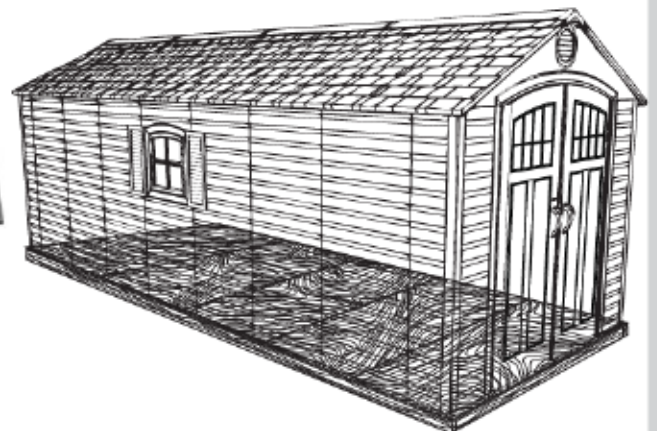
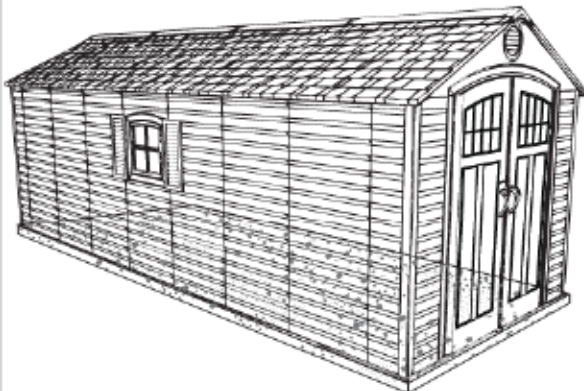

## ► SECTION 1 (CONTINUED) / SECCIÓN 1 (CONTINUACIÓN) / SECTION 1 (SUITE)

CONCRETE REQUIRED / CONCRETO REQUERIDO / BÉTON REQUIS



2 yd<sup>3</sup> (1,53 m<sup>3</sup>)

# 1.1

### CONCRETE PLATFORM / PLATAFORMA DE CONCRETO / PLATE-FORME EN BÉTON

- The concrete should be approximately 4" (10,2 cm) thick. The actual dimensions of the shed, at its widest and longest points, are 96" x 240" (2,44 m x 6,10 m). Ensure you select a site that will accommodate these measurements. **The floor dimensions are a bit smaller than those of the roof; therefore, you will need to build a level surface of 93 1/2" x 237" (2,38 m 6,02 m).**
- El concreto debe tener, por lo menos, 10,2 cm (4") de espesor. Las dimensiones reales de la caseta, a sus puntos más ancho y largo, son 2,44 m x 6,10 m (96" x 240"). Asegúrese de seleccionar un sitio que acomodará estas medidas. **Las dimensiones del piso de la caseta son más pequeñas que el tejado; entonces, necesitará crear una superficie nivel de 2,38 m 6,02 m (93 1/2" x 237").**
- Le béton doit être un épaisseur de 10,2 cm (4"). Les dimensions réelles de votre abri, aux points les plus large et long, sont 2,44 m x 6,10 m (96" x 240"). Assurez-vous de sélectionner un site qui accommodera ces dimensions. **Les dimensions du plancher de votre abri sont plus petites que le toit; ensuite, il faut créer une surface horizontale de 2,38 m x 6,02 m (93 1/2" x 237").**

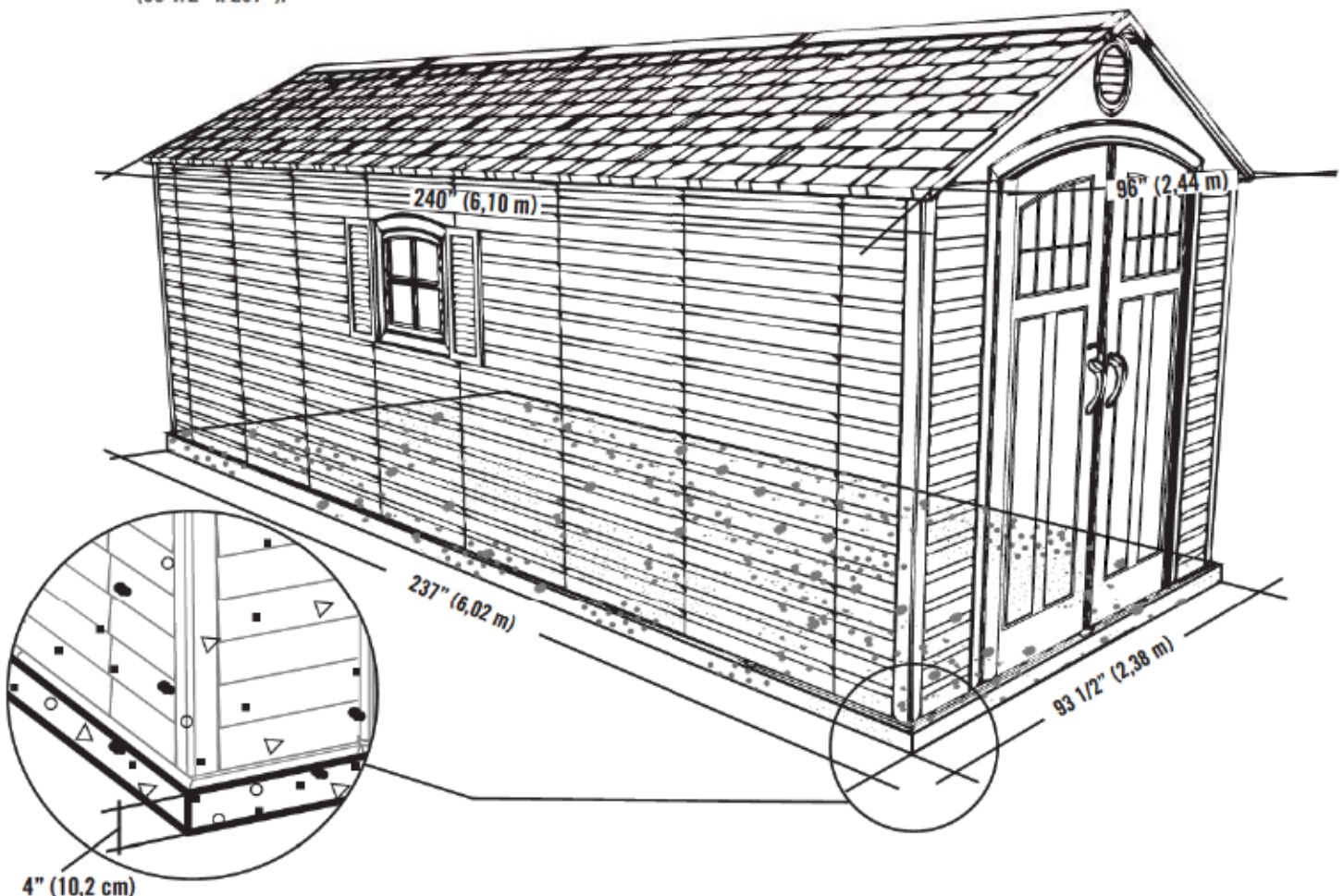

4" (10,2 cm)

► SECTION 1 (CONTINUED) / SECCIÓN 1 (CONTINUACIÓN) / SECTION 1 (SUITE)

WOOD REQUIRED / MADERA REQUERIDA / BOIS REQUIS



1.2

WOOD PLATFORM / PLATAFORMA DE MADERA / PLATE-FORME EN BOIS

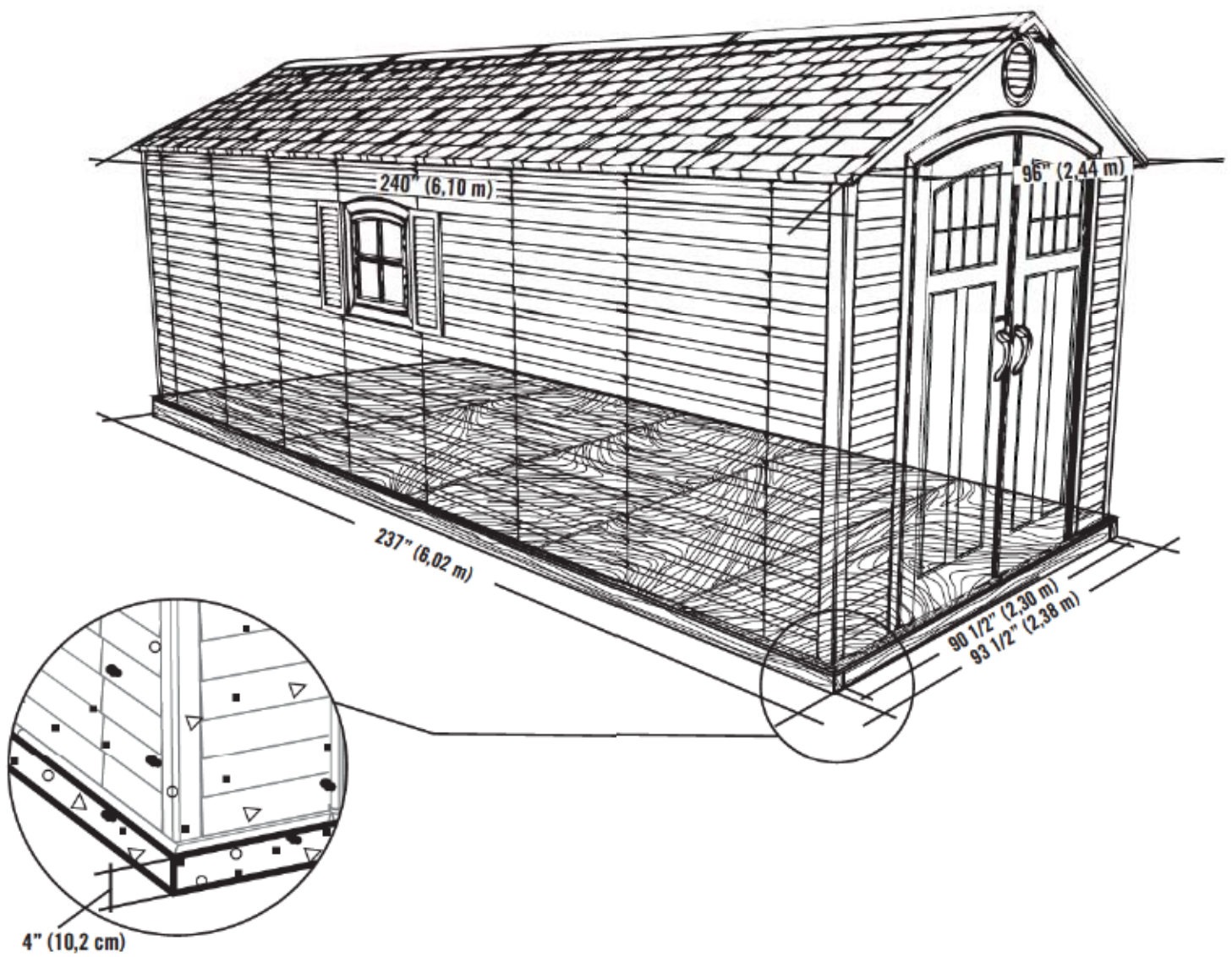



## ► SECTION 1 (CONTINUED) / SECCIÓN 1 (CONTINUACIÓN) / SECTION 1 (SUITE)

TOOLS, PARTS, AND HARDWARE REQUIRED / INSTRUMENTAL, PIEZAS, Y HERRAJE REQUERIDOS / OUTILS, PIÈCES, ET QUINCAILLERIE REQUIS



2" x 4" x 237" (5,1 cm x 10,2 cm x 6,02 m) (x2)



2" x 4" x 90 1/2" (5,1 cm x 10,2 cm x 2,30 m) (x16)

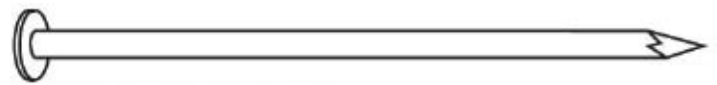

16d 3 1/2" (16d x 8,89 cm) (x64)

### 1.2.1

#### WOOD PLATFORM / PLATAFORMA DE MADERA / PLATE-FORME EN BOIS

- Ensure all lumber is treated and approved for outdoor use. Build frame to 93 1/2" x 237" (2,38 m x 6,02 m) (**outside dimensions**).
- Asegure que use madera tratada y aprobada para el uso externo. Construya el armazón a 2,38 m x 6,02 m (93 1/2" x 237") (**dimensiones exteriores**).
- Vérifiez que votre bois d'œuvre à été traité et approuvé pour l'utilisation à l'extérieur. Construisez un cadre de 2,38 m x 6,02 m (93 1/2" x 237") (**dimensions extérieures**).

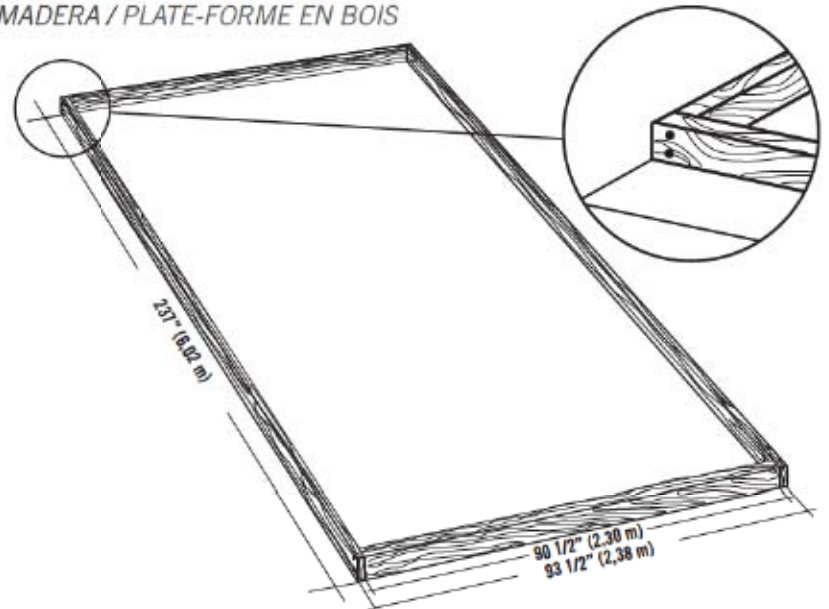

### 1.2.2

- To ensure studs are in the correct location for nailing plywood in the next step, start measuring from the corner 16" (40,1 cm), and then measure from center to center.
- Para asegurarse que los montantes están en las ubicaciones correctas para el contrachapado en el paso siguiente, comience a medir desde el borde del montante hasta el centro del próximo montante 40,1 cm (16"). Luego, tome la medida de centro a centro en los montantes restantes.
- Pour être sûr d'avoir assez de montant pour clouer le contreplaqué dans la prochaine étape, commencez à mesurer à partir de cette montant 40,1 cm (16") vers le centre du deuxième montant. Ensuite, mesurez de centre à centre pour les montants restants.

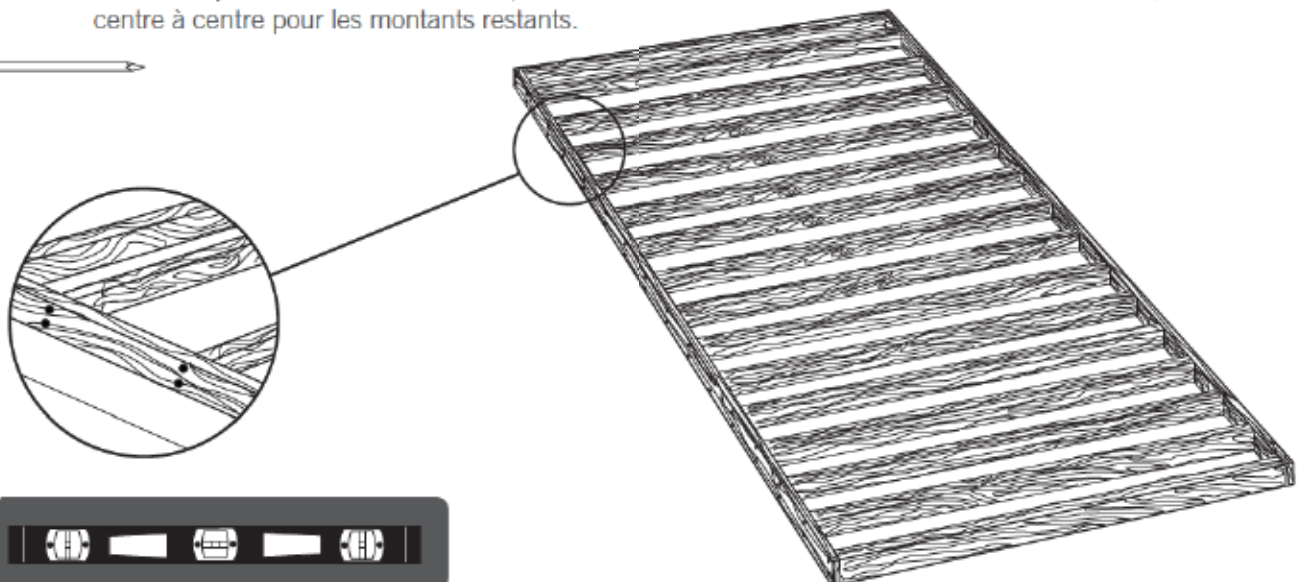

## ▶ SECTION 1 (CONTINUED) / SECCIÓN 1 (CONTINUACIÓN) / SECTION 1 (SUITE)

TOOLS, PARTS, AND HARDWARE REQUIRED / INSTRUMENTAL, PIEZAS, Y HERRAJE REQUERIDOS / OUTILS, PIÈCES, ET QUINCAILLERIE REQUIS

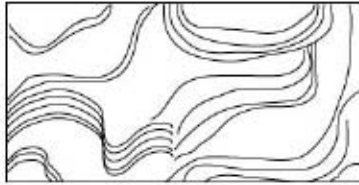

48" x 93 1/2" x 3/4"  
(1,22 m x 2,38 m x 19,1 mm) (x4)



45" x 93 1/2" x 3/4"  
(114 cm x 2,38 m x 19,1 mm) (x1)

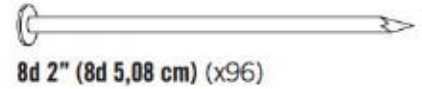

8d 2" (8d 5,08 cm) (x96)

### 1.2.3

- Square the frame, measuring from corner to corner. **Measurement A & B should be about the same length.**
- Cuadre el armazón midiendo de esquina a esquina. **La medida «A» y «B» deben ser aproximadamente el mismo largo.**
- Carrez le cadre en mesurant d'angle à angle. **La mesure « A » et « B » doivent être à peu près la même longueur.**

! A = B

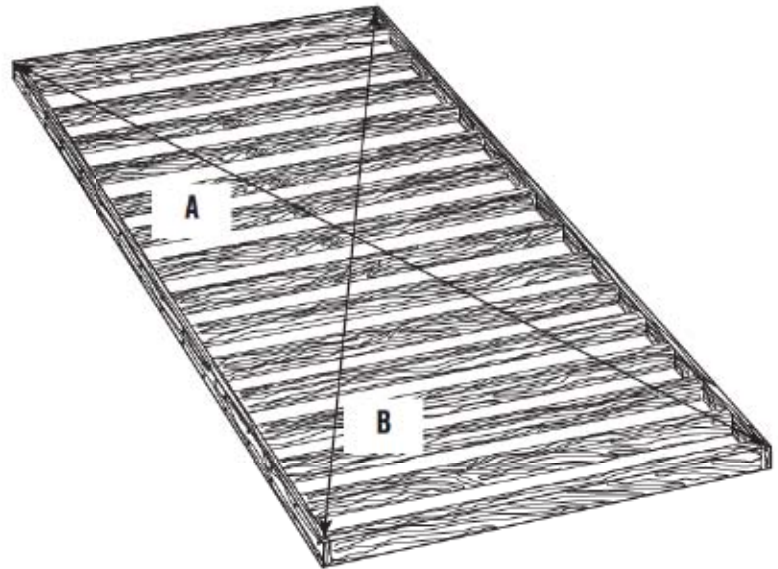

### 1.2.4

- Using nails, fasten the plywood to the frame. Then, drill 5/16" (8 mm) holes for drainage.
- Usando unos clavos, sujete el contrachapado al armazón. Entonces, taladre agujeros de 8 mm para el drenaje.
- En utilisant des clous, attachez bien le contreplaqué au cadre. Ensuite, percez des trous de 8 mm pour le drainage.

45" x 93 1/2" x 3/4"  
(114 cm x 2,38 m x 19,1 mm)



x96

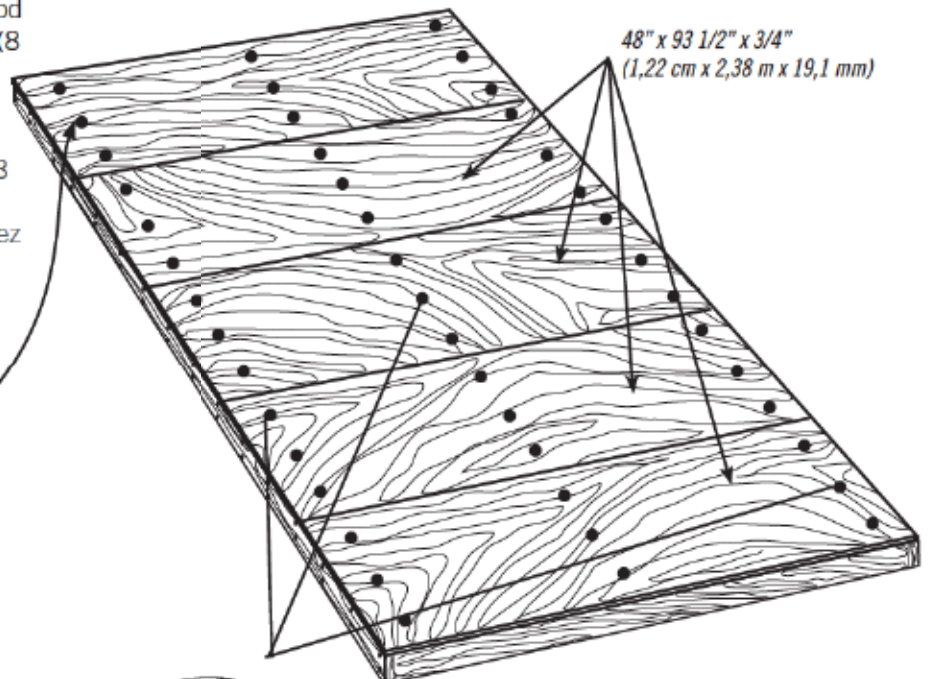

48" x 93 1/2" x 3/4"  
(1,22 cm x 2,38 m x 19,1 mm)



Drainage Holes  
Agujeros para canalización  
Trous de drainage

**x45!**

# 2

## TRUSS ASSEMBLY / ENSAMBLE DE LAS CERCHAS / ASSEMBLAGE DES FERMES



### HARDWARE REQUIRED / HERRAJE REQUERIDO / QUINCAILLERIE REQUISE

Hardware Bag / Bolsa de herraje / Sac de quincaillerie



DTK (x28)



ADK (x56)



ADJ (14)

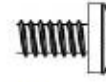

ADY (x28)

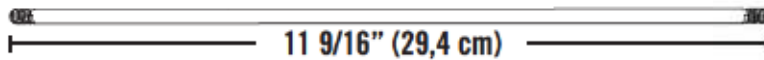

ADH (x7)



### PARTS REQUIRED / PIEZAS REQUERIDAS / PIÈCES REQUISES

Metal Parts / Piezas de metal / Pièces en métal



DSR (x14)

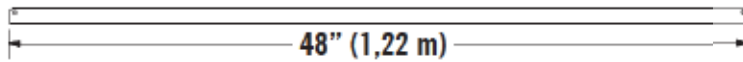

AFG (x7)



BQW (x28)

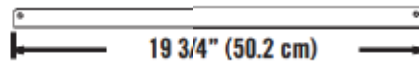

BRD (x7)



AIP (x7)



BRK (x56)



### TOOLS REQUIRED / INSTRUMENTAL REQUERIDO / OUTILS REQUIS



7/16" (11 mm) (x2)



3/8" (10 mm)



3/8" (10 mm)

## ► SECTION 2 (CONTINUED) / SECCIÓN 2 (CONTINUACIÓN) / SECTION 2 (SUITE)

TOOLS AND HARDWARE REQUIRED / INSTRUMENTAL Y HERRAJE REQUERIDO / OUTILS ET QUINCAILLERIE REQUIS



3/8"  
(10 mm)



DTK (x28)



ADK (x28)



- If you have trouble with this section, follow the code below to view a video on how to assemble these Trusses.
- Si tiene problemas con esta sección, siga el código debajo para ver un video sobre el ensamble de estas Cerchas.
- Si vous avez des problèmes avec cette section, suivez le code en bas pour voir un vidéo sur l'assemblage de ces Fermes.



<http://go.lifetime.com/trussnowload>

### 2.2

- Attach the **Connector** using the hardware indicated. **Do not overtighten the Cap Nuts.**
- Sujete el **Connector (AIP)** usando el herraje indicado. **No apriete demasiado las Tuercas ciegas.**
- Attachez le **Raccord (AIP)** à l'aide de la quincaillerie incluse. **Ne pas serrer excessivement les Écrous à chape.**

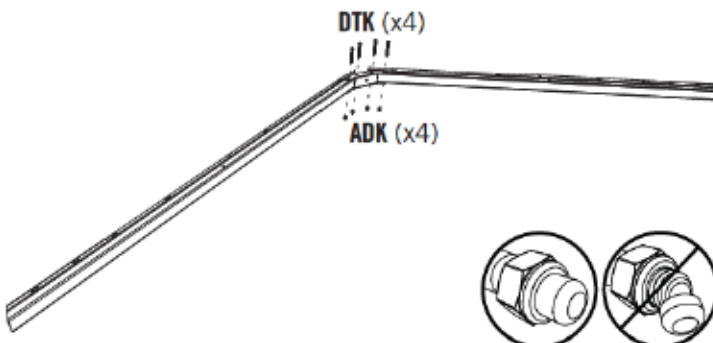

### 2.1

- Slide a **Connector (AIP)** onto the ends of two **Truss Gutter Channels (DSR)** as shown.
- Deslice un **Connector (AIP)** en los extremos de los **Canalones de la cercha (DRS)** como se muestra.
- Glissez un **Raccord (AIP)** sur les extrémités des **Canaux de gouttière (DSR)** comme illustré.

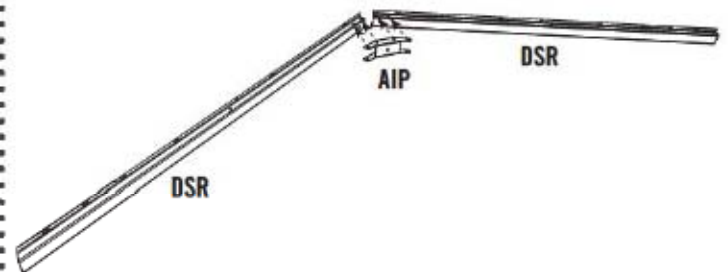

### 2.3

- Slide a **Large Truss Brace (AFG)** onto the Truss Gutter Channels as shown, and align the holes.
- Deslice un **Soporte grande de la cercha (AFG)** sobre los Canalones de la cercha como se muestra, y alinee los agujeros.
- Glissez un **Support grand de la ferme (AFG)** sur les Canaux de gouttière comme illustré, et alignez les trous.

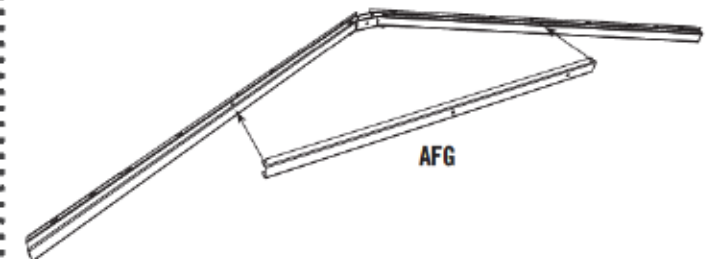

## ► SECTION 2 (CONTINUED) / SECCIÓN 2 (CONTINUACIÓN) / SECTION 2 (SUITE)

TOOLS AND HARDWARE REQUIRED / INSTRUMENTAL Y HERRAJE REQUERIDO / OUTILS ET QUINCAILLERIE REQUIS



3/8"  
(10 mm)

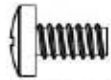

ADY (x28)



ADK (x28)

### 2.4

- Attach the Large Truss Brace using the hardware provided. **Do not overtighten the Cap Nuts.**
- Sujete el Soporte grande de la cercha usando el herraje incluido. **No apriete demasiado las Tuercas ciegas.**
- Attachez le Support grand de la ferme à l'aide de la quincaillerie incluse. **Ne pas serrer excessivement les Écrous à chape.**

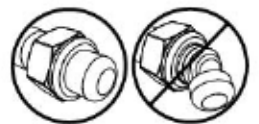
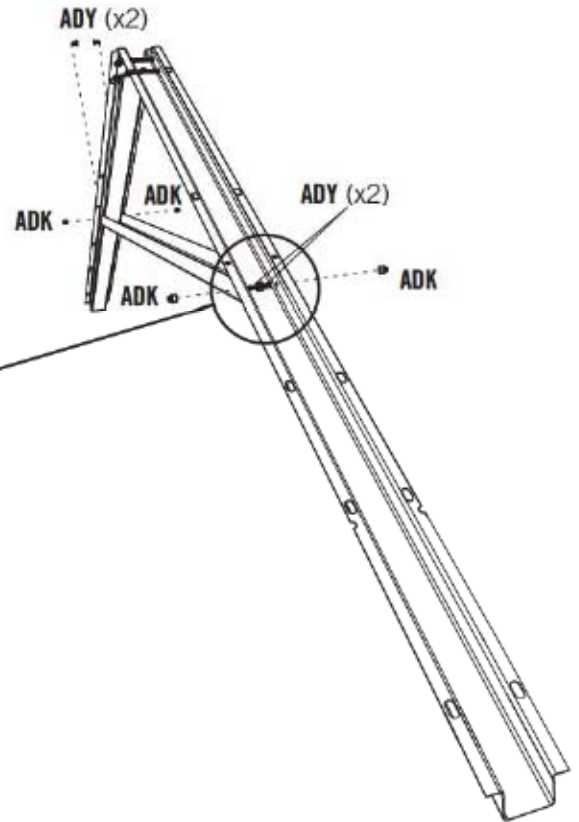
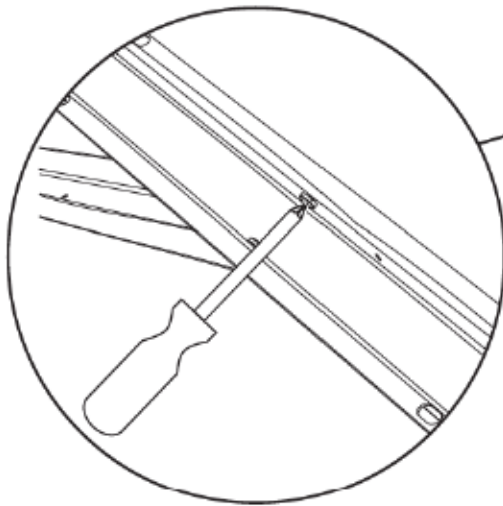

## ► SECTION 2 (CONTINUED) / SECCIÓN 2 (CONTINUACIÓN) / SECTION 2 (SUITE)

TOOLS AND HARDWARE REQUIRED / INSTRUMENTAL Y HERRAJE REQUERIDO / OUTILS ET QUINCAILLERIE REQUIS



7/16" (x2)  
(11 mm) (x2)



ADJ (x14)

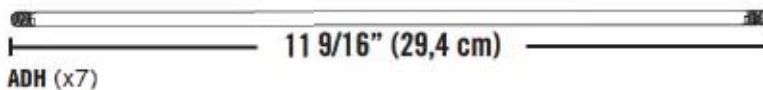

### 2.5

- Slide a **Truss Rod (ADH)** through the holes in the Large Truss Brace, **Small Truss Brace (BRD)**, and Connector. Secure with two **Cap Nuts (ADJ)**.
- Deslice una **Varilla (ADH)** a través de los agujeros en el Soporte grande, el **Soporte pequeño (BRD)**, y el Conector. Sujétela con dos **Tuercas ciegas (ADJ)**.
- Glissez une **Tige (ADH)** à travers les trous dans le Grand Support, le **Petit Support (BRD)**, et le Raccord. Attachez-la bien à l'aide de deux **Écrous à chape (ADJ)**.

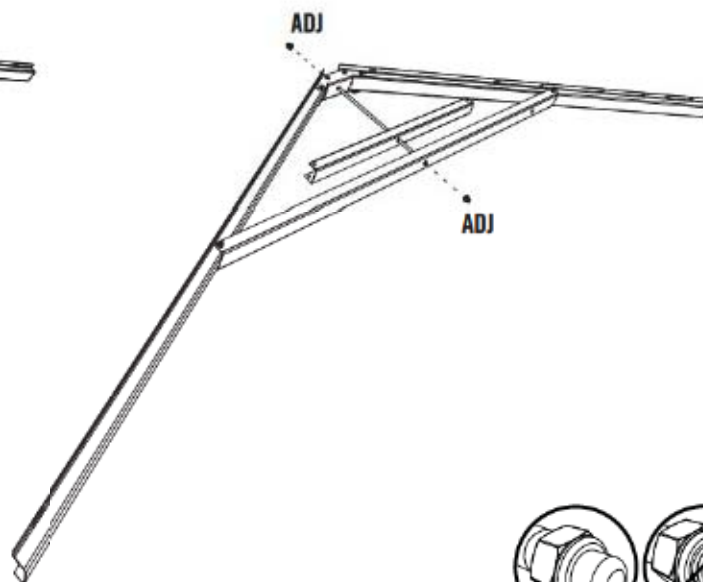
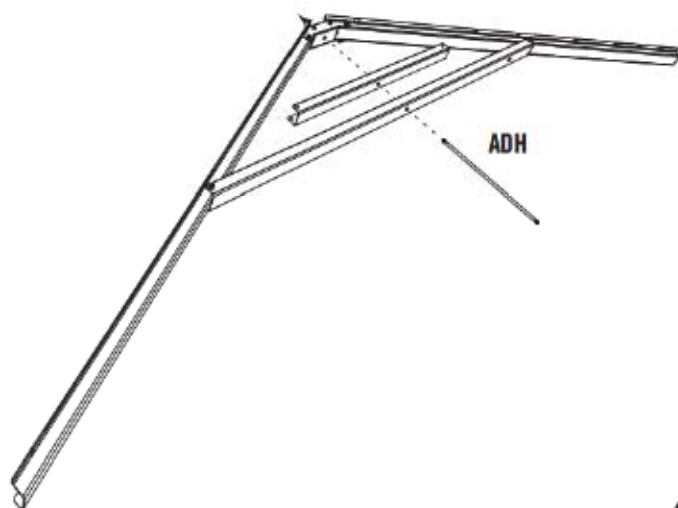

### 2.6

- Repeat this section six times.
- Repita esta sección seis veces.
- Répétez cette section six fois.

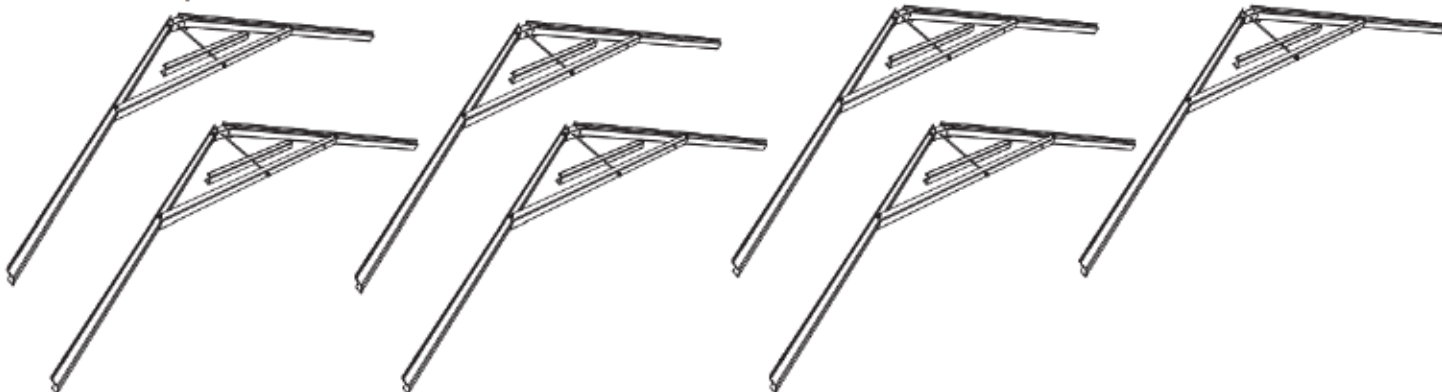

## ► SECTION 2 (CONTINUED) / SECCIÓN 2 (CONTINUACIÓN) / SECTION 2 (SUITE)

TOOLS AND HARDWARE REQUIRED / INSTRUMENTAL Y HERRAJE REQUERIDO / OUTILS ET QUINCAILLERIE REQUIS



### 2.7

- Align the **Gusset (BQW)** with the Truss Assembly as shown. Insert only two (2) **Screws (BRK)** through the Gusset and Large Truss Brace at the locations shown. **You must use a drill and 3/8" (10 mm) nut driver for this step.**
- Alinee la **Placa de refuerzo (BQW)** con el Conjunto de la cercha como se muestra. Inserte sólo dos (2) **Tornillos (BRK)** a través de la Placa de refuerzo y el Soporte grande de la cercha a las ubicaciones indicadas. **Es preciso usar un taladro eléctrico y una llave de tuerca de 3/8" (10 mm) en este paso.**
- Alignez le **Gousset (BQW)** avec le Montage de la ferme comme illustré. Insérez seulement deux (2) **Vis (BRK)** à travers le Gousset et le Grand Support aux emplacements indiqués. **Il faut utiliser une perceuse électrique et un tournevis à écrou de 10 mm dans cette étape.**

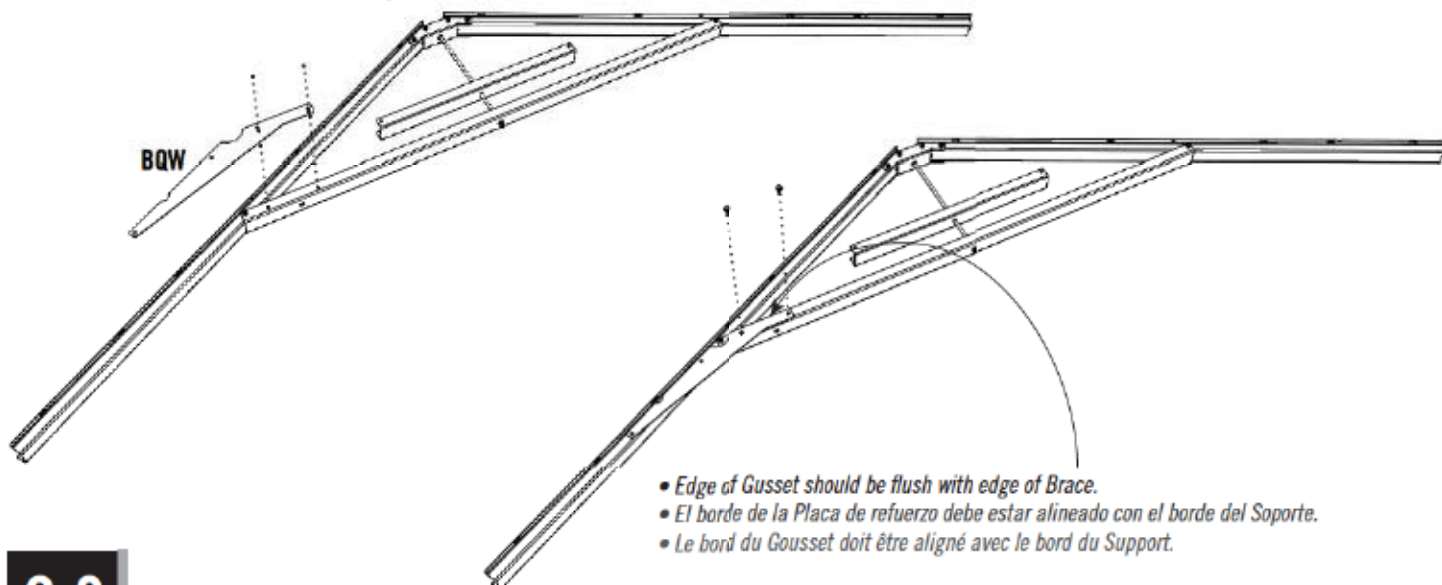

### 2.8

- Repeat the last step for all four Gussets (BQW).
- Repita el paso anterior para todos los cuatro Gussets (BQW).
- Répétez l'étape précédente pour les quatre Gussets (BQW).

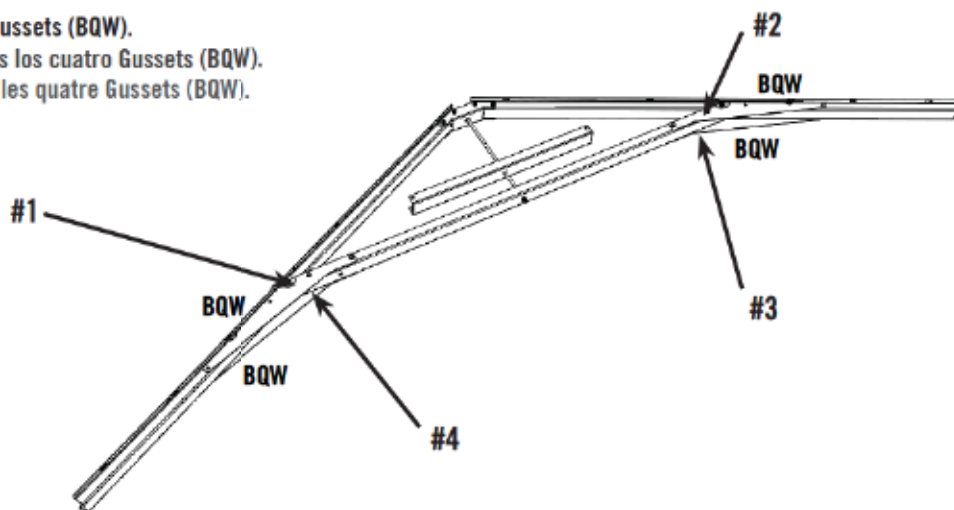

## ► SECTION 2 (CONTINUED) / SECCIÓN 2 (CONTINUACIÓN) / SECTION 2 (SUITE)

TOOLS AND HARDWARE REQUIRED / INSTRUMENTAL Y HERRAJE REQUERIDO / OUTILS ET QUINCAILLERIE REQUIS



3/8"  
(10 mm)

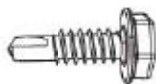

BRK (x48)

### 2.9

- Repeat steps 2.7–2.8 for the remaining six Truss Assemblies (seven in all). You must use a drill and 3/8" (10 mm) nut driver for this step. The remaining Screws (BRK) will be used in Section 10: Roof Assembly.
- Repita los pasos 2.7–2.8 para los seis Cerchas restantes (siete en total). Es preciso usar un taladro eléctrico y una llave de tuerca de 3/8" (10 mm) en este paso. Se usarán los Tornillos (BRK) restantes en la Sección 10: Ensamble del tejado.
- Répétez les étapes 2.7 – 2.8 pour les six Montages de la ferme restants (sept au total). Il faut utiliser une perceuse électrique et un tournevis à écrou de 10 mm dans cette étape. Vous utiliserez les Vis (BRK) restantes dans la Section 10 : Assemblage du toit.

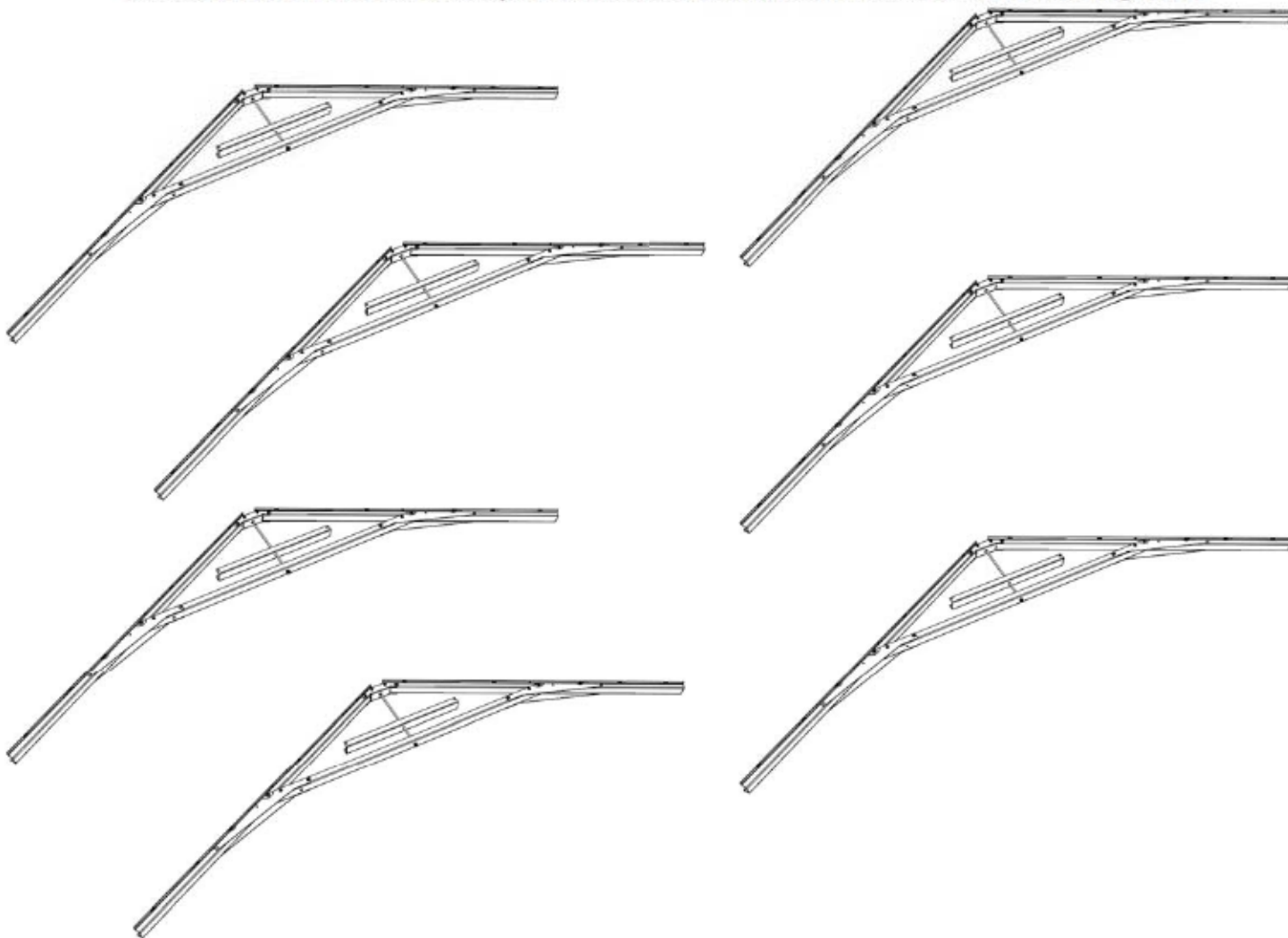



# 3

## GABLE ASSEMBLY / ENSAMBLE DE LAS FACHADAS / ASSEMBLAGE DES PIGNONS



### HARDWARE REQUIRED / HERRAJE REQUERIDO / QUINCAILLERIE REQUISE

Hardware Bag / Bolsa de herraje / Sac de quincaillerie



ADW (x10)

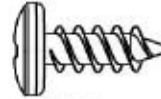

ADZ (x8)



ADV (x12)



AHS (x4)



ACB (x2)



AEE (x10)



AGP (x2)

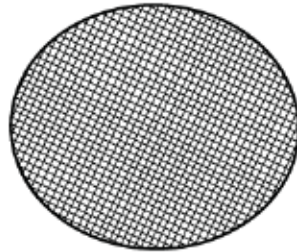

AIQ (x2)



### PARTS REQUIRED / PIEZAS REQUERIDAS / PIÈCES REQUISES

Metal Part / Pieza de metal / Pièce en métal

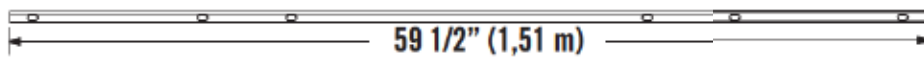

AFE (x1)



Plastic Parts / Piezas de plástico / Pièces en plastique



AGF (x1)

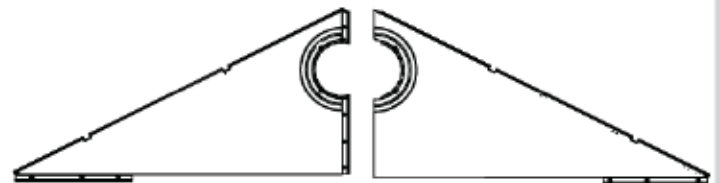

AGI (x1)

AGH (x1)



### TOOLS REQUIRED / INSTRUMENTAL REQUERIDO / OUTILS REQUIS



## ► SECTION 3 (CONTINUED) / SECCIÓN 3 (CONTINUACIÓN) / SECTION 3 (SUITE)

TOOLS AND HARDWARE REQUIRED / INSTRUMENTAL Y HERRAJE REQUERIDOS / OUTILS ET QUINCAILLERIE REQUIS

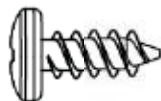

ADZ (x4)



• If you have trouble with this section, follow the code below to view a video on how to assemble these Gables.

• Si tiene problemas con esta sección, siga el código debajo para ver un video sobre el ensamble de estas Fachadas.

• Si vous avez des problèmes avec cette section, suivez le code en bas pour voir un vidéo sur l'assemblage de ces Pignons.



<http://go.lifetime.com/8gable>

### 3.1

• Align the holes in the **Left (AGH)** and **Right (AGI)** Rear Gable Halves.

• Alinee los agujeros en las **Fachadas traseras izquierda (AGH)** y **derecha (AGI)**.

• Aligned les trous dans les **Pignons gauche (AGH)** et **droite (AGI)**.

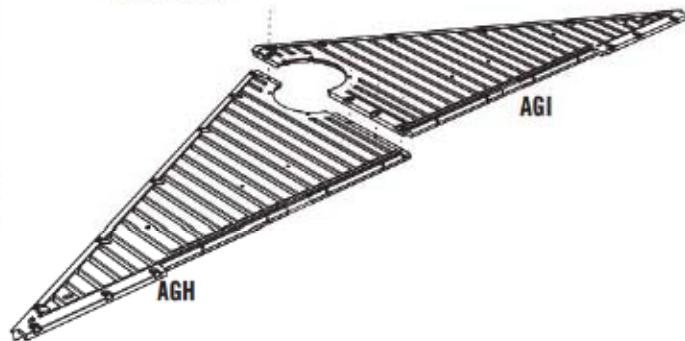

### 3.2

• Secure the two Gable Halves with four (4) **Screws (ADZ)**.

• Sujete el uno al otro usando cuatro (4) **Tornillos (ADZ)**.

• Attachez l'un à l'autre à l'aide de quatre (4) **Vis (ADZ)**.

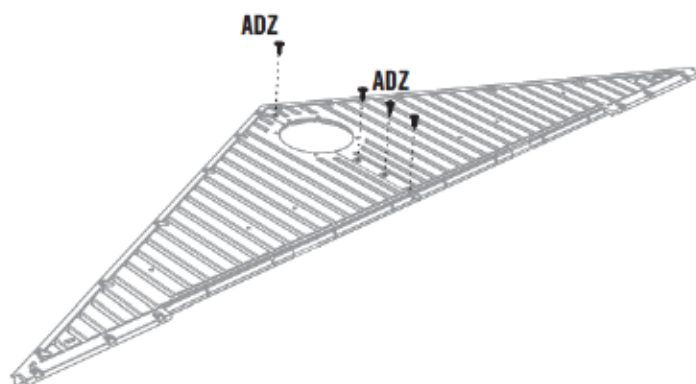

### 3.3

• Place the **Screen (AIQ)** over the **Vent (AGP)** and align the five holes in the Vent with those in the Gable.

• Coloque el **Mosquitero (AIQ)** sobre la **Rejilla de ventilación (AGP)** y alinee los agujeros en la Rejilla con los de la Fachada.

• Mettez la **Moustiquaire (AIQ)** sur l'**Évent (AGP)**, et alignez les cinq trous dans l'Évent avec ceux du Toit à pignon.

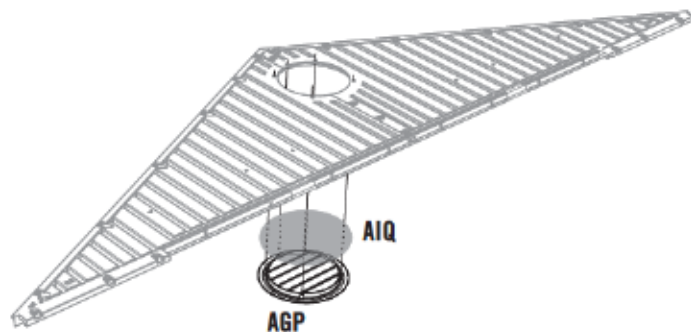

## ► SECTION 3 (CONTINUED) / SECCIÓN 3 (CONTINUACIÓN) / SECTION 3 (SUITE)

TOOLS AND HARDWARE REQUIRED / INSTRUMENTAL Y HERRAJE REQUERIDOS / OUTILS ET QUINCAILLERIE REQUIS



ADW (x10)



AEE (x10)



AHS (x2)

### 3.4

- Secure with the hardware included.
- Sujételos usando el herraje incluido.
- Attachez-les à l'aide de la quincaillerie incluse.

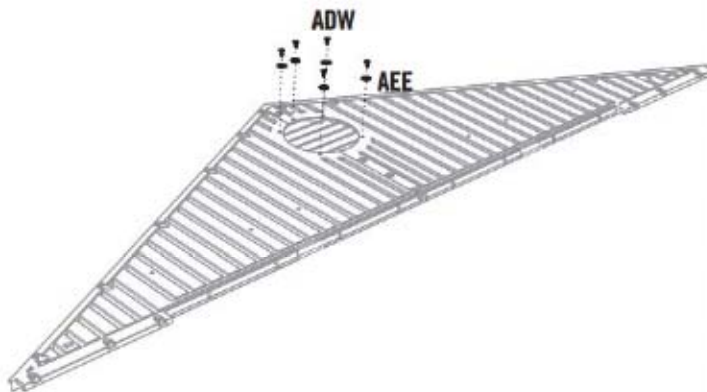

### 3.5

- Place the **Screen (AIQ)** over the **Vent (AGP)** and align the five holes in the Vent with those in the **Entry Gable (AGF)**.
- Coloque el **Mosquitero (AIQ)** sobre la **Rejilla de ventilación (AGP)** y alinee los agujeros en la Rejilla con los de la **Fachada de entrada (AGF)**.
- Mettez la **Moustiquaire (AIQ)** sur l'**Évent (AGP)**, et alignez les cinq trous dans l'Évent avec ceux du **Pignon d'entrée (AGF)**.

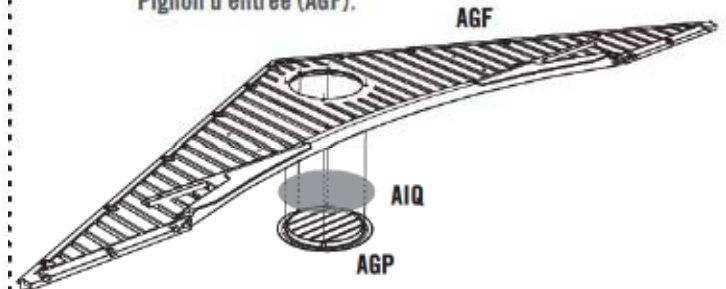

### 3.6

- Secure with the hardware included.
- Sujételos usando el herraje incluido.
- Attachez-les à l'aide de la quincaillerie incluse.

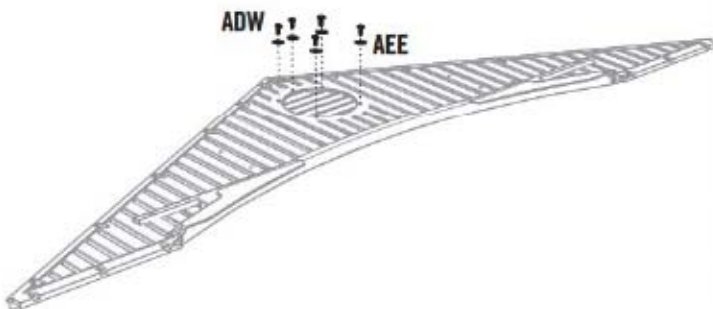

### 3.7

- Insert an **End Cap (AHS)** into each end of the **Header (AFE)**.
- Inserte un **Tapón (AHS)** en los dos extremos del **Dintel (AFE)**.
- Insérez un **Capuchon (AHS)** dans chaque extrémité du **Linteau (AFE)**.

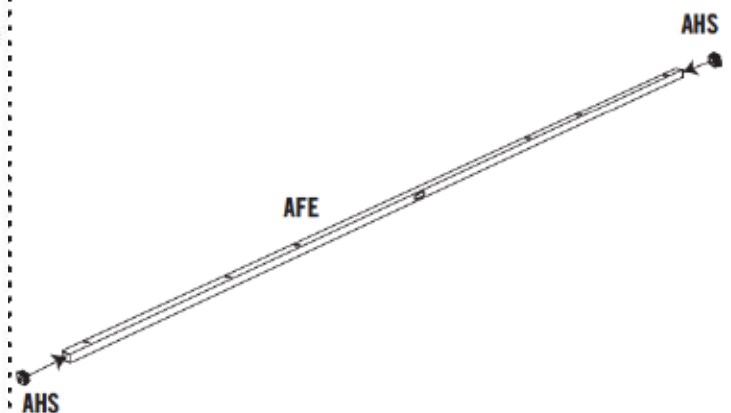

## ► SECTION 3 (CONTINUED) / SECCIÓN 3 (CONTINUACIÓN) / SECTION 3 (SUITE)

TOOLS AND HARDWARE REQUIRED / INSTRUMENTAL Y HERRAJE REQUERIDOS / OUTILS ET QUINCAILLERIE REQUIS

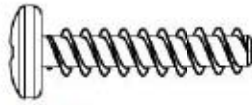

ADV (x6)

### 3.8

- Align the holes in the Header with those in the Gable.
- Alinee los agujeros en el Dintel con ellos en la Fachada.
- Alignez les trous dans le Linteau avec ceux du Pignon.



*Note: The flat holes face away from the Gable.*

*Nota: Los agujeros planos dan hacia afuera.*

*Note: Les trous plats doivent être face à l'écart du Pignon.*

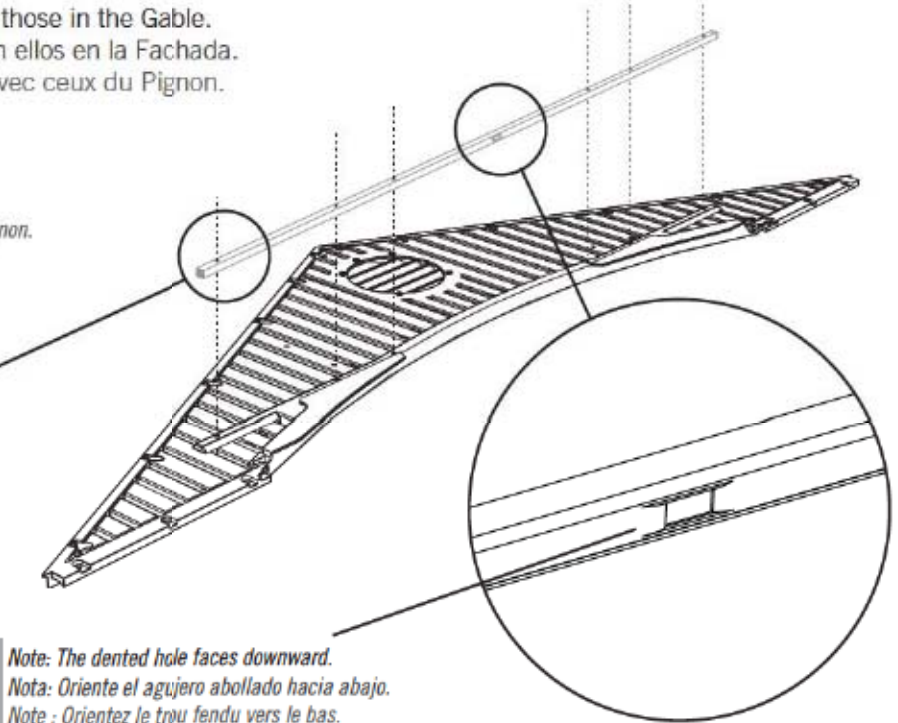
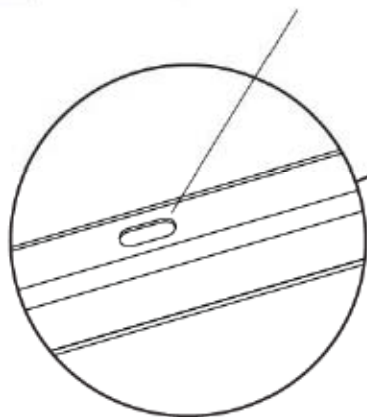

*Note: The dented hole faces downward.*

*Nota: Oriente el agujero abollado hacia abajo.*

*Note: Orientez le trou fendu vers le bas.*

### 3.9

- Secure with the hardware included.
- Sujételo usando el herraje incluido.
- Attachez-le à l'aide de la quincaillerie incluse.

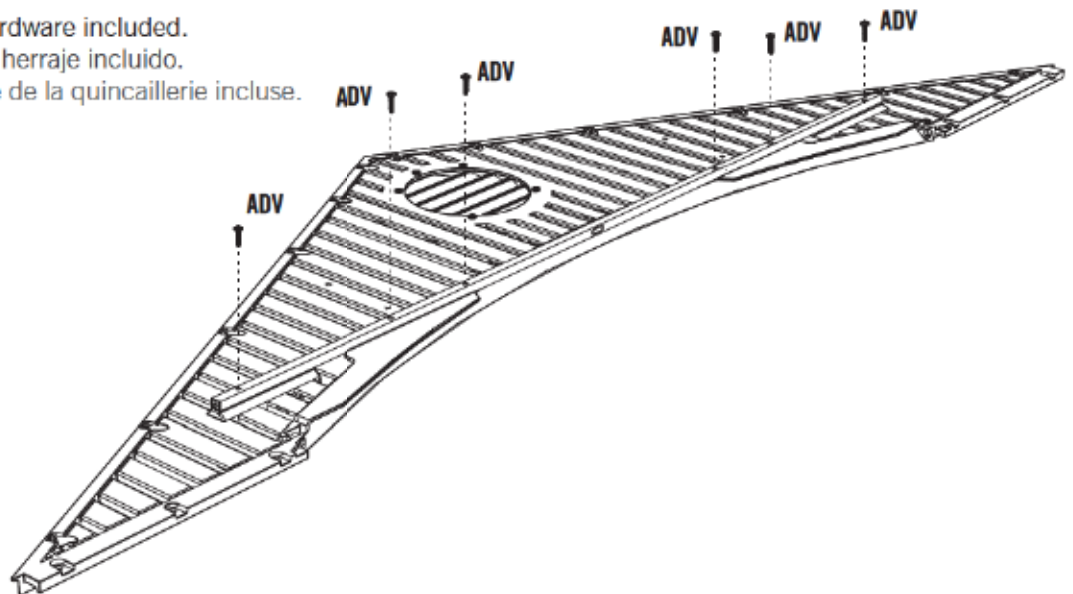

# 4 LEFT DOOR ASSEMBLY / ENSAMBLE DE LA PUERTA IZQUIERDA / ASSEMBLAGE DE LA PORTE GAUCHE



## HARDWARE REQUIRED / HERRAJE REQUERIDO / QUINCAILLERIE REQUISE

Hardware Bag / Bolsa de herraje / Sac de quincaillerie

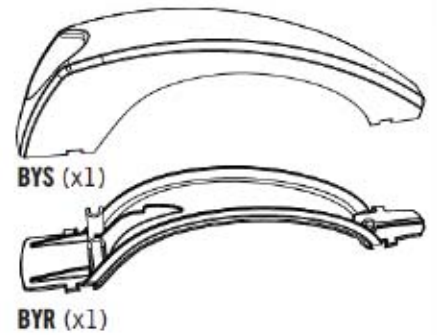
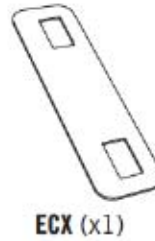
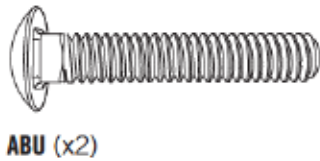
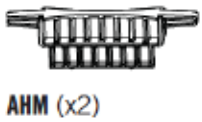
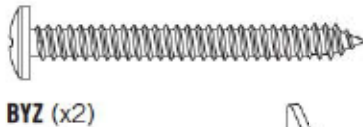
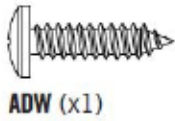

## PARTS REQUIRED / PIEZAS REQUERIDAS / PIÈCES REQUISES

Metal Parts / Piezas de metal / Pièces en métal

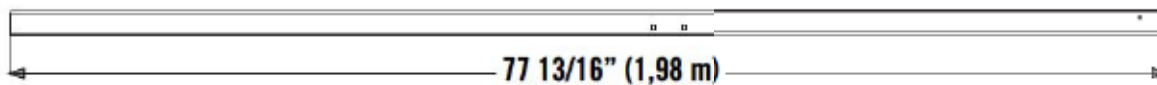

BLH (x1)

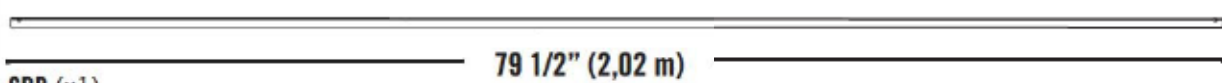
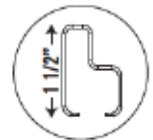

CRD (x1)



Plastic Parts / Piezas de plástico / Pièces en plastique

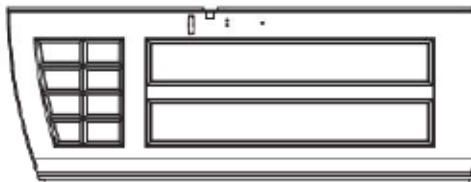

AGO (x1)



## TOOLS REQUIRED / INSTRUMENTAL REQUERIDO / OUTILS REQUIS



7/16"  
(11 mm)



## ► SECTION 4 (CONTINUED) / SECCIÓN 4 (CONTINUACIÓN) / SECTION 4 (SUITE)

TOOLS AND HARDWARE REQUIRED / INSTRUMENTAL Y HERRAJE REQUERIDOS / OUTILS ET QUINCAILLERIE REQUIS



AHM (x2)



- If you have trouble with this section, follow the code below to view a video on how to assemble the Left Door.
- Si tiene problemas con esta sección, siga el código debajo para ver un video sobre el ensamblaje de la Puerta izquierda.
- Si vous avez des problèmes avec cette section, suivez le code en bas pour voir un vidéo sur l'assemblage de la Porte gauche.



<http://go.lifetime.com/leftdoornewlatch>

### 4.1

- Slide a Hinge Tube (CRD) down into the hole at the top of the Left Door (AGO).
- Deslice el Tubo de articulación (CRD) en el agujero a la parte superior de la Puerta izquierda (AGO).
- Glissez le Tube d'articulation (CRD) dans le trou au bord supérieur de la Porte gauche (AGO).

CRD

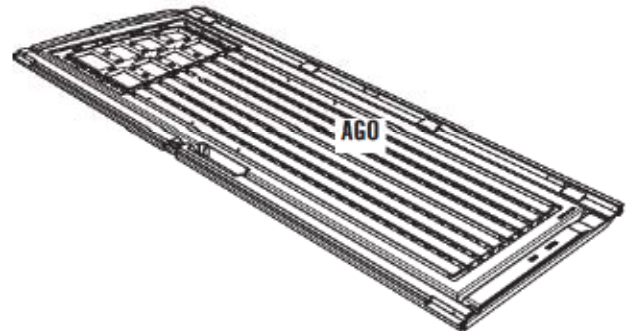

- Door Channels (BLH) are bowed by design, ensuring a tight fit when they are closed and latched, and making your shed more secure. These channels are formed with a slight bend to the adjoining door edge—like parentheses facing each other: ( ). When the door handle is gently closed and latched, there should be a slight pressure sealing the doors and eliminating any gaps. Be sure to read the step-by-step instructions carefully to successfully install the door channels.
- Los Canales para el borde de las puertas (BLH) son curvados por diseño, asegurando un ajuste fijo cuando las puertas estén cerrados con pestillo, y haciendo su caseta más segura. Estos Canales están formados con una curva ligera al borde de la puerta adyacente, como los paréntesis uno enfrente al otro: ( ). Cuando el picoporte esté ligeramente cerrado con pestillo, debería tener una presión ligera sellando las puertas y eliminando los espacios. Asegúrese de leer detenidamente las instrucciones paso a paso para poder instalar exitosamente los canales para el borde de las puertas.
- Les Canaux pour le bord des portes (BLH) sont courbés par dessein, en s'assurant un ajustage lorsque les portes se ferment, et en faisant votre abri plus sûr. Ces Canaux sont fabriqués avec une légère courbe au bord de la porte adjacent — comme les parenthèses qui font face l'une l'autre : ( ). Lorsque la poignée se ferme, il devrait un légère pression en rebouchant les portes et en éliminant des ouvertures. Assurez-vous de lire avec soin les instructions étape par étape pour pouvoir installer avec succès les canaux pour le bord des portes.



BLH

## ► SECTION 4 (CONTINUED) / SECCIÓN 4 (CONTINUACIÓN) / SECTION 4 (SUITE)

TOOLS AND HARDWARE REQUIRED / INSTRUMENTAL Y HERRAJE REQUERIDOS / OUTILS ET QUINCAILLERIE REQUIS



BYR (x1)



BYS (x1)

### 4.2

- Set the **Deadbolts (AHM)** down into the recesses at the top and bottom of the Door. Then, slide the **Door End Channel (BLH)** over the edge of the Door and the bottom of the Deadbolts as shown.
- Ponga los **Cerrojos (AHM)** en los huecos a las partes superior e inferior de la Puerta. Entonces, deslice el **Canal para el borde de la puerta (BLH)** sobre el borde de la Puerta y las partes inferiores de los Cerrojos como se muestra.
- Mettez les **Loquets à pêne dormant (AHM)** dans les espaces vides aux parties supérieure et inférieure de la Porte. Ensuite, faites glisser le **Canal de la porte (BLH)** sur le bord de la Porte et les parties inférieures des Loquets à pêne dormant comme illustré.

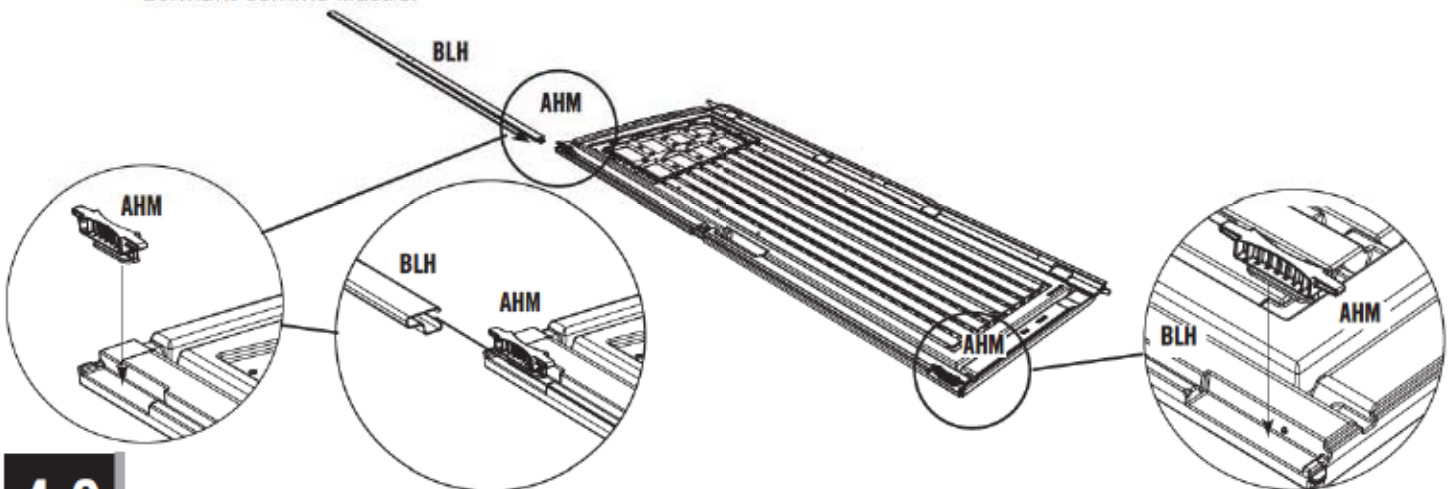

### 4.3

- Attach the two **Handle Pieces (BYR & BYS)** together as shown.
- Conecte las dos piezas del **Picaporte (BYR y BYS)** como se muestra.
- Attachez les deux pièces de la **Poignée (BYR et BYS)** comme illustré.

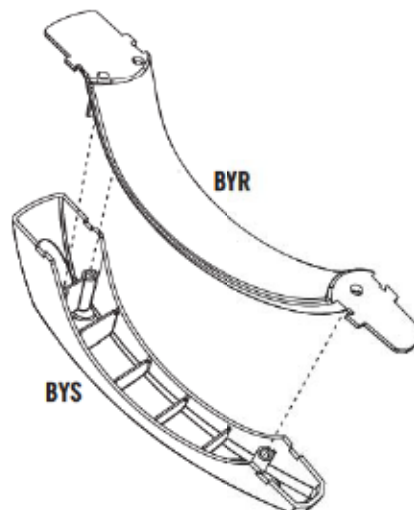

## ► SECTION 4 (CONTINUED) / SECCIÓN 4 (CONTINUACIÓN) / SECTION 4 (SUITE)

TOOLS AND HARDWARE REQUIRED / INSTRUMENTAL Y HERRAJE REQUERIDOS / OUTILS ET QUINCAILLERIE REQUIS

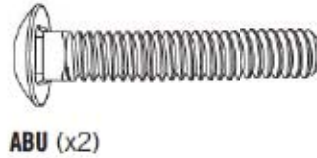
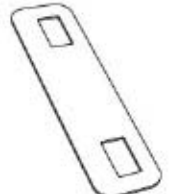
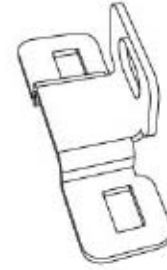
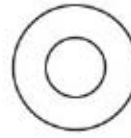
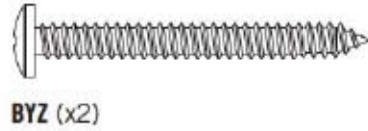
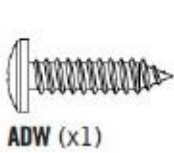

### 4.4

- Attach the Handle to the Door using the hardware included. **Do not overtighten.**
- Sujete el Picaporte a la Puerta usando el herraje incluido. **No apriete demasiado.**
- Attachez la Poignée à la Porte à l'aide de la quincaillerie incluse. **Ne pas trop serrer.**

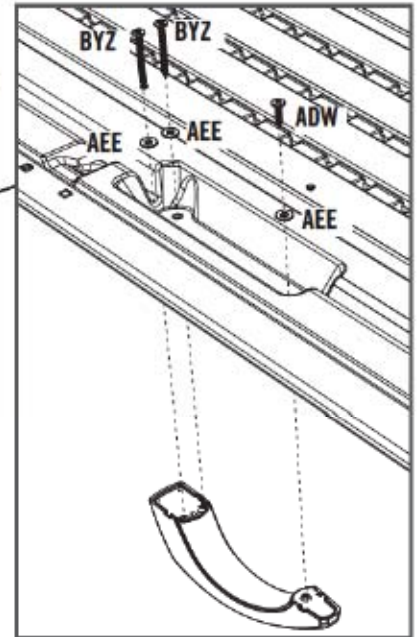
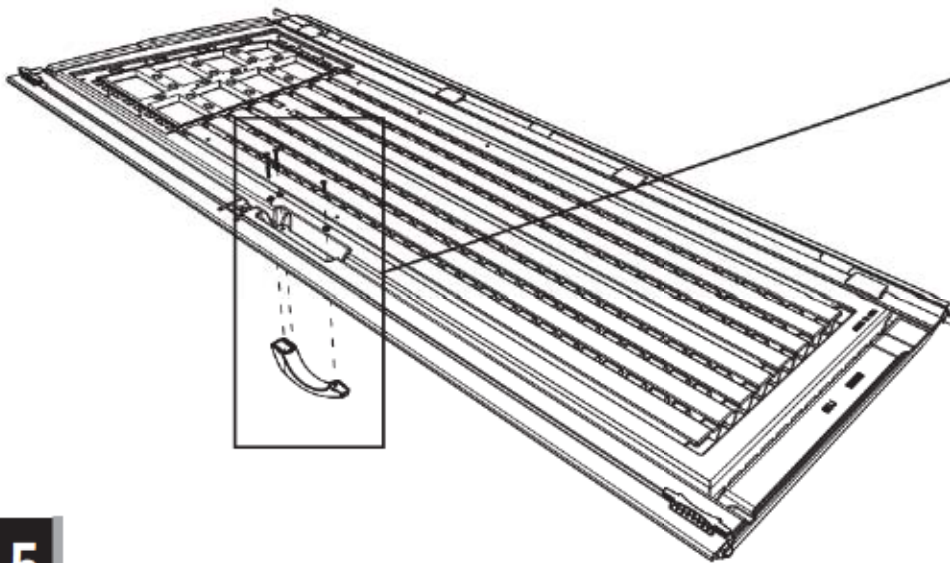

### 4.5

- Attach the **Strike Plate (ECX)** and **Lock Bracket (ECY)** to the Channel as shown. **Only hand-tighten the hardware for now.**
- Sujete la **Placa de impacto (ECX)** y el **Placa de cierre (ECY)** al Canal como se muestra. **Apriete los elementos sólo a mano en este momento.**
- Attachez la **Gâche (ECX)** et le **Plaque de verrouillage (ECY)** au Canal comme illustré. **Serrez la quincaillerie à la main seulement en ce moment.**

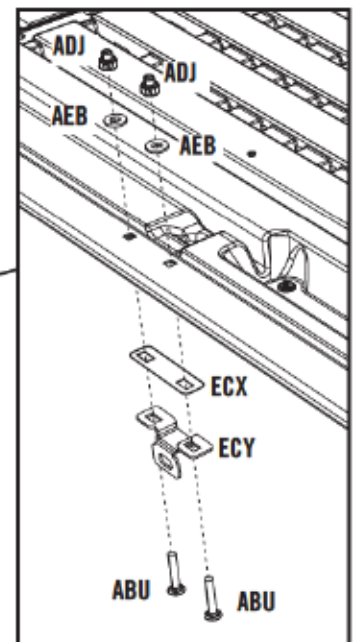
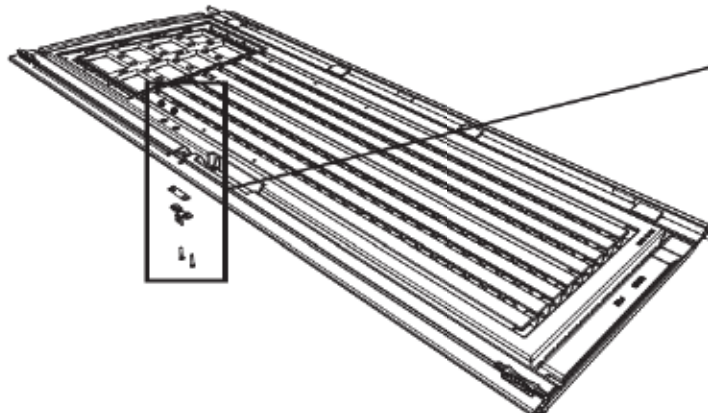



# 5

## RIGHT DOOR ASSEMBLY / ENSAMBLE DE LA PUERTA DERECHA / ASSEMBLAGE DE LA PORTE DROITE



### HARDWARE REQUIRED / HERRAJE REQUERIDO / QUINCAILLERIE REQUISE

Hardware Bag / Bolsa de herraje / Sac de quincaillerie

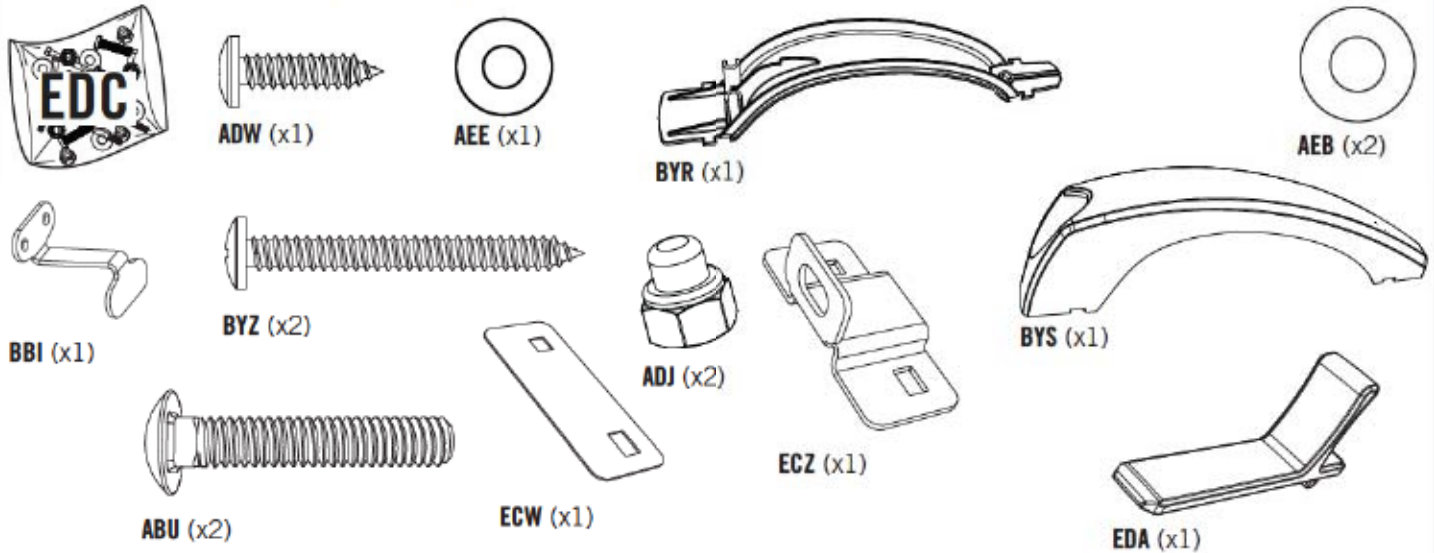

### PARTS REQUIRED / PIEZAS REQUERIDAS / PIÈCES REQUISES

Metal Parts / Piezas de metal / Pièces en métal

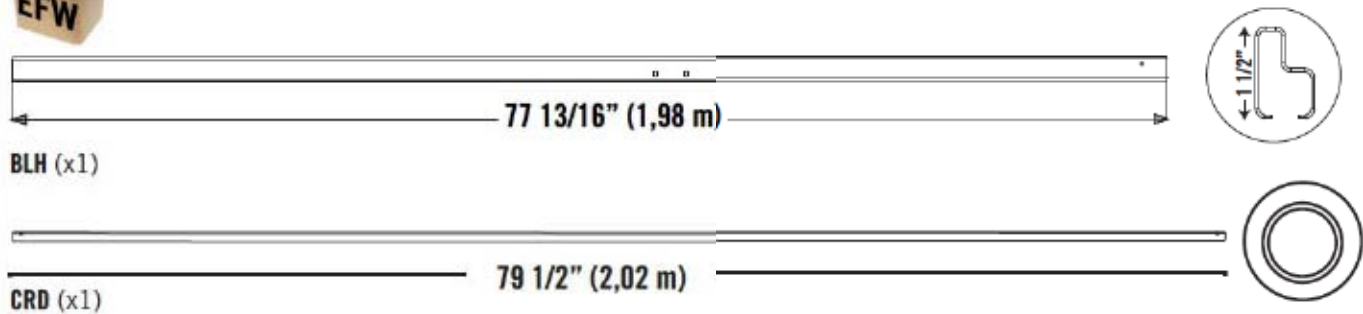

Plastic Parts / Piezas de plástico / Pièces en plastique

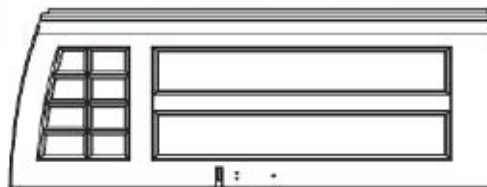

AGZ (x1)



### TOOLS REQUIRED / INSTRUMENTAL REQUERIDO / OUTILS REQUIS

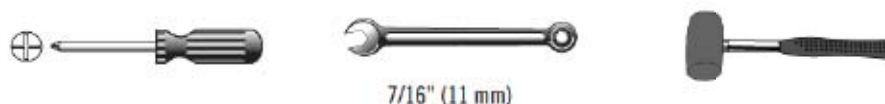

## ► SECTION 5 (CONTINUED) / SECCIÓN 5 (CONTINUACIÓN) / SECTION 5 (SUITE)

TOOLS AND HARDWARE REQUIRED / INSTRUMENTAL Y HERRAJE REQUERIDOS / OUTILS ET QUINCAILLERIE REQUIS



BYR (x1)



BY5 (x1)



- If you have trouble with this section, follow the code below to view a video on how to assemble the Right Door.
- Si tiene problemas con esta sección, siga el código debajo para ver un video sobre el ensamblaje de la Puerta derecha.
- Si vous avez des problèmes avec cette section, suivez le code en bas pour voir un vidéo sur l'assemblage de la Porte droite.



<http://go.lifetime.com/rightdoorslidelatch>

### 5.1

- Slide a **Hinge Tube (CRD)** down into the hole at the top of the **Right Door (AGZ)**.
- Deslice el **Tubo de articulación (CRD)** en el agujero a la parte superior de la **Puerta derecha (AGZ)**.
- Glissez le **Tube d'articulation (CRD)** dans le trou au bord supérieur de la **Porte droite (AGZ)**.

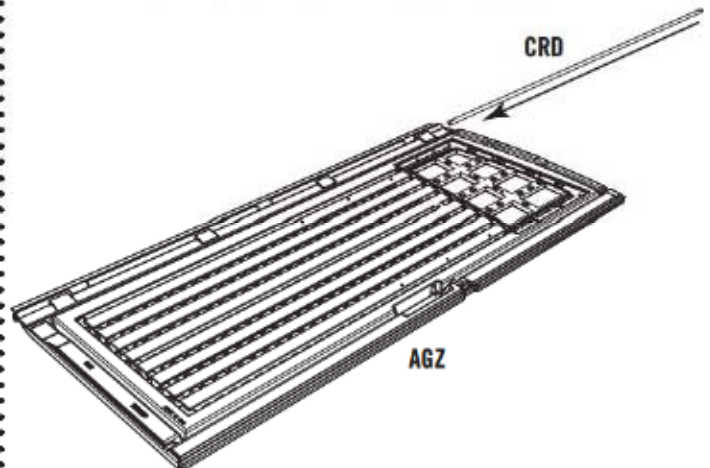

- **Door Channels (BLH)** are bowed by design, ensuring a tight fit when they are closed and latched, making your shed more secure. These channels are formed with a slight bend to the adjoining door edge—like parentheses facing each other: ( ). When the door handle is gently closed and latched, there should be a slight pressure sealing the doors and eliminating any gaps. Be sure to read the step-by-step instructions carefully to successfully install the door channels.
- Los Canales para el borde de las puertas (BLH) son curvados por diseño, asegurando un ajuste tijo cuando las puertas estén cerrados con pestillo, haciendo su caseta más segura. Estos Canales están formados con una curva ligera al borde de la puerta adyacente, como los paréntesis uno enfrente al otro: ( ). Cuando el picaporte esté ligeramente cerrado con pestillo, debería tener una presión ligera sellando las puertas y eliminando los espacios. Asegúrese de leer detenidamente las instrucciones paso a paso para poder instalar exitosamente los canales para el borde de las puertas.
- Les Canaux pour le bord des portes (BLH) sont courbés par dessein, en s'assurant un ajustage lorsque les portes se ferment, en faisant votre abri plus sûre. Ces Canaux sont fabriqués avec une légère courbe au bord de la porte adjacent — comme les parenthèses qui font face l'une l'autre : ( ). Lorsque la poignée se ferme, il devrait un légère pression en rebouchant les portes et en éliminant des ouvertures. Assurez-vous de lire avec soin les instructions étape par étape pour pouvoir installer avec succès les canaux pour le bord des portes.



## SECTION 5 (CONTINUED) / SECCIÓN 5 (CONTINUACIÓN) / SECTION 5 (SUITE)

TOOLS AND HARDWARE REQUIRED / INSTRUMENTAL Y HERRAJE REQUERIDOS / OUTILS ET QUINCAILLERIE REQUIS

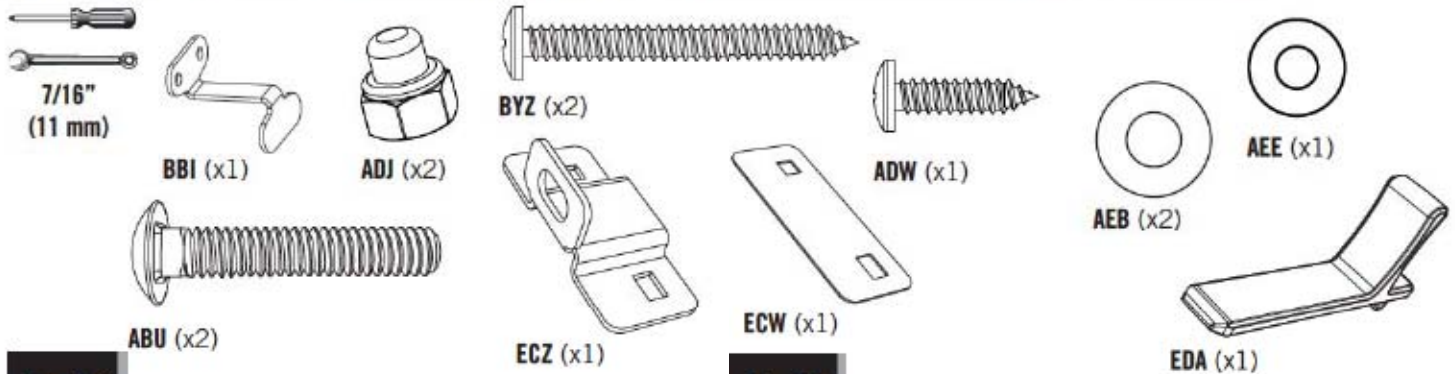

### 5.2

- Slide the **Door End Channel (BLH)** over the edge of the Door as shown.
- Deslice el **Canal para el borde de la puerta (BLH)** sobre el borde de la Puerta como se muestra.
- Faites glisser le **Canal de la porte (BLH)** sur le bord de la Porte comme illustré.

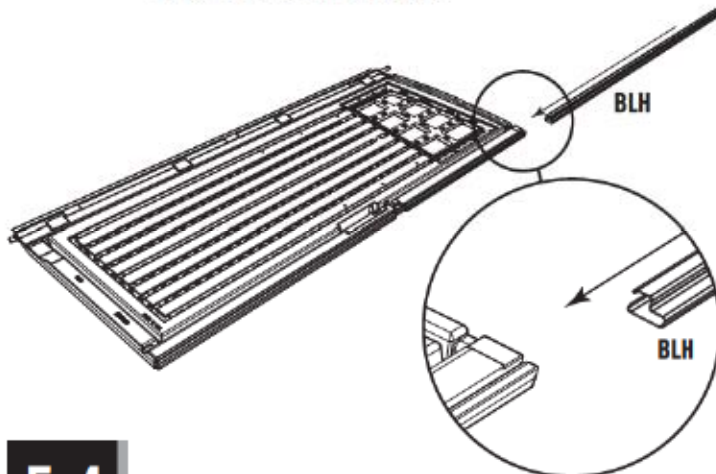

### 5.3

- Attach the two **Handle Pieces (BYR & BYS)** together as shown.
- Conecte las dos piezas del **Picaporte (BYR y BYS)** como se muestra.
- Attachez les deux pièces de la **Poignée (BYR et BYS)** comme illustré.

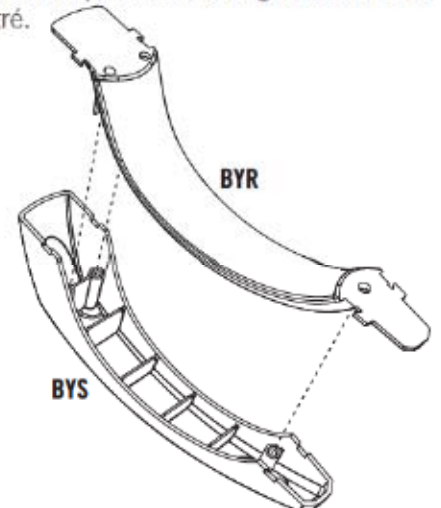

### 5.4

- Attach the Handle using the hardware included.
- Sujete el Picaporte usando el herraje incluido.
- Attachez la Poignée à l'aide de la quincaillerie incluse.

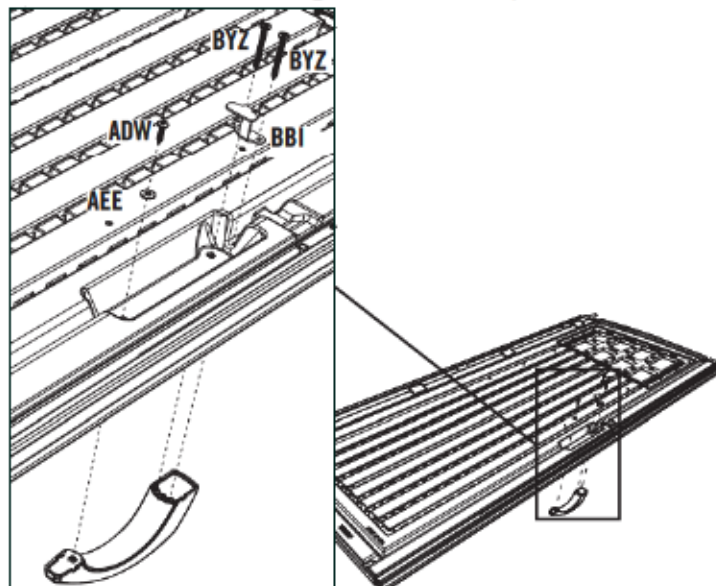

### 5.5

- Attach the Locking Hardware by hand only.
- Sujete los accesorios de cierre sólo a mano.
- N'attachez qu'à la main seulement la quincaillerie de verrouillage.

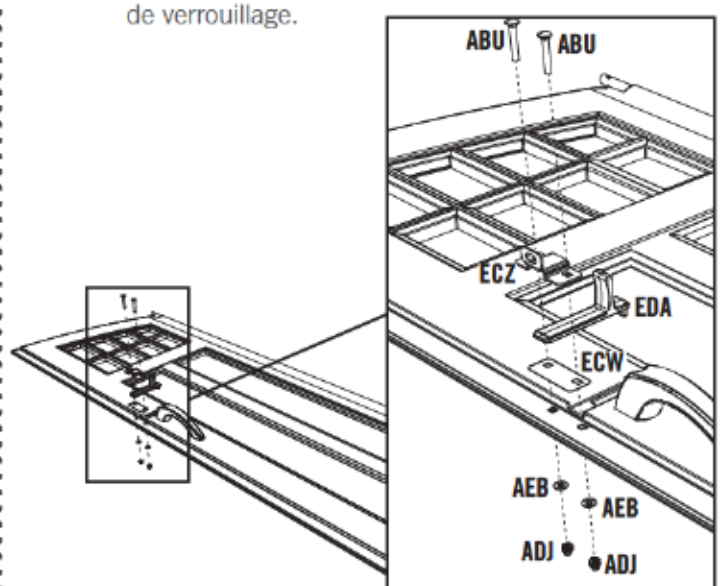

# 6

## FLOOR ASSEMBLY / ENSAMBLE DEL PISO / ASSEMBLAGE DU PLANCHER



### HARDWARE REQUIRED / HERRAJE REQUERIDO / QUINCAILLERIE REQUISE

Hardware Bags / Bolsas de herraje / Sacs de quincaillerie



**BQC** (x48)



**ADC** (x2)



**AHO** (x4)



*Note: These Screws do not anchor the Floor; they only hold the Panels together.*

*Nota: Estos Tornillos no anclan el Piso; sirven sólo para sujetar los Paneles los unos a los otros.*

*Note : Ces Vis n'ancrent pas le Plancher ; ils ne servent que pour attacher les Panneaux les uns aux autres.*



### PARTS REQUIRED / PIEZAS REQUERIDAS / PIÈCES REQUISES

Plastic Parts / Piezas de plástico / Pièces en plastique

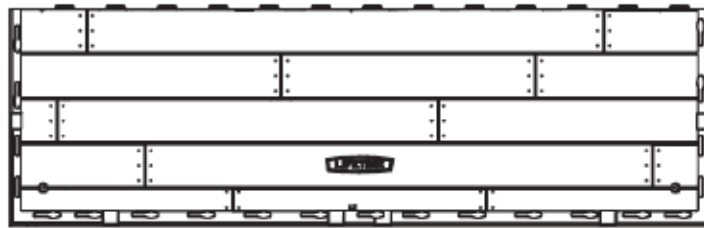

**CUW** (x2)

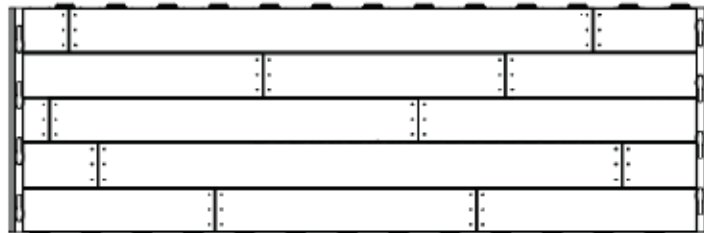

**CUD** (x6)



### TOOLS REQUIRED / INSTRUMENTAL REQUERIDO / OUTILS REQUIS



## ► SECTION 6 (CONTINUED) / SECCIÓN 6 (CONTINUACIÓN) / SECTION 6 (SUITE)

TOOLS AND HARDWARE REQUIRED / INSTRUMENTAL Y HERRAJE REQUERIDOS / OUTILS ET QUINCAILLERIE REQUIS



• If you have trouble with this section, follow the code below to view a video on how to assemble the Floor.

• Si tiene problemas con esta sección, siga el código debajo para ver un video sobre el ensamble del Piso.

• Si vous avez des problèmes avec cette section, suivez le code en bas pour voir un vidéo sur l'assemblage du Plancher.



<http://go.lifetime.com/8x20floorassembly>

### 6.1



- Hold an **Inner Floor Panel (CUD)** at a 45° angle and slide the tabs along the edge underneath an **Outer Floor Panel (CUW)**. The tabs interlock. Lay Panel flat.
- Coloque un **Panel de piso interior (CUD)** a un ángulo de 45° y deslice las lengüetas a lo largo del borde debajo el **Panel de piso exterior (CUW)**. Las lengüetas se entrelazan las unas con las otras. Aplane el Panel.
- Posez un **Panneau de plancher intérieur (CUD)** à un angle de 45° et glissez les languettes le long du bord au-dessus du **Panneau de plancher extérieur (CUW)**. Les languettes s'enclenchent les uns les autres. Étendez-le par terre.

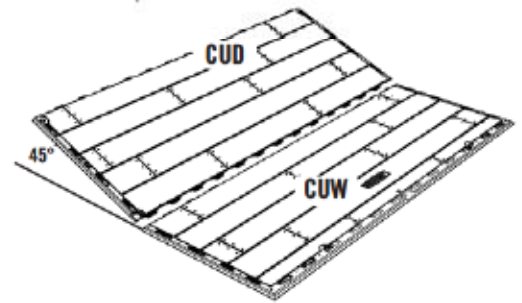

### 6.2

- Attach the second **Inner Floor Panel (CUD)** to the first Inner Floor Panel.
- Fije el segundo **Panel de piso interior (CUD)** al primer Panel de piso interior.
- Attachez le deuxième **Panneau de plancher intérieur (CUD)** au premier Panneau de plancher intérieur.

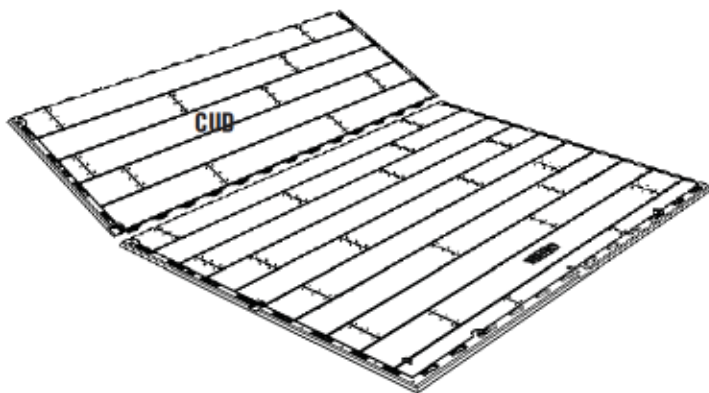

### 6.3

- Repeat the last step for the third Inner Floor Panel (CUD).
- Repita el paso anterior para el tercer Panel de piso interior (CUD).
- Répétez l'étape précédente pour le troisième Panneau de plancher intérieur (CUD).

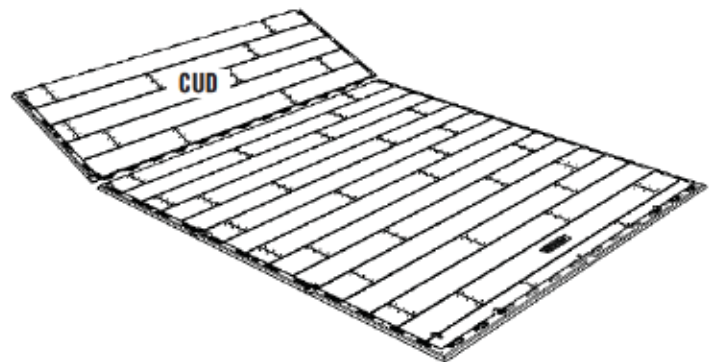

## ► SECTION 6 (CONTINUED) / SECCIÓN 6 (CONTINUACIÓN) / SECTION 6 (SUITE)

TOOLS AND HARDWARE REQUIRED / INSTRUMENTAL Y HERRAJE REQUERIDOS / OUTILS ET QUINCAILLERIE REQUIS



### 6.4

- Repeat the last step for the fourth, fifth, and sixth **Inner Floor Panels (CUD)**, followed by the **Outer Floor Panel (CUW)**.
- Repita el paso anterior para el tercer, cuarto, quinto, y sexto **Paneles de piso interiores (CUD)**, seguido por el **Panel de piso exterior (CUW)**.
- Répétez l'étape précédente pour le troisième, quatrième, cinquième, et sixième **Panneaux de plancher intérieurs (CUD)**, suivi par le **Panneau de plancher extérieur (CUW)**.

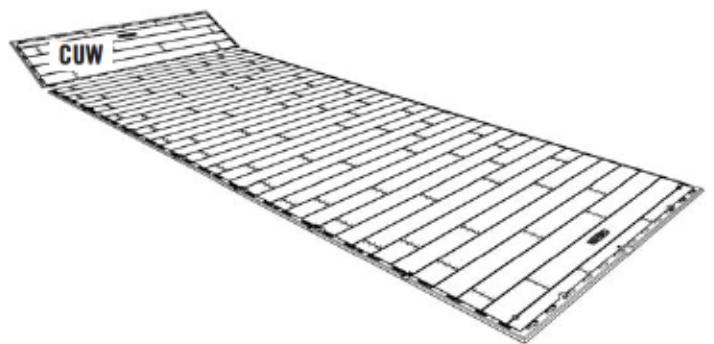
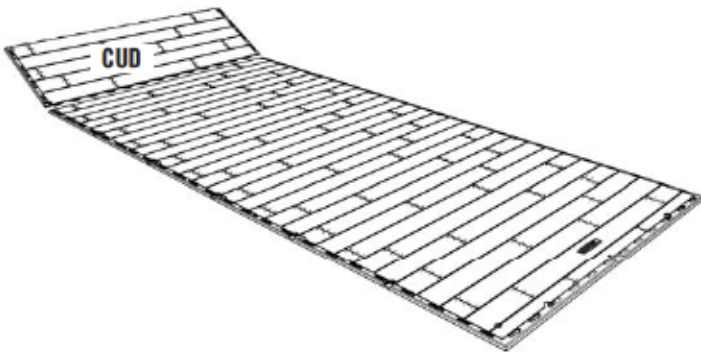
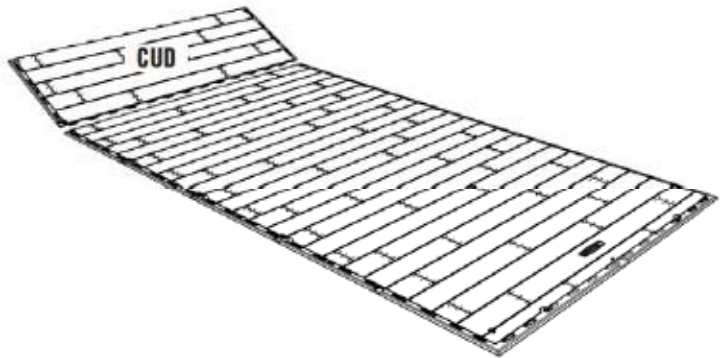
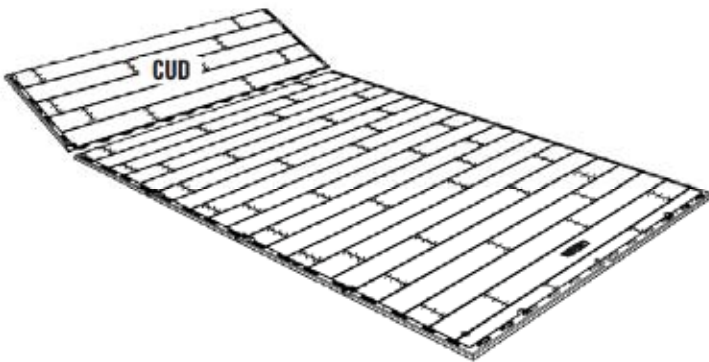

## ► SECTION 6 (CONTINUED) / SECCIÓN 6 (CONTINUACIÓN) / SECTION 6 (SUITE)

TOOLS AND HARDWARE REQUIRED / INSTRUMENTAL Y HERRAJE REQUERIDOS / OUTILS ET QUINCAILLERIE REQUIS



AHO (x2)

### 6.5

- Decide at which end you'd like to place your Doors, and insert the **Bushings (AHO)** up through the holes in the Floor Panels as shown. **You'll attach the Doors later.**
- Escoja el extremo donde le gustaría colocar las Puertas, e inserte los **Casquillos (AHO)** dentro de los agujeros en el Piso como se muestra. **Se sujetarán las Puertas más tarde.**
- Choisissez l'extrémité où vous voudrais placer les Portes, et insérez les **Bagues (AHO)** à travers les trous dans le Plancher comme illustré. **Vous attacherez les Portes plus tard.**

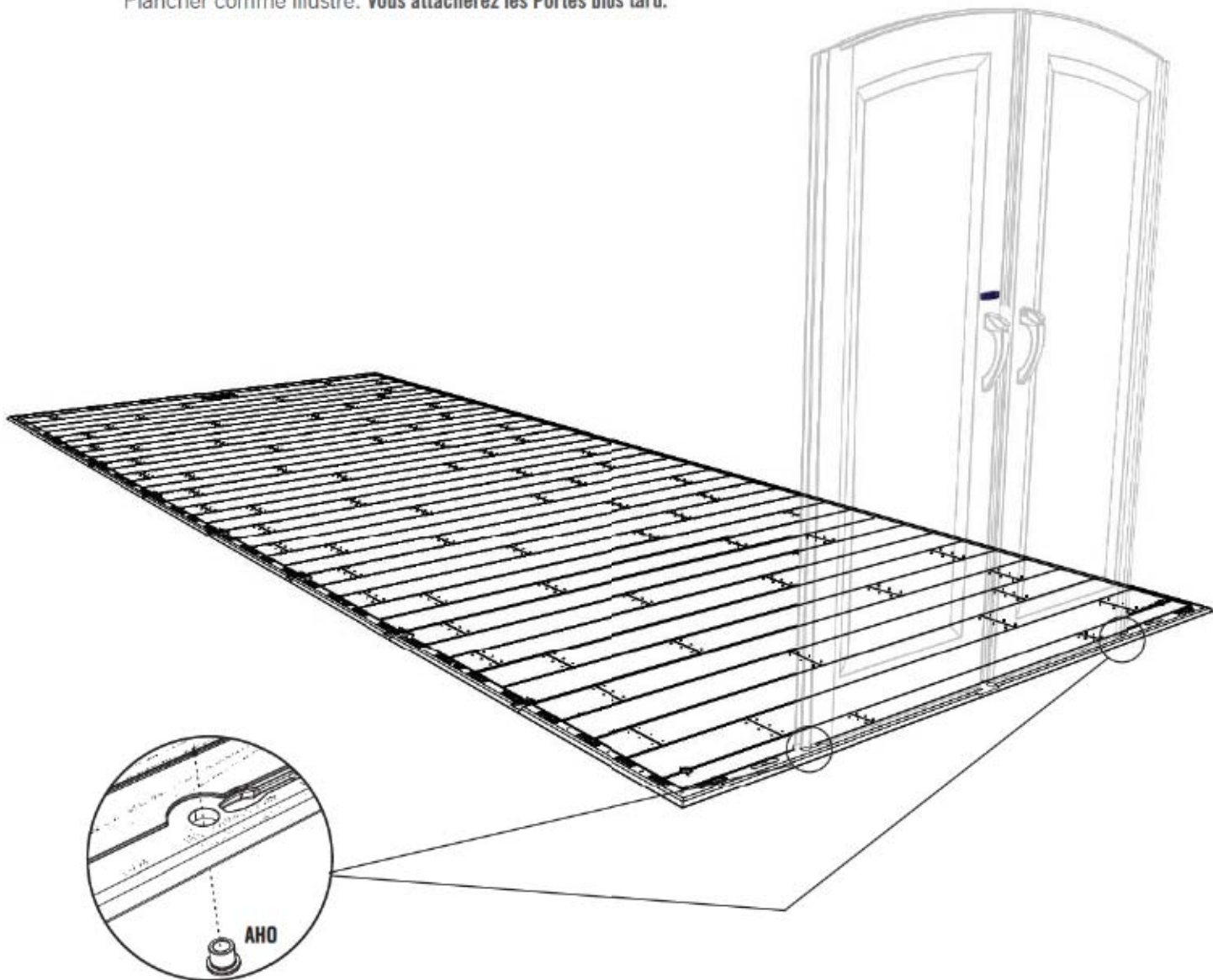

## ► SECTION 6 (CONTINUED) / SECCIÓN 6 (CONTINUACIÓN) / SECTION 6 (SUITE)

TOOLS AND HARDWARE REQUIRED / INSTRUMENTAL Y HERRAJE REQUERIDOS / OUTILS ET QUINCAILLERIE REQUIS

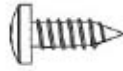

**BQC** (x42)

### 6.6

- Finally, insert the **Screws (BQC)** through the divots in the Floor Panels and into the tabs of the adjacent Floor Panels. (The divots are near the seams of the Floor Panels.)
- Por último, introduzca los **Tornillos (BQC)** a través de las marcas en los Paneles de piso y dentro de las lengüetas de los Paneles de piso adyacentes. (Se encuentran las marcas cerca de las juntas de los Paneles de piso.)
- Enfin, insérez les **Vis (BQC)** à travers les marques dans les Panneaux de plancher et dans les languettes du Panneaux de plancher contigu. (Les marques se trouvent près des jonctions des Panneaux de plancher.)

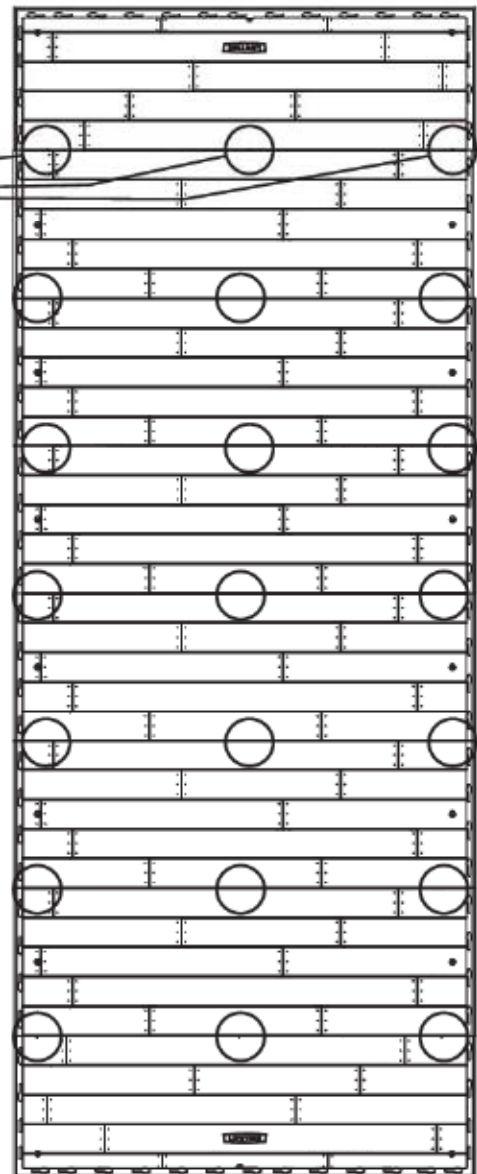
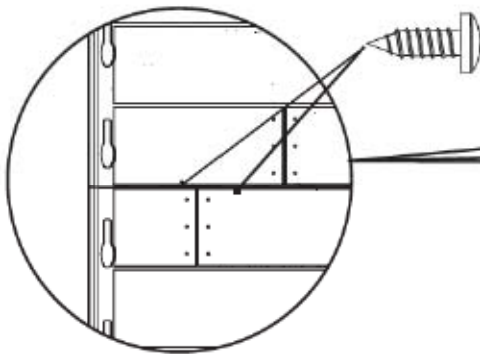

*Note: These Screws do not anchor the Floor; they only hold the Panels together.  
Nota: Estos Tornillos no anclan el Piso; sirven sólo para sujetar los Paneles los unos a los otros.  
Note : Ces Vis n'ancrent pas le Plancher ; ils ne servent que pour attacher les Panneaux les uns aux autres.*



# 7

## WALL ASSEMBLY / ENSAMBLE DE LOS MUROS / ASSEMBLAGE DES MURS



### HARDWARE REQUIRED / HERRAJE REQUERIDO / QUINCAILLERIE REQUISE

Hardware Bag / Bolsa de herraje / Sac de quincaillerie



ADZ (x100)



### PARTS REQUIRED / PIEZAS REQUERIDAS / PIÈCES REQUISES

Plastic Parts / Piezas de plástico / Pièces en plastique

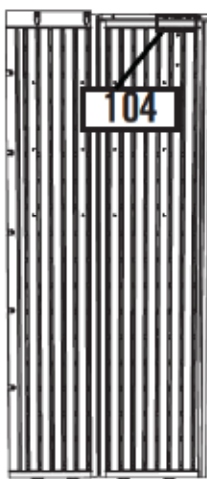

AGY (x1)

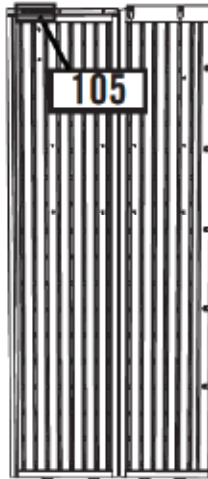

AGN (x1)

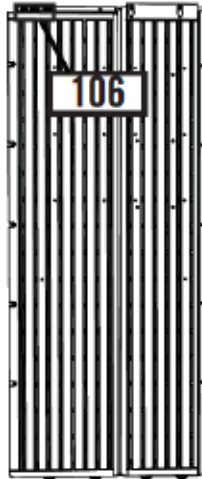

AGW (x1)

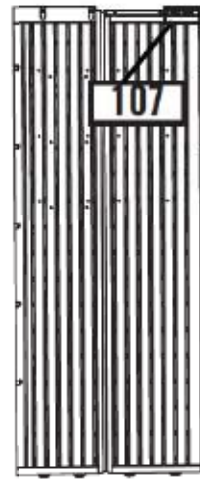

AGL (x1)



AHD (x14)



AHH (x2)



### TOOLS REQUIRED / INSTRUMENTAL REQUERIDO / OUTILS REQUIS



AIW (x1)



## ► SECTION 7 (CONTINUED) / SECCIÓN 7 (CONTINUACIÓN) / SECTION 7 (SUITE)

TOOLS AND HARDWARE REQUIRED / INSTRUMENTAL Y HERRAJE REQUERIDO / OUTILS ET QUINCAILLERIE REQUIS



- If you have trouble with this section, follow the code below to view a video on how to assemble the Walls.
- Si tiene problemas con esta sección, siga el código debajo para ver un video sobre el ensamble los Muros.
- Si vous avez des problèmes avec cette section, suivez le code en bas pour voir un vidéo sur l'assemblage des Murs.



<http://go.lifetime.com/8x20fwhorizwall>

### 7.1

- Insert the two left-most tabs at the bottom of the **Corner Panel (AGY)** into the two right-most slots along the edge of the Floor.
- Introduzca las lengüetas al borde inferior del **Panel angular (AGY)** en las ranuras a lo largo del borde del Piso.
- Insérez les deux languettes gauches au bord inférieur du **Panneau angulaire (AGY)** dans les deux rainures droites le long du bord du Plancher.

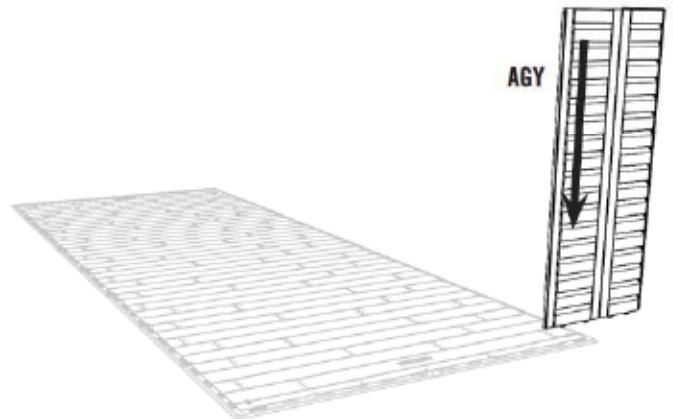

### 7.2

- Slide the Panel to the left.
- Deslice el Panel a la izquierda.
- Glissez le Panneau à gauche.

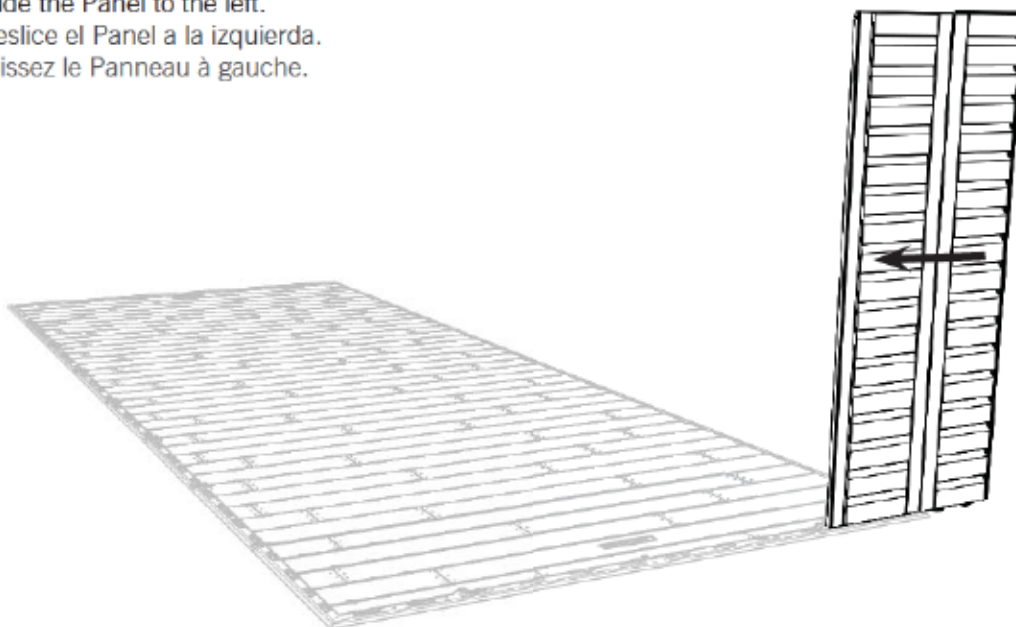

## ► SECTION 7 (CONTINUED) / SECCIÓN 7 (CONTINUACIÓN) / SECTION 7 (SUITE)

TOOLS AND HARDWARE REQUIRED / INSTRUMENTAL Y HERRAJE REQUERIDO / OUTILS ET QUINCAILLERIE REQUIS



### 7.3

- Bend Corner Panel and pull down on the Panel to snap the remaining tabs in place. To help with insertion, place the **Wood Block (AIW)** under the Floor Panel directly under the tab being inserted. You should hear a “click” when the tab pops into place. **Repeat this step for the second tab.**
- Doble el Panel angular e introduzca las lengüetas restantes. Para ayudar con el ensamble, deslice el **Bloque de madera (AIW)** debajo el Panel de piso directamente debajo la lengüeta que quiere insertar. Se escucha un «clic» cuando la lengüeta se sienta en su lugar. **Repita este proceso para la segunda lengüeta.**
- Pliez le Panneau angulaire et insérez les autres languettes. Pour aider avec le montage, mettez le **Bloque en bois (AIW)** sous le Panneau de plancher directement sous la languette que vous voulez insérer. **Répétez ce processus pour la deuxième languette.**

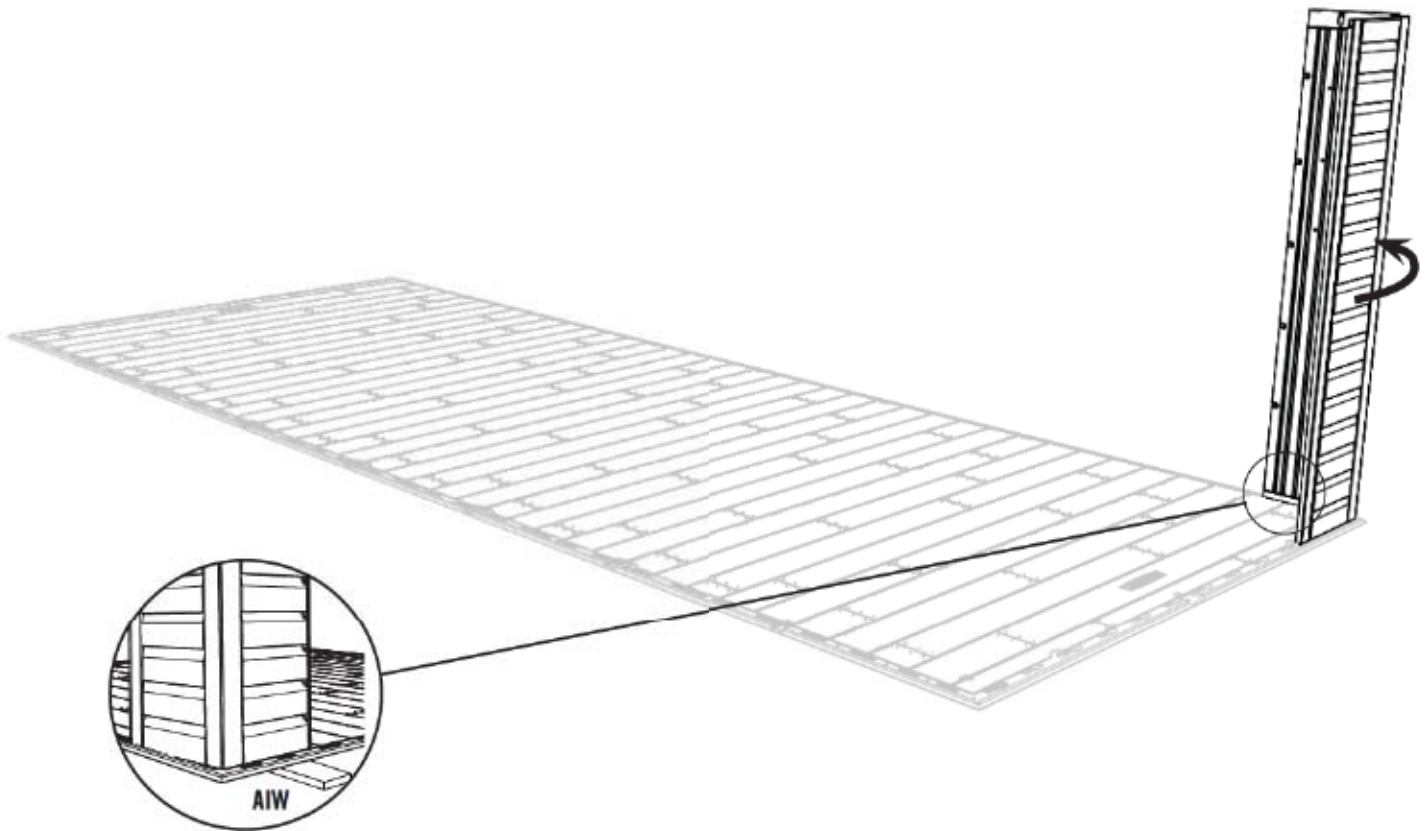

## ► SECTION 7 (CONTINUED) / SECCIÓN 7 (CONTINUACIÓN) / SECTION 7 (SUITE)

TOOLS AND HARDWARE REQUIRED / INSTRUMENTAL Y HERRAJE REQUERIDO / OUTILS ET QUINCAILLERIE REQUIS



AIW (x1)

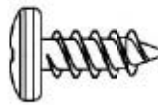

ADZ (x35)

### 7.4

• One at a time, insert the four tabs at the bottom of the **Wall Panels (AHD)** or **Window Wall Panels (AHH)** into the next four slots along the edge of the Floor, and slide the Panels forward. **Insert the Window Wall Panels on either side of the Shed.** You may need to use a rubber mallet and the block of wood to gently tap the Panel forward. Attach the Panels together with five (5) Screws (ADZ).

• Uno por uno, inserte las cuatro lengüetas al borde inferior de los **Paneles murales (AHD)** o **Paneles murales para la ventana (AHH)** en las cuatro ranuras siguientes a lo largo del borde del Piso, y deslice los Paneles hacia el borde delantero. **Inserte los Paneles murales para la ventana en cualquiera de los dos lados de la caseta.** Puede que necesite usar un mazo de goma y el bloque de madera para dar un golpecito al Panel para ubicar cuidadosamente el Panel en su lugar. Sujete los Paneles los unos a los otros usando cinco (5) Tornillos (ADZ).

• Un par un, insérez les quatre languettes au bord inférieur des **Panneaux muraux (AHD)** ou **Panneaux muraux pour la fenêtre (AHH)** dans les quatre rainures suivantes le long du bord du Plancher, et glissez les Panneaux vers le bord avant. **Insérez les Panneaux muraux pour la fenêtre soit le côté droit soit le côté gauche de l'abri.** Vous pouvez utiliser un maillet en caoutchouc et le bloc en bois pour mettre en place les Panneaux. Attachez les Panneaux l'un à l'autre à l'aide de cinq (5) Vis (ADZ).

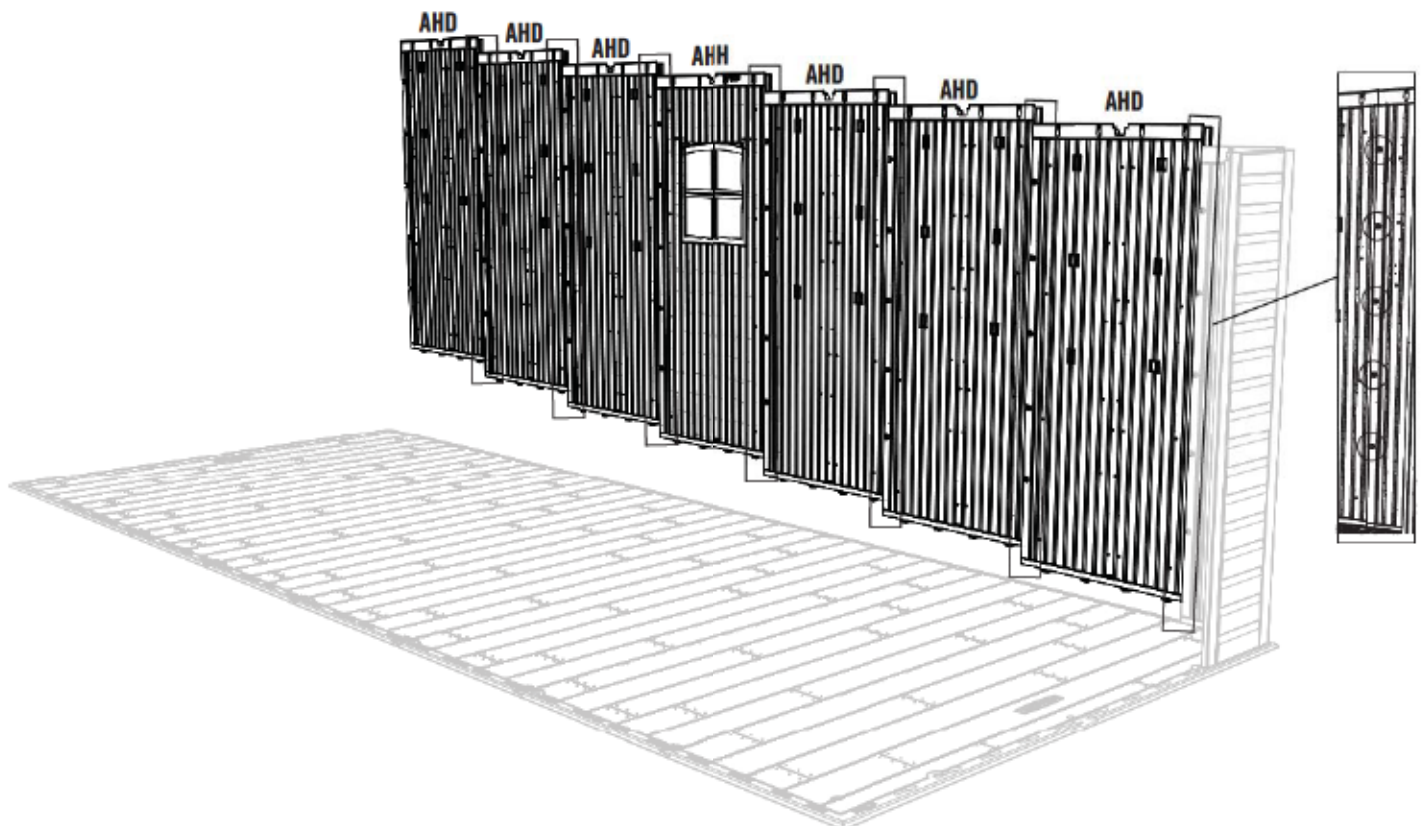

## ► SECTION 7 (CONTINUED) / SECCIÓN 7 (CONTINUACIÓN) / SECTION 7 (SUITE)

TOOLS AND HARDWARE REQUIRED / INSTRUMENTAL Y HERRAJE REQUERIDO / OUTILS ET QUINCAILLERIE REQUIS



AIW (x1)

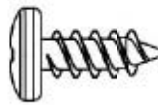

ADZ (x55)

### 7.5

- Insert this **Corner Wall Panel (AGW)** in the same way as the first one.
- Inserte este **Panel angular (AGW)** en la misma manera que el primer Panel angular.
- Insérez le **Panneau angulaire (AGW)** dans la même manière que le premier Panneau angulaire.

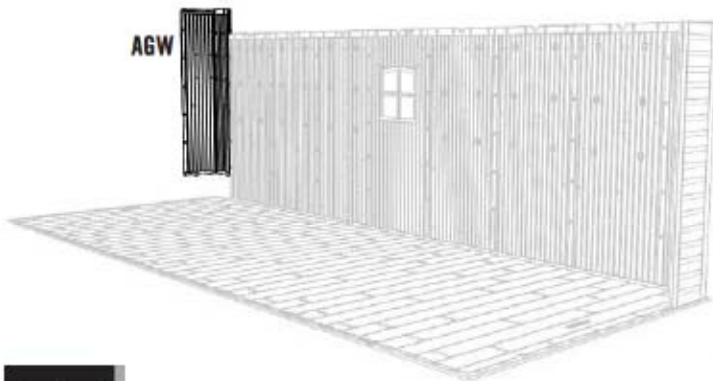

### 7.6

- Insert only **Wall Panels (AHD)** in the same way as the previous ones.
- Inserte sólo **Paneles murales (AHD)** en la misma manera que los Paneles anteriores.
- Insérez seulement les **Panneaux muraux (AHD)** dans la même manière que les Panneaux précédents.

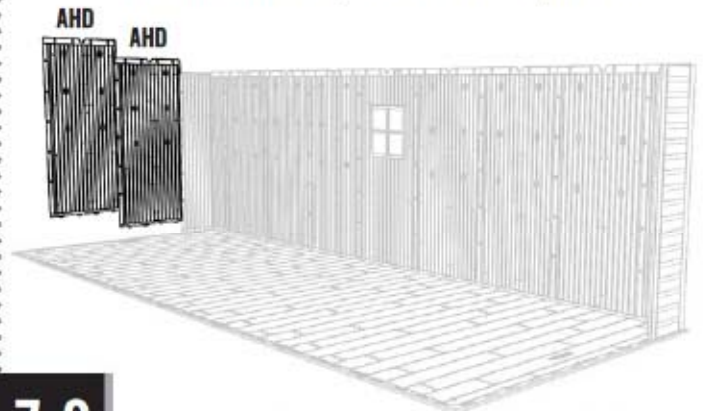

### 7.7

- Insert this **Corner Wall Panel (AGL)** in the same way as the first one.
- Inserte este **Panel angular (AGL)** en la misma manera que el primer Panel angular.
- Insérez le **Panneau angulaire (AGL)** dans la même manière que le premier Panneau angulaire.

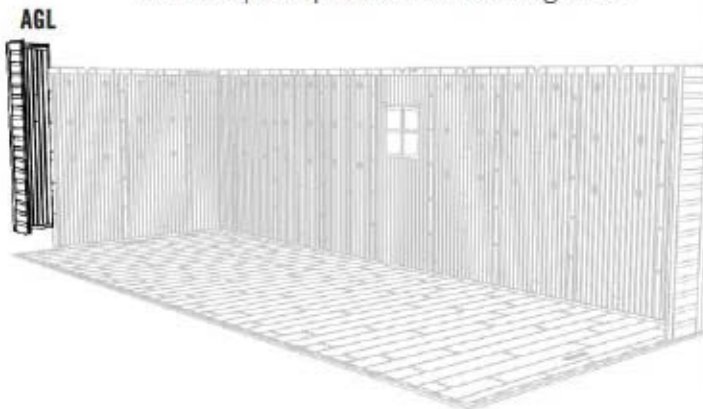

### 7.8

- Insert these Wall Panels in the same way as the other side. **The Window Wall Panels may be inserted on either side of the Shed.**
- Inserte estos Paneles murales en la misma manera que los del otro lado. **Se pueden insertar los Paneles murales para la ventana en cualquiera de los dos lados de la caseta.**
- Insérez ces Panneaux muraux dans la même manière que ceux de l'autre côté. **Vous pouvez insérer les Panneaux muraux pour la fenêtre soit le côté droit soit le côté gauche de l'abri.**

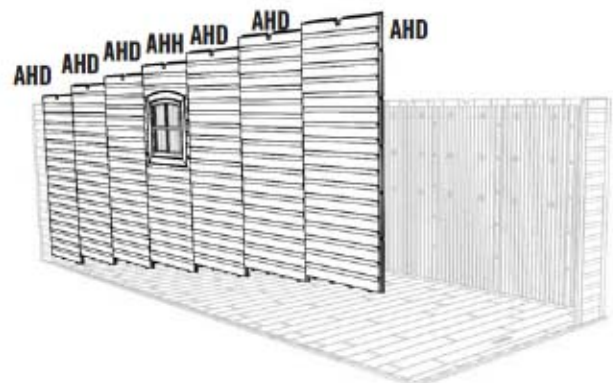

## ► SECTION 7 (CONTINUED) / SECCIÓN 7 (CONTINUACIÓN) / SECTION 7 (SUITE)

TOOLS AND HARDWARE REQUIRED / INSTRUMENTAL Y HERRAJE REQUERIDO / OUTILS ET QUINCAILLERIE REQUIS



AIW (x1)



ADZ (x5)

### 7.9

- Insert this **Corner Wall Panel (AGN)** in the same way as the first one.
- Inserte este **Panel angular (AGN)** en la misma manera que el primer Panel angular.
- Insérez le **Panneau angulaire (AGN)** dans la même manière que le premier Panneau angulaire.

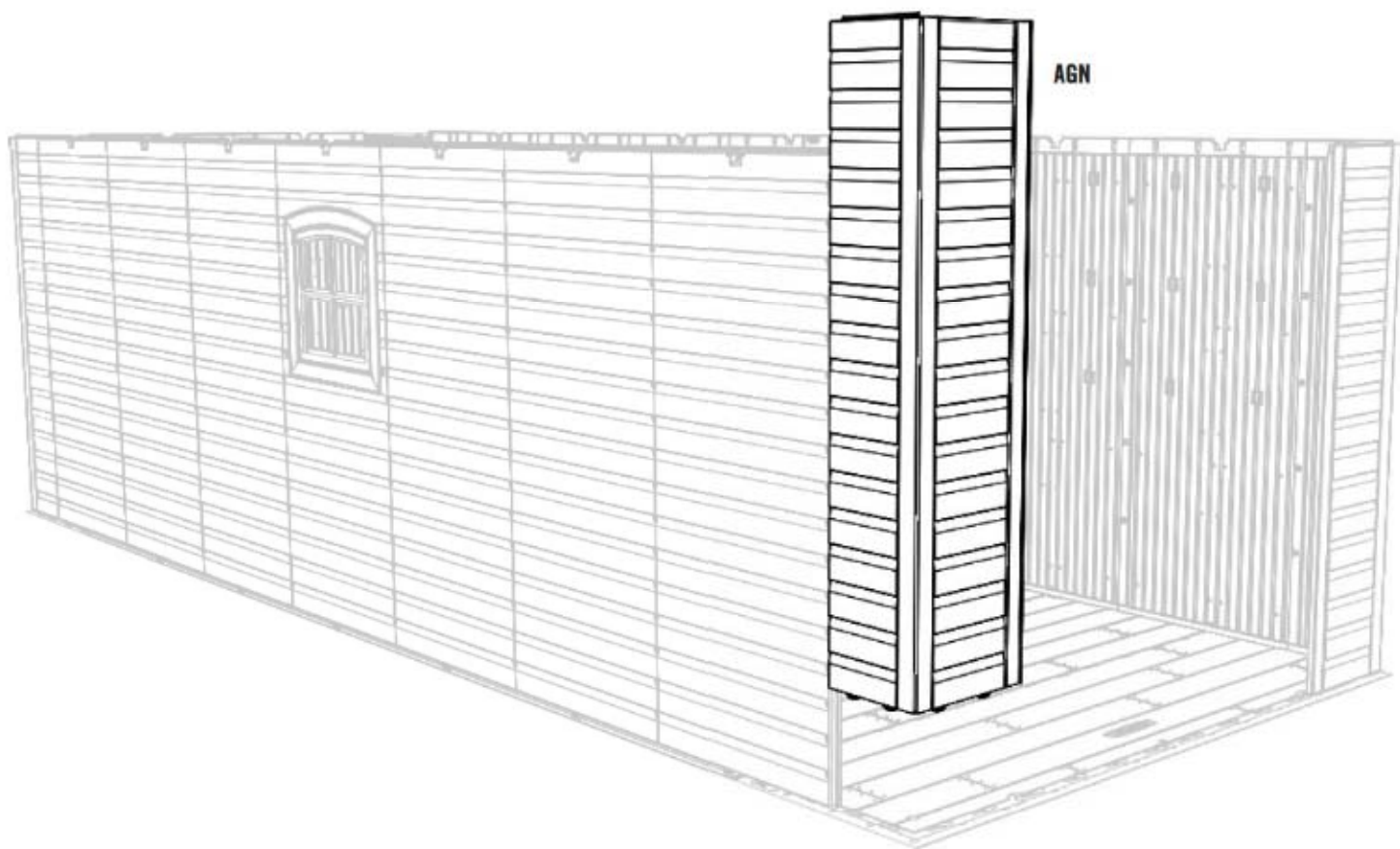

**HARDWARE REQUIRED / HERRAJE REQUERIDO / QUINCAILLERIE REQUISE**

Hardware Bag / Bolsa de herraje / Sac de quincaillerie

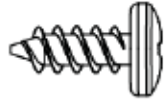

ADZ (x14)



AIY (x2)

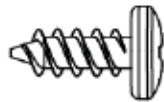

ADZ (x16)

**PARTS REQUIRED / PIEZAS REQUERIDAS / PIÈCES REQUISES**

Metal Parts / Piezas de metal / Pièces en métal

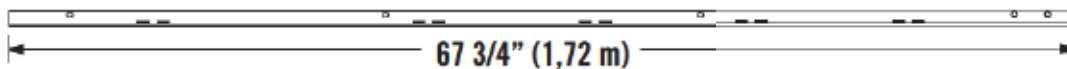

AFM (x2)



Plastic Parts / Piezas de plástico / Pièces en plastique

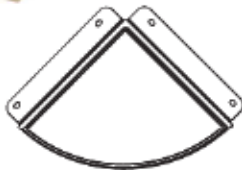

AFZ (x4)



AFV (x1)

**TOOLS REQUIRED / INSTRUMENTAL REQUERIDO / OUTILS REQUIS**

## ► SECTION 8 (CONTINUED) / SECCIÓN 8 (CONTINUACIÓN) / SECTION 8 (SUITE)

TOOLS AND HARDWARE REQUIRED / INSTRUMENTAL Y HERRAJE REQUERIDO / OUTILS ET QUINCAILLERIE REQUIS



ADZ (x8)



- If you have trouble with this section, follow the code below to view a video on how to install the Shelving.
- Si tiene problemas con esta sección, siga el código debajo para ver un video sobre la instalación de la Estantería.
- Si vous avez des problèmes avec cette section, suivez le code en bas pour voir un vidéo sur l'installation du rayonnage.



<http://go.lifetime.com/90shelf>

### 8.1

- The right **Wall/Shelf Support Channel (AFM)** goes in the slot directly under the notch in the Wall Panel. The left Wall Support Channel goes in the slot to the right of the notch in the Wall Panel.
- El **Canal de soporte para la pared/estante (AFM)** derecho se sujeta dentro de la ranura directamente debajo la muesca en el Panel de pared. El Canal de soporte para la pared izquierdo se sujeta dentro de la ranura a la derecha de la muesca en el Panel de pared.
- Le **Canal de support du mur/étagère (AFM)** droit s'attache dans la rainure directement sous l'encoche dans le Panneau mural. Le Canal de support du mur/étagère gauche s'attache dans la rainure à la droite de l'encoche du Panneau mural.

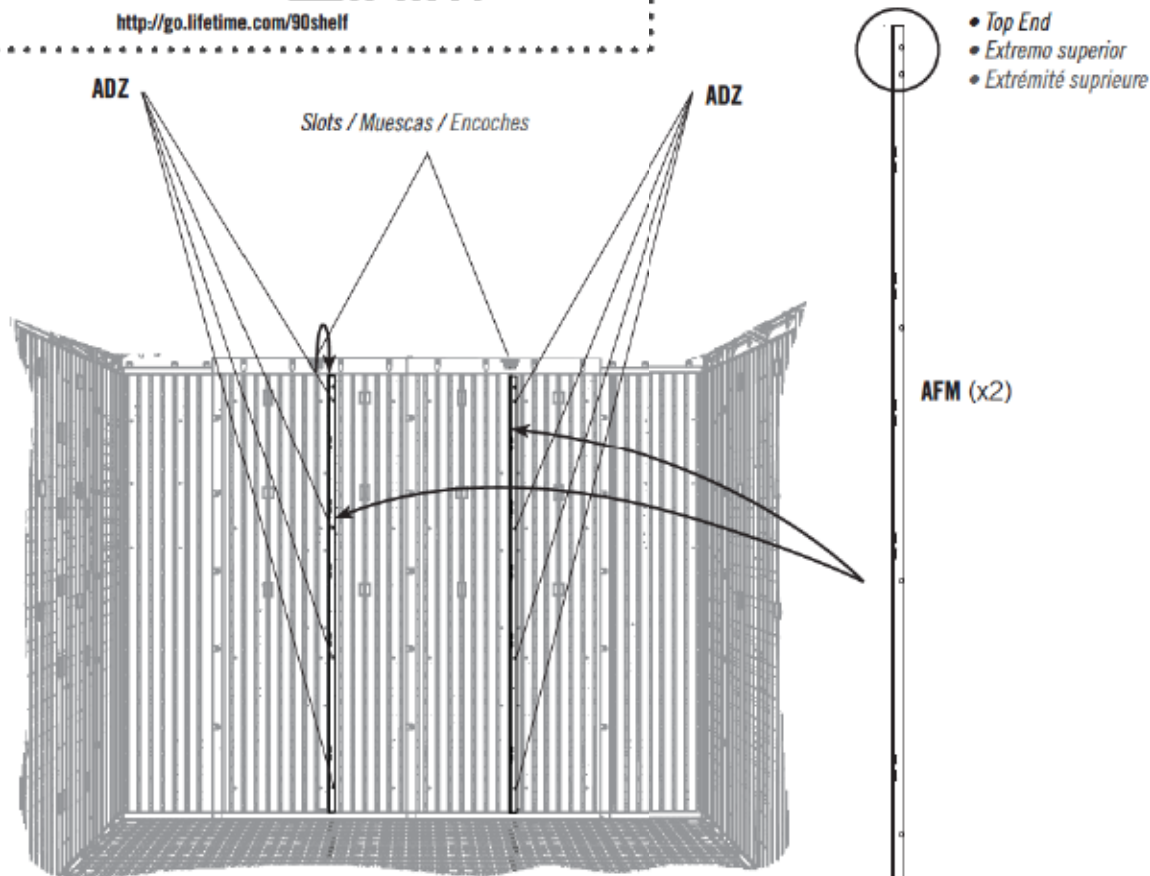



## ► SECTION 8 (CONTINUED) / SECCIÓN 8 (CONTINUACIÓN) / SECTION 8 (SUITE)

TOOLS AND HARDWARE REQUIRED / INSTRUMENTAL Y HERRAJE REQUERIDO / OUTILS ET QUINCAILLERIE REQUIS

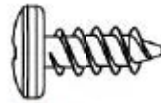

ADZ (x6)

### 8.2

- Insert the **Shelf Brackets (AIY)** into the slots in the Wall/Shelf Support Channels. **The Brackets must be at the same height.**
- Inserte las **Escuadras (AIY)** en las ranuras en los Canales de soporte para las Paredes/Estantes. **Las Escuadras deben estar a la misma altura.**
- Insérez les **Équerres (AIY)** dans les fentes dans les Canaux de support pour les Murs/Étagères. **Les Équerres doivent être à la même hauteur.**

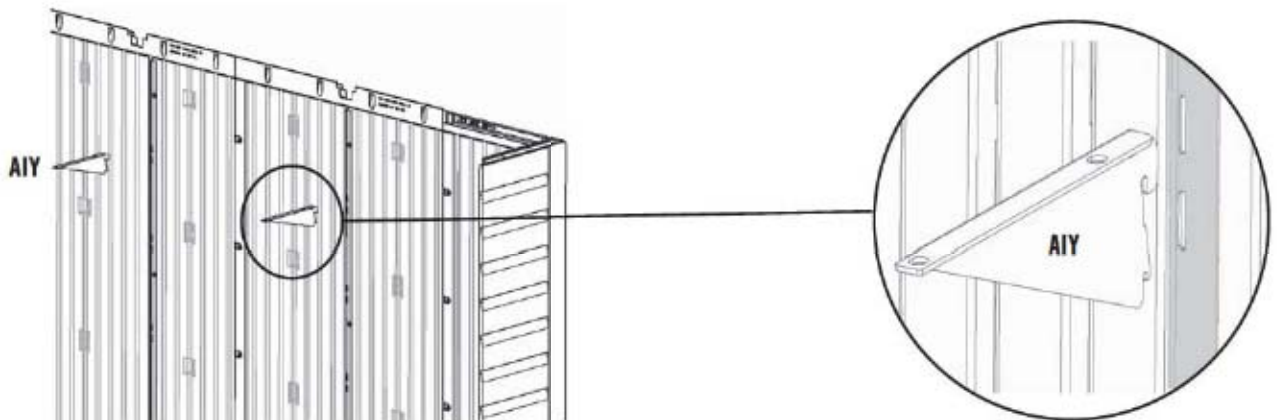

### 8.3

- Attach the **Shelf (AFV)** to the Corner Wall Panels and Shelf Brackets using six (6) **Screws (ADZ)**.
- Sujete el **Estante (AFV)** a los Paneles angulares y las Escuadras usando seis (6) **Tornillos (ADZ)**.
- Attachez l'Étagère (AFV) aux Panneaux angulaires et aux Équerres à l'aide de six (6) **Vis (ADZ)**.

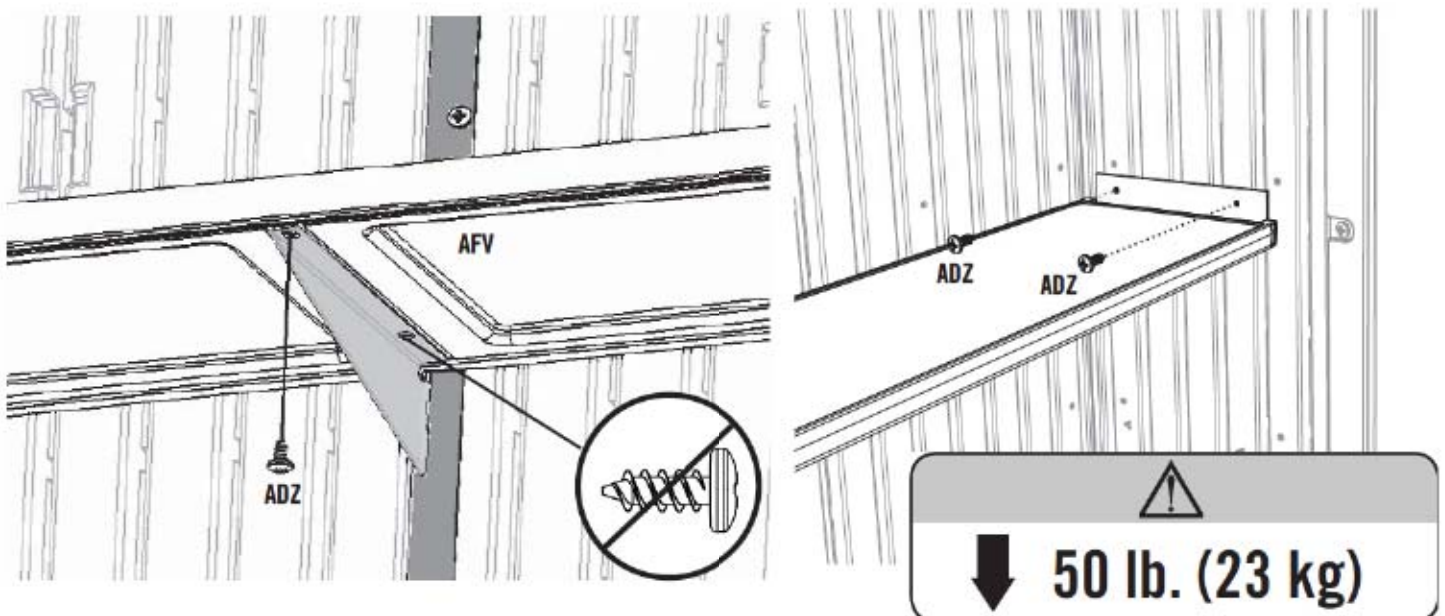

## ► SECTION 8 (CONTINUED) / SECCIÓN 8 (CONTINUACIÓN) / SECTION 8 (SUITE)

TOOLS AND HARDWARE REQUIRED / INSTRUMENTAL Y HERRAJE REQUERIDO / OUTILS ET QUINCAILLERIE REQUIS

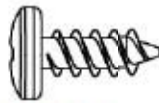

ADZ (x16)

### 8.4

- Select the corner in which you would like to install a **Corner Shelf (AFZ)**. There are three places for the Shelf in each corner. You may attach the Shelves in any corner. Avoid attaching the Corner Shelves too close to the Long Shelf. Fold up the flaps of the Shelf, and align the holes in the tabs with those in the Corner Wall Panel. Secure with four (4) **Screws (ADZ)**.
- Seleccione el rincón en el cual le gustaría instalar un **Estante angular (AFZ)**. Hay tres ubicaciones para el Estante en cada rincón. Se pueden sujetar los Estantes en cualquier rincón. Evite sujetarlos demasiado cerca el Estante largo. Pliegue las solapas del Estante, y alinee los agujeros en las solapas con ellos en el Panel mural angular. Sujete el Estante al Panel usando cuatro (4) **Tornillos (ADZ)**.
- Sélectionnez l'encoignure dans laquelle vous souhaitez installer une **Étagère angulaire (AFZ)**. Il y a trois emplacements pour l'Étagère en chaque encoignure. Vous pouvez les attacher à n'importe quelle encoignure. Évitez de les attacher trop proche à l'Étagère longue. Pliez les rabats de l'Étagère angulaire, et alignez les trous avec ceux du Panneau mural angulaire. Attachez l'Étagère au Panneau à l'aide de quatre (4) **Vis (ADZ)**.

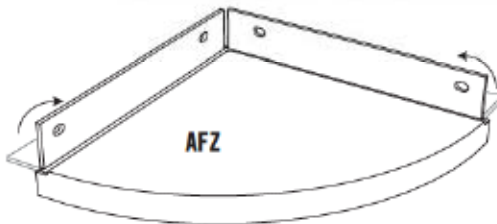

ADZ

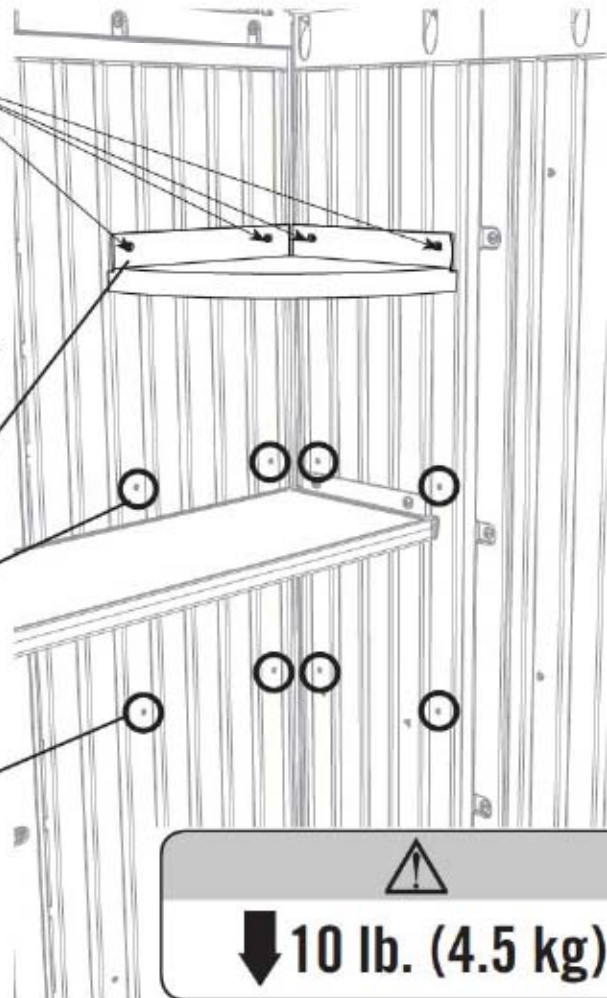

**!** Note: Repeat this step to place the remaining Corner Shelves in the corners of your choosing.

Nota: Repita este paso para sujetar los Estantes angulares restantes en los rincones de su preferencia.

Note: Répétez cette étape pour attacher les Étagères angulaires restantes dans les encoignures de votre choix.

• Place #1 / Ubicación N° 1 / Emplacement N° 1

• Place #2 / Ubicación N° 2 / Emplacement N° 2

• Place #3 / Ubicación N° 3 / Emplacement N° 3

  
↓ 10 lb. (4.5 kg)

# 9

## DOOR & ENTRY GABLE INSTALLATION / INSTALACIÓN DE LA FACHADA DE ENTRADA Y LAS PUERTAS / INSTALLATION DU TOIT À PIGNON ET LES PORTES



### HARDWARE REQUIRED / HERRAJE REQUERIDO / QUINCAILLERIE REQUISE

Hardware Bag / Bolsa de herraje / Sac de quincaillerie



ADX (x4)



AHP (x2)



ADZ (x6)

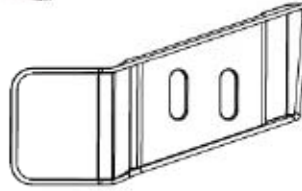

AIM (x1)

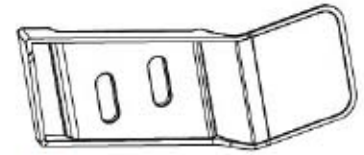

AIC (x1)



### PARTS REQUIRED / PIEZAS REQUERIDAS / PIÈCES REQUISES

Plastic Parts / Piezas de plástico / Pièces en plastique

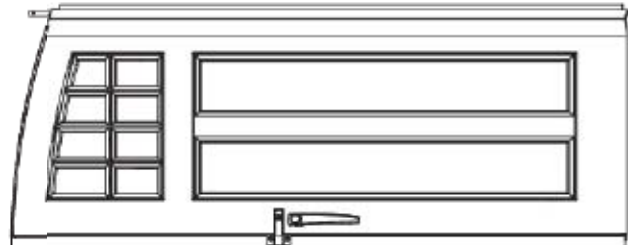
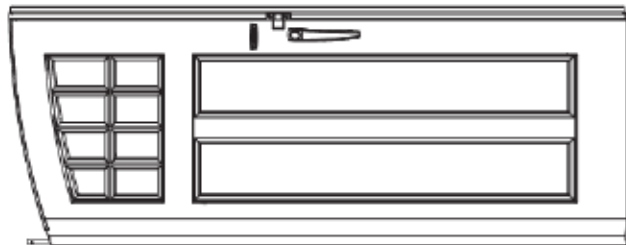

### TOOLS REQUIRED / INSTRUMENTAL REQUERIDO / OUTILS REQUIS



## ► SECTION 9 (CONTINUED) / SECCIÓN 9 (CONTINUACIÓN) / SECTION 9 (SUITE)

TOOLS AND HARDWARE REQUIRED / INSTRUMENTAL Y HERRAJE REQUERIDO / OUTILS ET QUINCAILLERIE REQUIS



AHP (x1)



• If you have trouble with this section, follow the code below to view a video on how to install the Doors.

• Si tiene problemas con esta sección, siga el código debajo para ver un video sobre la instalación de las Puertas.

• Si vous avez des problèmes avec cette section, suivez le code en bas pour voir un vidéo sur l'installation des Portes.



<http://go.lifetime.com/8-panedoorinstall>

### 9.1



• Pull the Hinge Tube down out of the Door about six inches. Align the hole at the bottom of the Hinge Tube with the slit in the Bushing, and insert the Tube. Insert a **Cotter Pin (AHP)** and bend the ends.

• Extienda el Tubo de articulación unos quince centímetros del borde inferior de la Puerta. Alinee el agujero en la parte inferior del Tubo con la rendija en el Casquillo, e inserte el Tubo. Inserte una **Clavija (AHP)** y doble los extremos.

• Éteignez le Tube d'articulation à peu près quinze centimètres du bord inférieur de la Porte. Alignez le trou dans la partie inférieure du Tube avec la fente dans la Bague, et insérez le Tube. Insérez une **Clavette (AHP)** et pliez les extrémités.

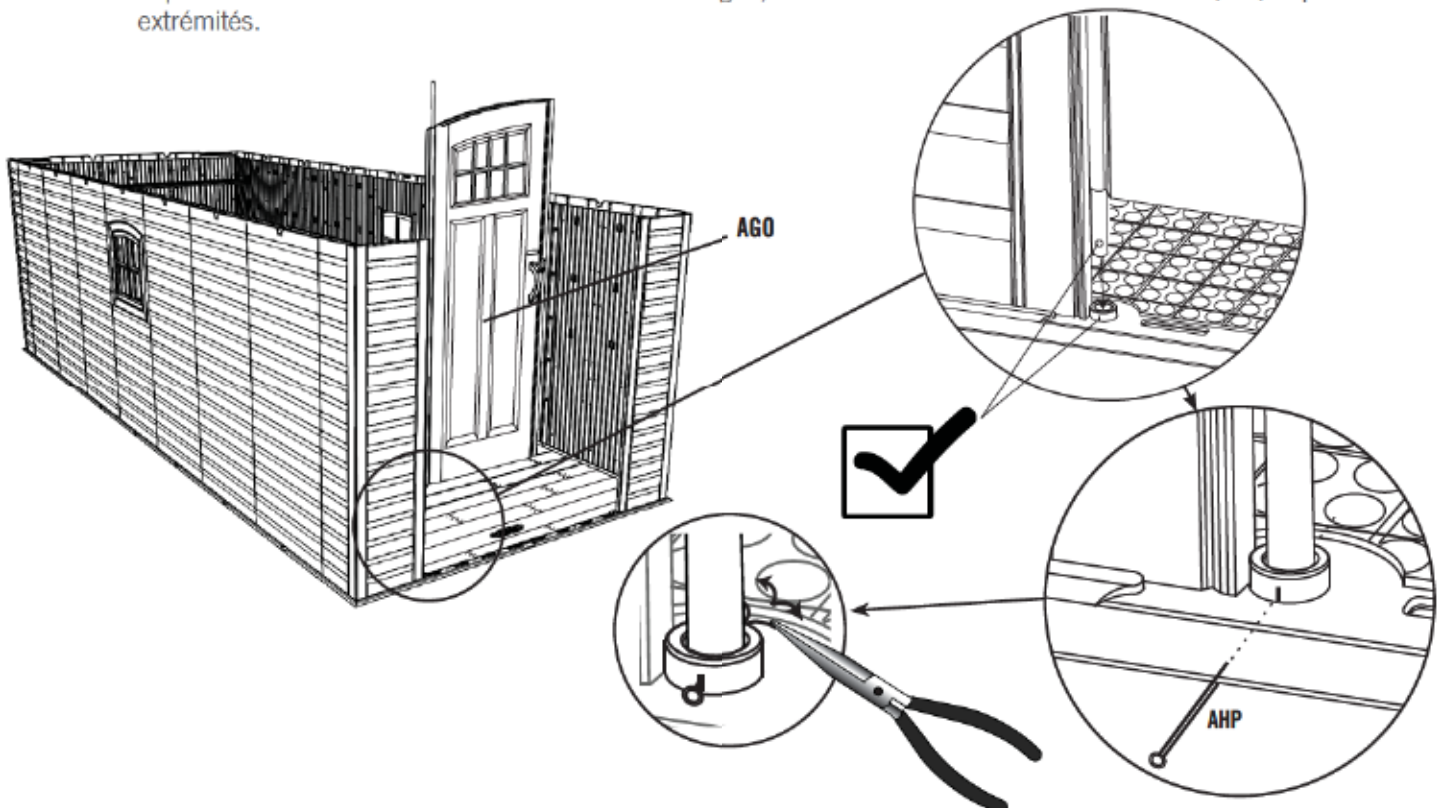

## ► SECTION 9 (CONTINUED) / SECCIÓN 9 (CONTINUACIÓN) / SECTION 9 (SUITE)

TOOLS AND HARDWARE REQUIRED / INSTRUMENTAL Y HERRAJE REQUERIDO / OUTILS ET QUINCAILLERIE REQUIS

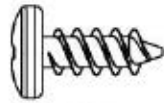

ADZ (x6)



AHP (x1)

### 9.2

- Repeat the previous step for the Right Door.
- Repita el paso anterior para la Puerta derecha.
- Répétez l'étape précédente pour la Porte droite.

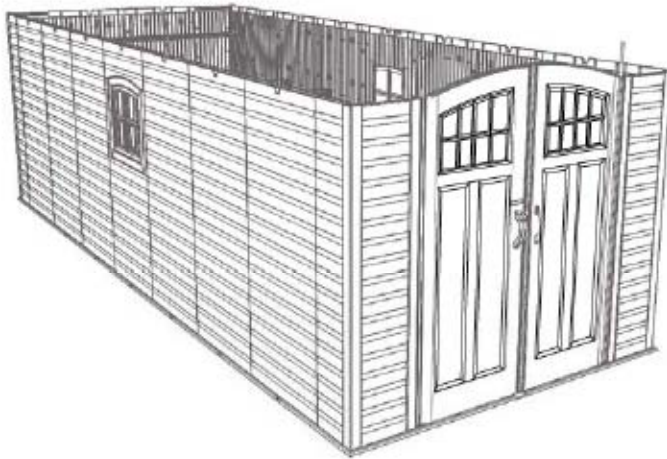

### 9.3

- Slide the holes in the Entry Gable down over the two Hinge Tubes.
- Deslice los agujeros en la Fachada de entrada sobre los dos Tubos.
- Glissez les trous dans le Toit à pignon d'entrée sur les deux Tubes.

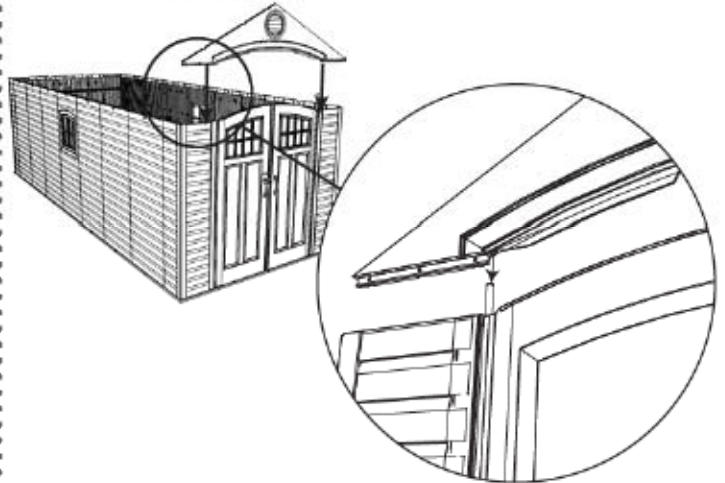

### 9.4

- Secure the Entry Gable to the shed using six (6) Screws (ADZ).
- Sujete la Fachada de entrada a la caseta usando seis (6) Tornillos (ADZ).
- Attachez le Toit à pignon d'entrée à l'abri à l'aide de six (6) Vis (ADZ).

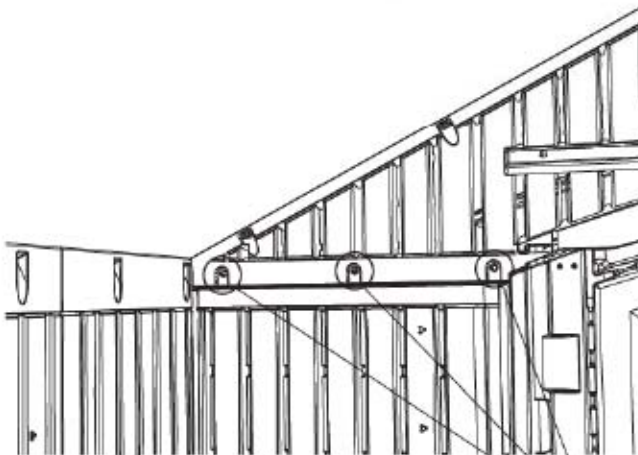

ADZ

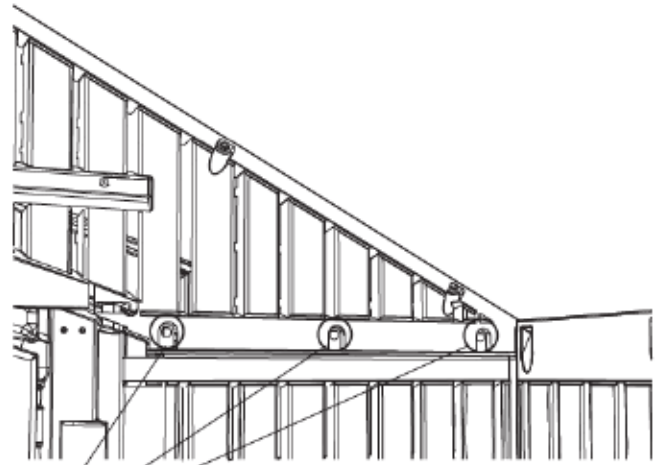

ADZ

## ► SECTION 9 (CONTINUED) / SECCIÓN 9 (CONTINUACIÓN) / SECTION 9 (SUITE)

TOOLS AND HARDWARE REQUIRED / INSTRUMENTAL Y HERRAJE REQUERIDO / OUTILS ET QUINCAILLERIE REQUIS



ADX (x4)

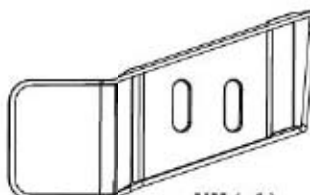

AIM (x1)



AIC (x1)

### 9.5

- Attach the **Left (AIC) and Right (AIM) Gap Flaps** to the corners of the Doors using the hardware provided. **These Flaps simply serve to block out light.**
- Sujete las **Tapas de las puertas izquierda (AIC) y derecha (AIM)** a las Puertas usando los accesorios incluidos. **Estas Tapas sirven sólo para tapan la luz.**
- Attachez les **Rabats gauche (AIC) et droit (AIM)** aux Portes à l'aide de la quincaillerie incluse. **Ces Rabats ne servent que pour empêcher la lumière d'entrer.**

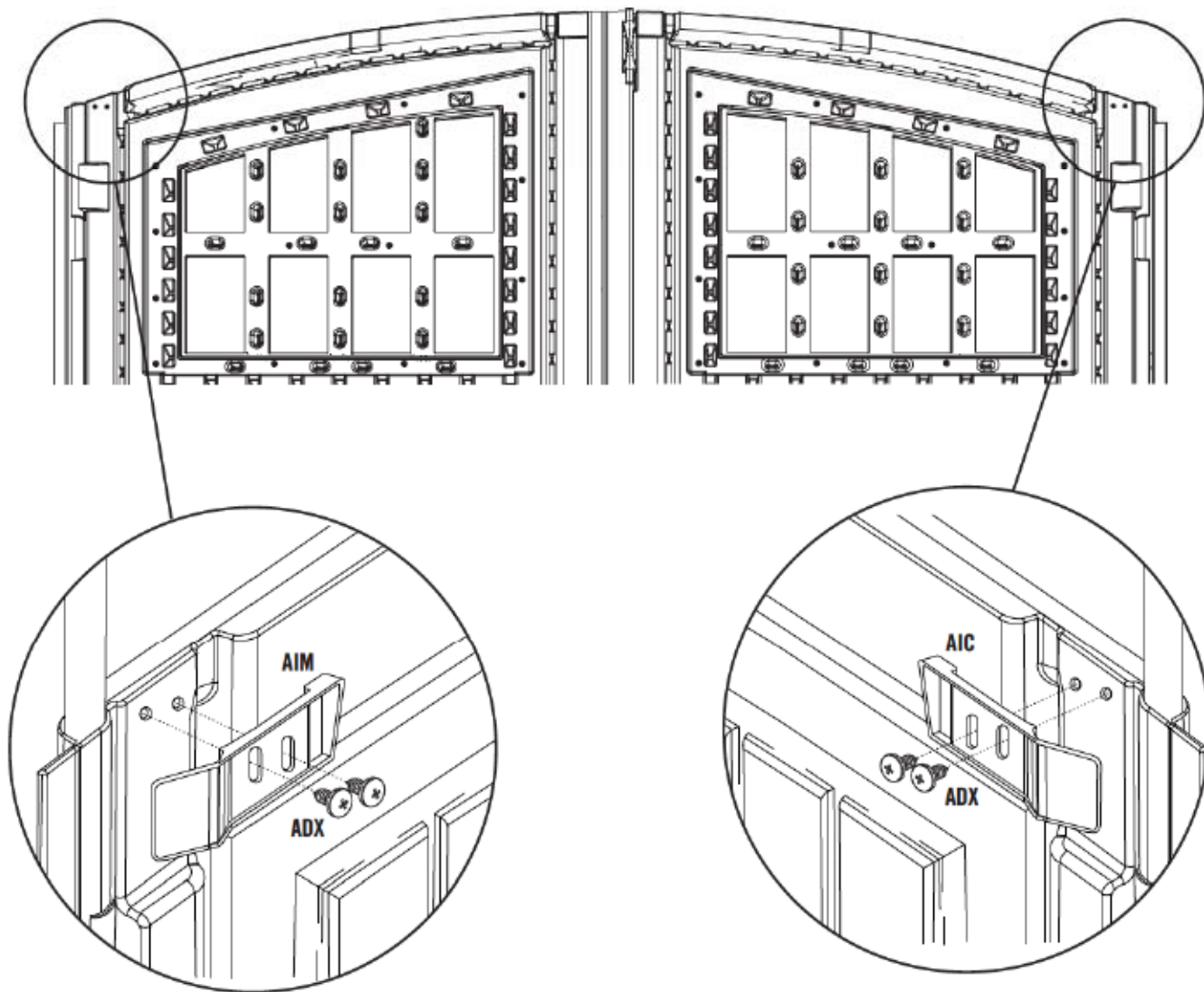



# PARTS IDENTIFIER / IDENTIFICADOR DE PIEZAS / IDENTIFICATEUR DE PIÈCES

CONTENTS OF BOX 1 / CONTENIDO DE LA CAJA 1 / CONTENU DE LA BOÎTE 1

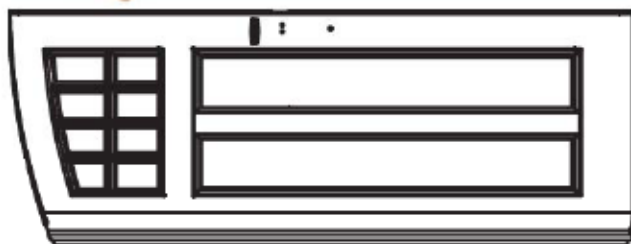

AGO (x1)

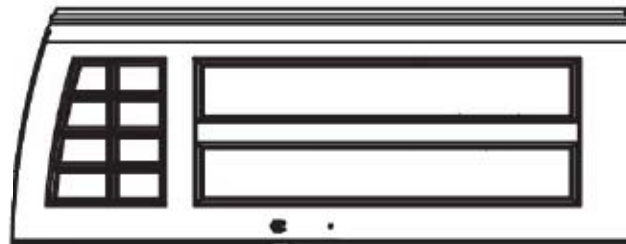

AGZ (x1)



AGF (x1)

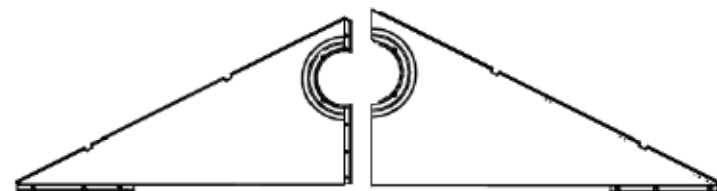

AGH (x1)

AGI (x1)

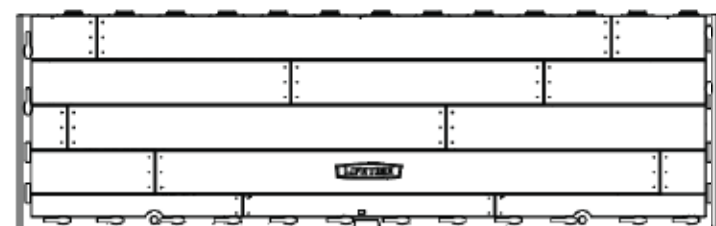

CUW (x2)

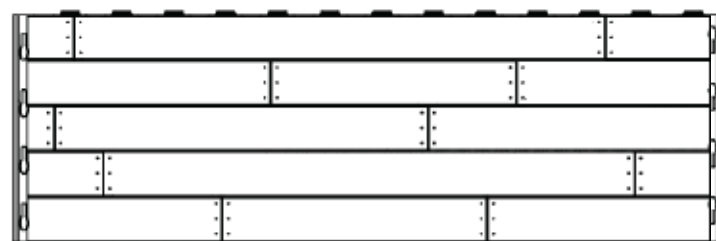

CUD (x2)



CVG (x4)



AFV (x1)

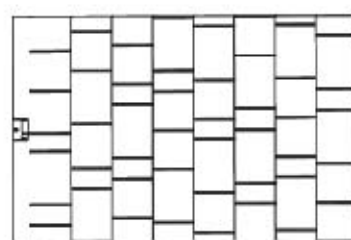

AGQ (x8)



CVA (x2)



45 1/2" (1,16 m)

CVC (x2)



45 1/2" (1,16 m)

CVE (x2)

Remove This Section / Retire Esta Sección / Enlevez Cette Section



# PARTS IDENTIFIER / IDENTIFICADOR DE PIEZAS / IDENTIFICATEUR DE PIÈCES

CONTENTS METAL KIT 1 / CONTENIDO DEL KIT DE PIEZAS DE METAL 1 / CONTENU DU KIT DE PIÈCES EN MÉTAL 1

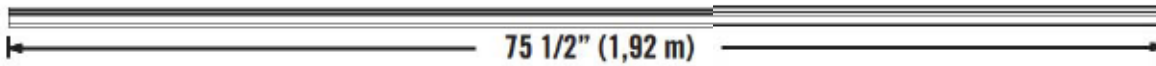

AFG (x2)

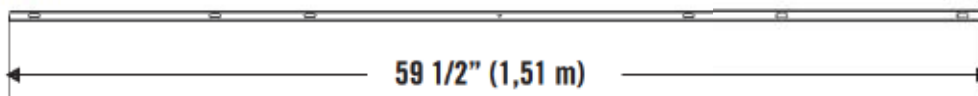

AFE (x1)

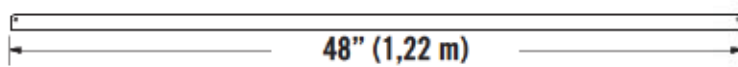
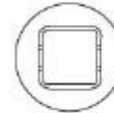

AFG (x3)

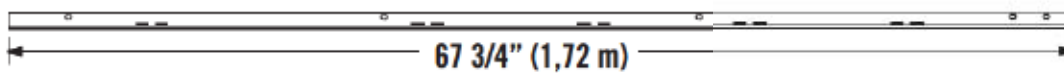

AFM (x2)

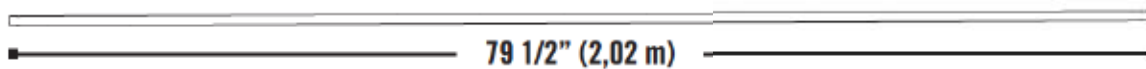

CRD (x2)

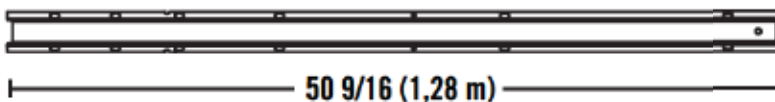

DSR (x3)



Remove This Section / Retire Esta Sección / Enlevez Cette Section

CONTENTS OF BOX 2 / CONTENIDO DE LA CAJA 2 / CONTENU DE LA BOÎTE 2

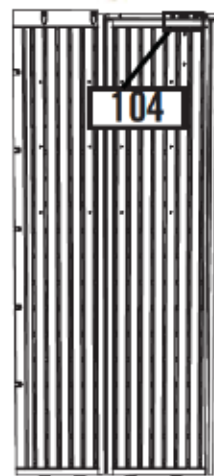

AGY (x1)

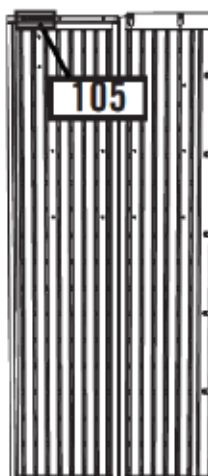

AGN (x1)

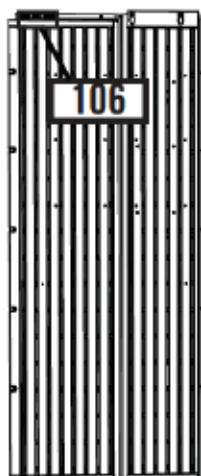

AGW (x1)

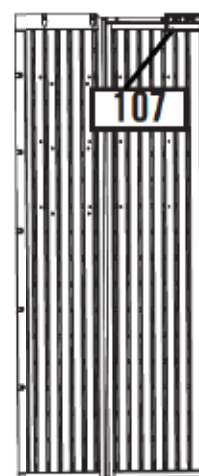

AGL (x1)



AHD (x7)



AHH (x1)





# PARTS IDENTIFIER / IDENTIFICADOR DE PIEZAS / IDENTIFICATEUR DE PIÈCES

CONTENTS SMALL PARTS BOX 1 / CONTENIDO DE LA CAJA DE PIEZAS PEQUEÑAS 1 / CONTENU DE LA BOÎTE DE PIÈCES EN MÉTAL 1



Parts / Piezas / Pièces

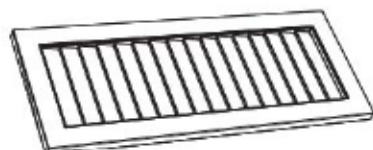

AYI (x2)



AFZ (x4)

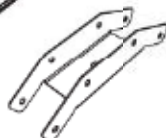

AIP (x7)

Wood Parts / Piezas de madera / Pièces en bois



AIW (x1)



AIX (x4)

Hardware Bags / Bolsas de herraje / Sacs de quincaillerie



Metal Parts / Piezas de metal / Pièces en métal

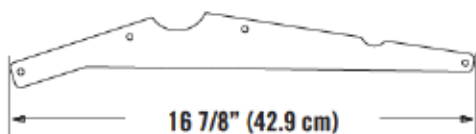

BQW (x28)

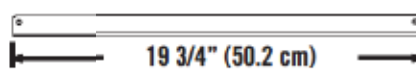

BRD (x7)

Hardware Bags / Bolsas de herraje / Sacs de quincaillerie

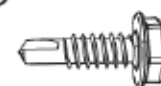

BRK (x140)

CONTENTS OF BOX 3 / CONTENIDO DE LA CAJA 3 / CONTENU DE LA BOÎTE 3

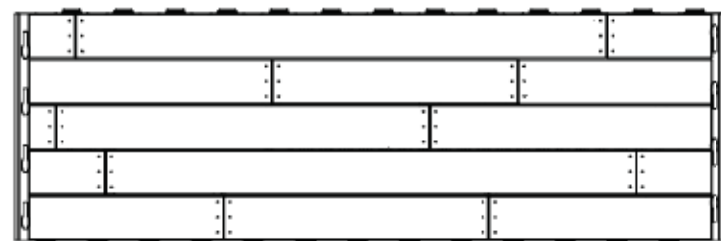

CUD (x4)

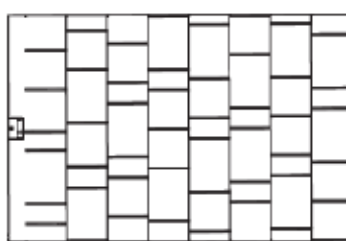

AGQ (x8)



DQB (x4)

Remove This Section / Retire Esta Sección / Enlevez Cette Section



# PARTS IDENTIFIER / IDENTIFICADOR DE PIEZAS / IDENTIFICATEUR DE PIÈCES

CONTENTS METAL KIT 2 / CONTENIDO DEL KIT DE PIEZAS DE METAL 2 / CONTENU DU KIT DE PIÈCES EN MÉTAL 2

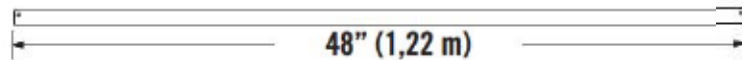

AFG (x4)

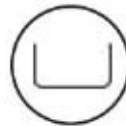

DSR (x5)



CONTENTS METAL KIT 3 / CONTENIDO DEL KIT DE PIEZAS DE METAL 3 / CONTENU DU KIT DE PIÈCES EN MÉTAL 3



DSR (x6)



CONTENTS OF BOX 4 / CONTENIDO DE LA CAJA 4 / CONTENU DE LA BOÎTE 4

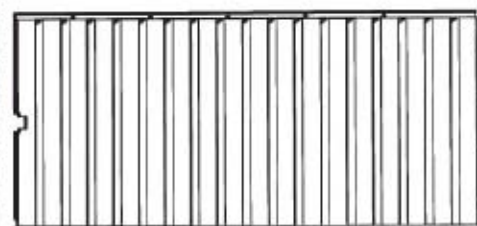

AHD (x7)

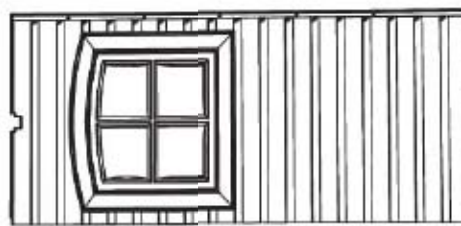

AHH (x1)

Remove This Section / Retire Esta Sección / Enlevez Cette Section

CONTENTS SMALL PARTS BOX 2 / CONTENIDO DE LA CAJA DE PIEZAS PEQUEÑAS 2 / CONTENU DE LA BOÎTE DE PIÈCES EN MÉTAL 2



AHE (x2)

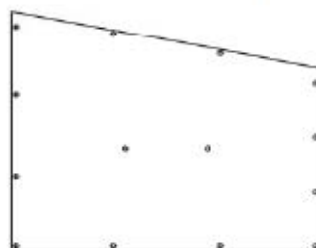

DHN (x2)



CVB (x2)

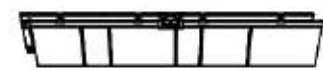

31" (0,79m)

CVD (x10)

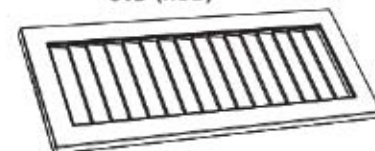

AYI (x2)



CVF (x5)

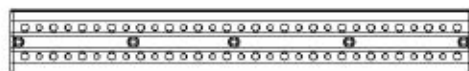

AFU (x2)



AFL (x16)



### HARDWARE REQUIRED / HERRAJE REQUERIDO / QUINCAILLERIE REQUISE

Hardware Bags / Bolsas de herraje / Sacs de quincaillerie

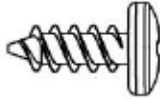

ADZ (x290)



CWU (x24)



CUZ (x4)

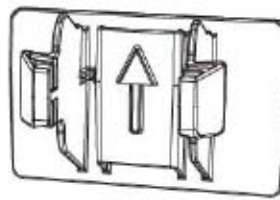

AXX (x2)

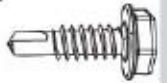

BRK (x84)



### PARTS REQUIRED / PIEZAS REQUERIDAS / PIÈCES REQUISES

Metal Parts / Piezas de metal / Pièces en métal



AFL (x16)



Plastic Parts / Piezas de plástico / Pièces en plastique

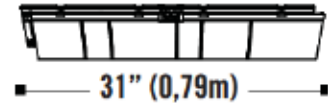

CVD (x10)

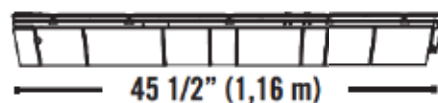

CVE (x2)

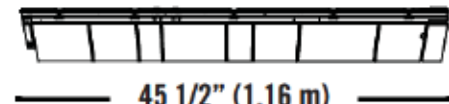

CVC (x2)



CVF (x5)

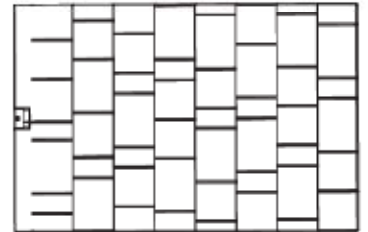

AGQ (x16)



CVG (x4)

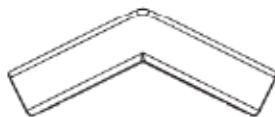

CVB (x2)



CVA (x2)

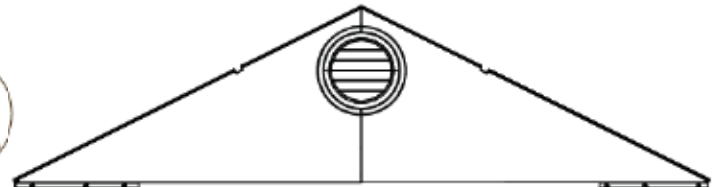

(x1)



DQB (x4)



### TOOLS REQUIRED / INSTRUMENTAL REQUERIDO / OUTILS REQUIS



3/8" (10 mm)

## ► SECTION 10 (CONTINUED) / SECCIÓN 10 (CONTINUACIÓN) / SECTION 10 (SUITE)

TOOLS AND HARDWARE REQUIRED / INSTRUMENTAL Y HERRAJE REQUERIDO / OUTILS ET QUINCAILLERIE REQUIS



- If you have trouble with this section, follow the code to the right to view a video on how to assemble the Roof.
- Si tiene problemas con esta sección, siga el código a la derecha para ver un video sobre el ensamble del Tejado.
- Si vous avez des problèmes avec cette section, suivez le code à droite pour voir un vidéo sur l'assemblage du Toit.



<http://go.lifetime.com/8x20snowroofassembly>

### 10.1

- You can make it easier to install the **Corner Trim (CVG)** pieces by flattening the spine along the length of the Trim before installation.
- Se puede facilitar la instalación de las **Molduras (CVG)** por aplanar el espino a lo largo de las piezas de Ribete antes de instalarlas.
- C'est plus facile installer les **Moulures (CVG)** par aplanir le dos le long des pièces avant de l'installation.

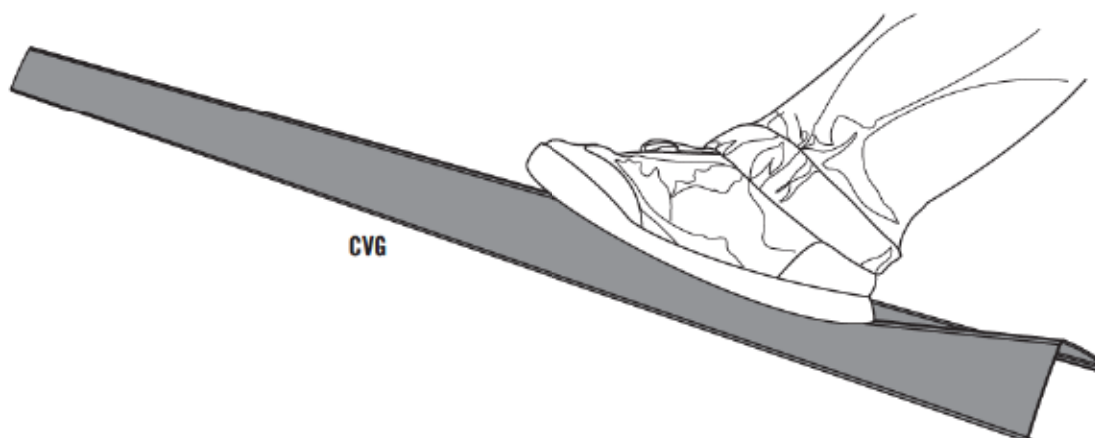

## ► SECTION 10 (CONTINUED) / SECCIÓN 10 (CONTINUACIÓN) / SECTION 10 (SUITE)

TOOLS AND HARDWARE REQUIRED / INSTRUMENTAL Y HERRAJE REQUERIDO / OUTILS ET QUINCAILLERIE REQUIS



CWU (x24)

### 10.2



- Attach a **Corner Trim (CVG)** to each corner with six (6) **Screws (CWU)**—two at the top, two in the middle, and two at the bottom. **Repeat for the other corners.**
- Sujete una **Moldura (CVG)** a cada esquina usando seis (6) **Tornillos (CWU)**: dos a la parte superior, dos en el centro, y dos a la parte inferior. **Repita para las otras esquinas.**
- Attachez une **Moulure (CVG)** à chaque coin à l'aide des six (6) **Vis (CWU)** — deux à la partie supérieure, deux dans le centre, et deux à la partie inférieure. **Répétez pour les autres coins.**

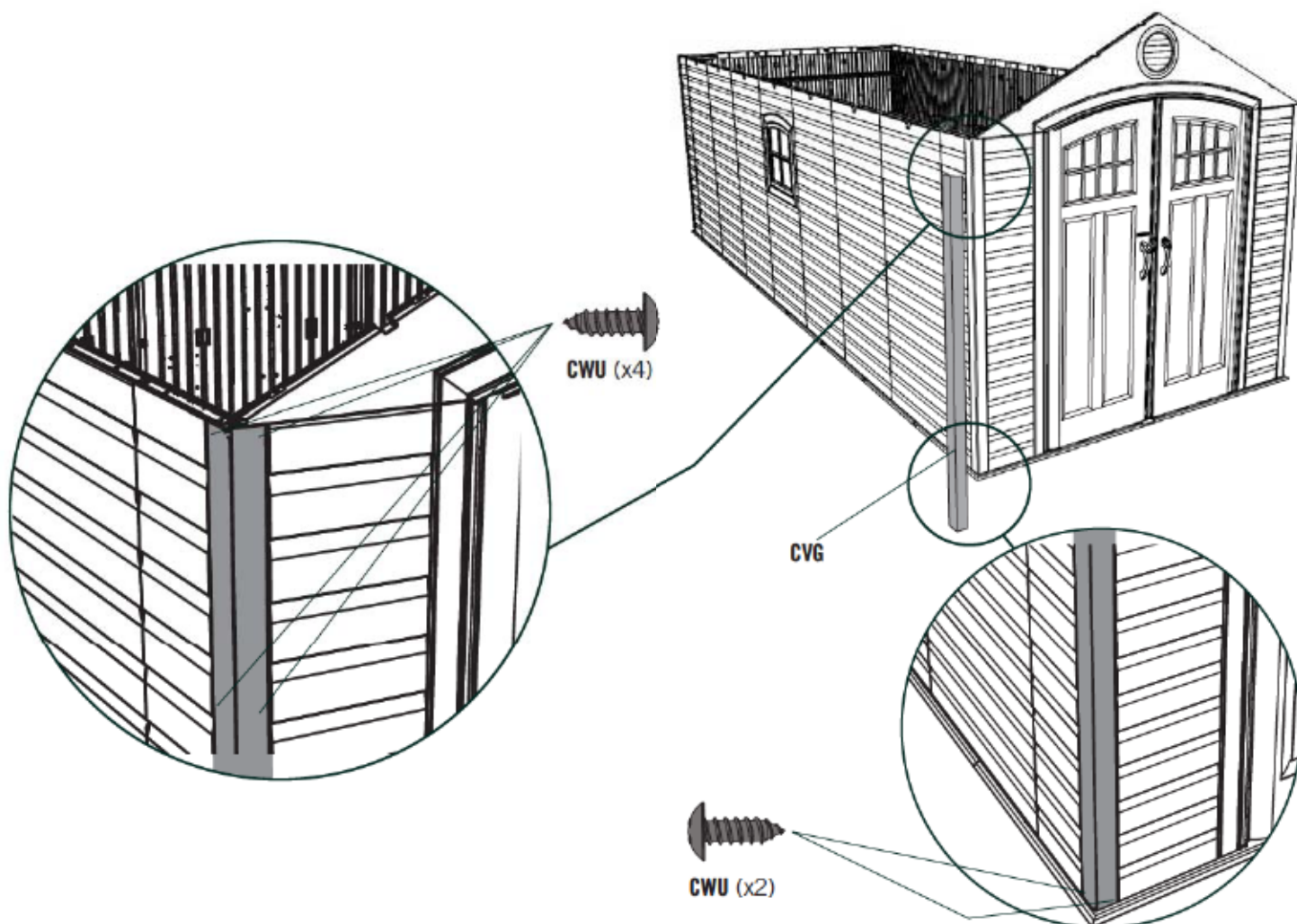

## ► SECTION 10 (CONTINUED) / SECCIÓN 10 (CONTINUACIÓN) / SECTION 10 (SUITE)

TOOLS AND HARDWARE REQUIRED / INSTRUMENTAL Y HERRAJE REQUERIDO / OUTILS ET QUINCAILLERIE REQUIS



### 10.3

- Set a Truss Assembly into the notches on the first two opposite Wall Panels. Set a **Roof Panel (AGQ)** onto the Gable, Wall Panel, and Truss Assembly.
- Coloque una Cercha dentro de las muescas de los primeros dos Paneles de pared opuestos. Coloque un **Panel de tejado (AGQ)** sobre la Fachada de entrada, Panel mural, y la Cercha.
- Mettez une Ferme dans les encoches des premiers deux Panneaux muraux opposés. Mettez un **Panneaux de toit (AGQ)** sur le Pignon, Panneau mural, et la Ferme.

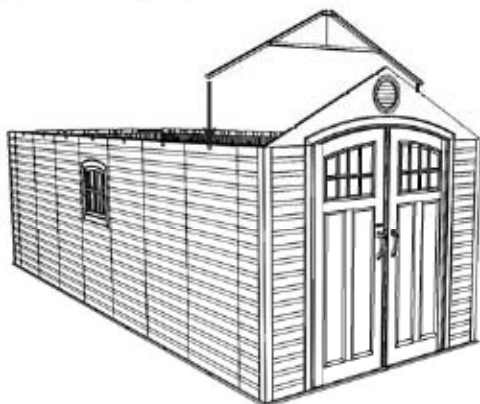

### 10.4

- Set the **Roof Panel (AGQ)** down onto the Wall Panel, Gable, and Truss. The groove at the bottom of the Roof Panel sets over the top of the Wall Panel. Ensure the alignment nub fits into the notch in the Truss.
- Coloque el **Panel de tejado (AGQ)** en el Panel de pared, la Fachada, y la Cercha. Coloque la ranura a lo largo del borde inferior del Panel de tejado sobre la parte superior del Panel de pared. Encaje el bulto de alineamiento en la muesca en la Cercha.
- Mettez le **Panneau de toit (AGQ)** dans le Panneau mural, le Pignon, et la Ferme. Mettez la rainure au bord inférieur du Panneau de toit sur la partie supérieure du Panneau mural. Mettez la petite bosse d'alignement dans l'encoche de la Ferme.

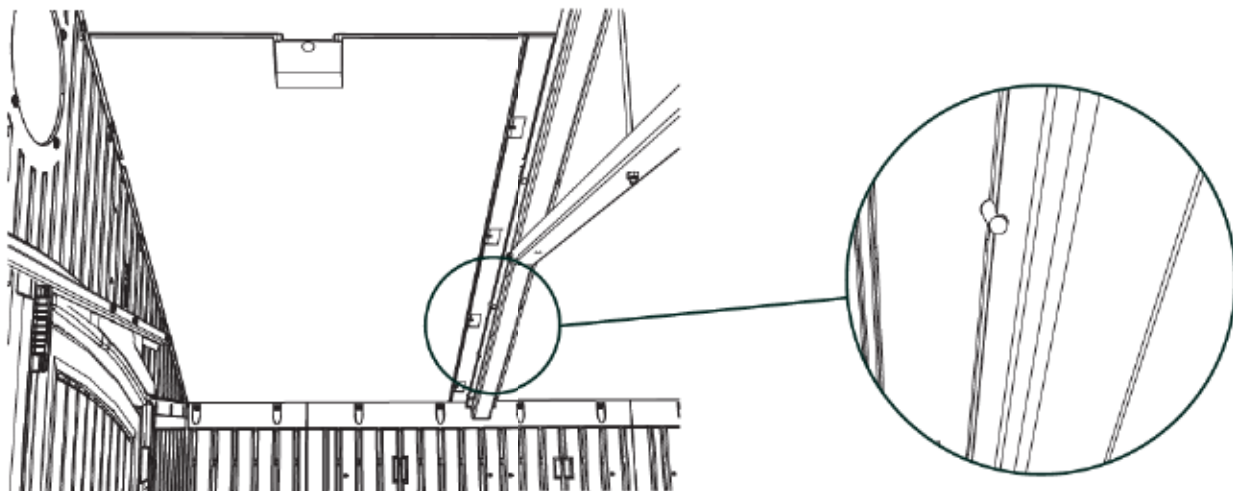

## ► SECTION 10 (CONTINUED) / SECCIÓN 10 (CONTINUACIÓN) / SECTION 10 (SUITE)

TOOLS AND HARDWARE REQUIRED / INSTRUMENTAL Y HERRAJE REQUERIDO / OUTILS ET QUINCAILLERIE REQUIS

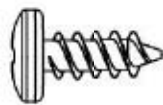

ADZ (x4)

### 10.5

- Align the four holes in the Wall Panel with those at the bottom of the Roof Panel, and insert four (4) **Screws (ADZ)** to secure the Panel in place.
- Alinee los cuatro agujeros en el Panel de pared con los al borde inferior del Panel de tejado, e introduzca cuatro (4) **Tornillos (ADZ)** para sujetarlo en su lugar.
- Alinez les quatre trous dans le Panneau mural avec ceux au bord inférieur du Panneau de toit, et insérez quatre (4) **Vis (ADZ)** pour attacher le Panneau en place.

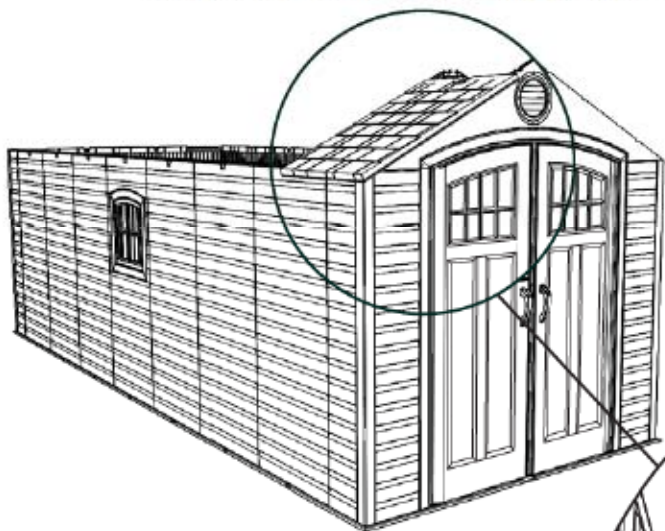

ADZ (x4)

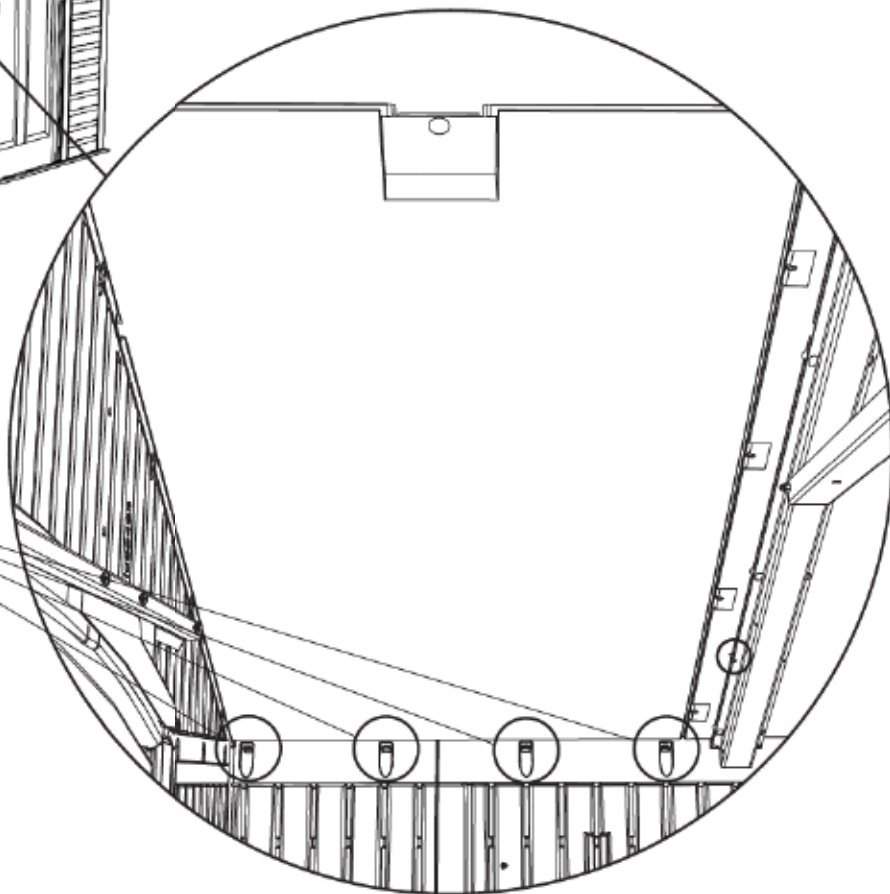

## ► SECTION 10 (CONTINUED) / SECCIÓN 10 (CONTINUACIÓN) / SECTION 10 (SUITE)

TOOLS AND HARDWARE REQUIRED / INSTRUMENTAL Y HERRAJE REQUERIDO / OUTILS ET QUINCAILLERIE REQUIS

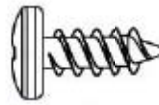

ADZ (x4)

### 10.6

- Insert the first two **Screws (ADZ)** through the Gable and into the Roof Panel and the first two **Screws (ADZ)** through the Truss and the Roof Panel at the locations shown.
- Introduzca los primeros dos **Tornillos (ADZ)** por la Fachada y dentro del Panel de tejado y los primeros dos **Tornillos (ADZ)** por el Armazón y dentro del Panel de tejado a las ubicaciones indicadas.
- Insérez les premières deux **Vis (ADZ)** à travers le Pignon et dans le Panneau de toit et les premières deux **Vis (ADZ)** à travers la Ferme et dans le Panneau de toit aux emplacements illustrés.

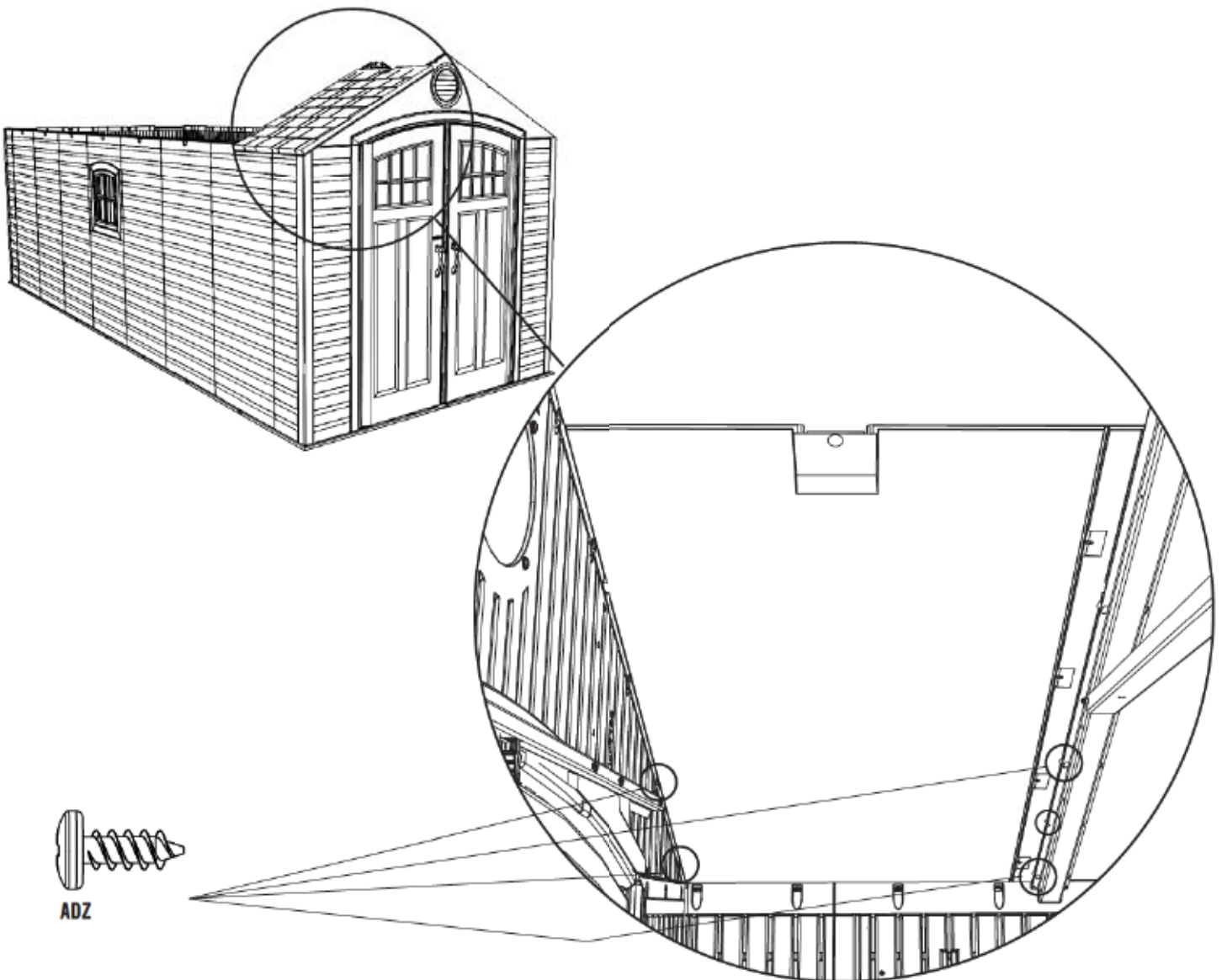



## ► SECTION 10 (CONTINUED) / SECCIÓN 10 (CONTINUACIÓN) / SECTION 10 (SUITE)

TOOLS AND HARDWARE REQUIRED / INSTRUMENTAL Y HERRAJE REQUERIDO / OUTILS ET QUINCAILLERIE REQUIS

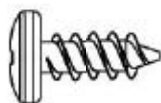

ADZ (x14)

### 10.7

- Insert the **Roof Support (AFL)** into the notches in the Gable and between the Truss and the Roof Panel. Insert three (3) more **Screws (ADZ)** to secure the Panel in place.
- Inserte el **Soporte de tejado (AFL)** en las muescas en la Fachada y entre la Cercha y el Panel de tejado. Introduzca tres (3) **Tornillos (ADZ)** más para sujetar el Panel en su lugar.
- Mettez le **Support de toit (AFL)** dans les encoches dans le Pignon et entre le Panneau de toit et la Ferme. Insérez trois (3) autres **Vis (ADZ)** pour attacher le Panneau en place.

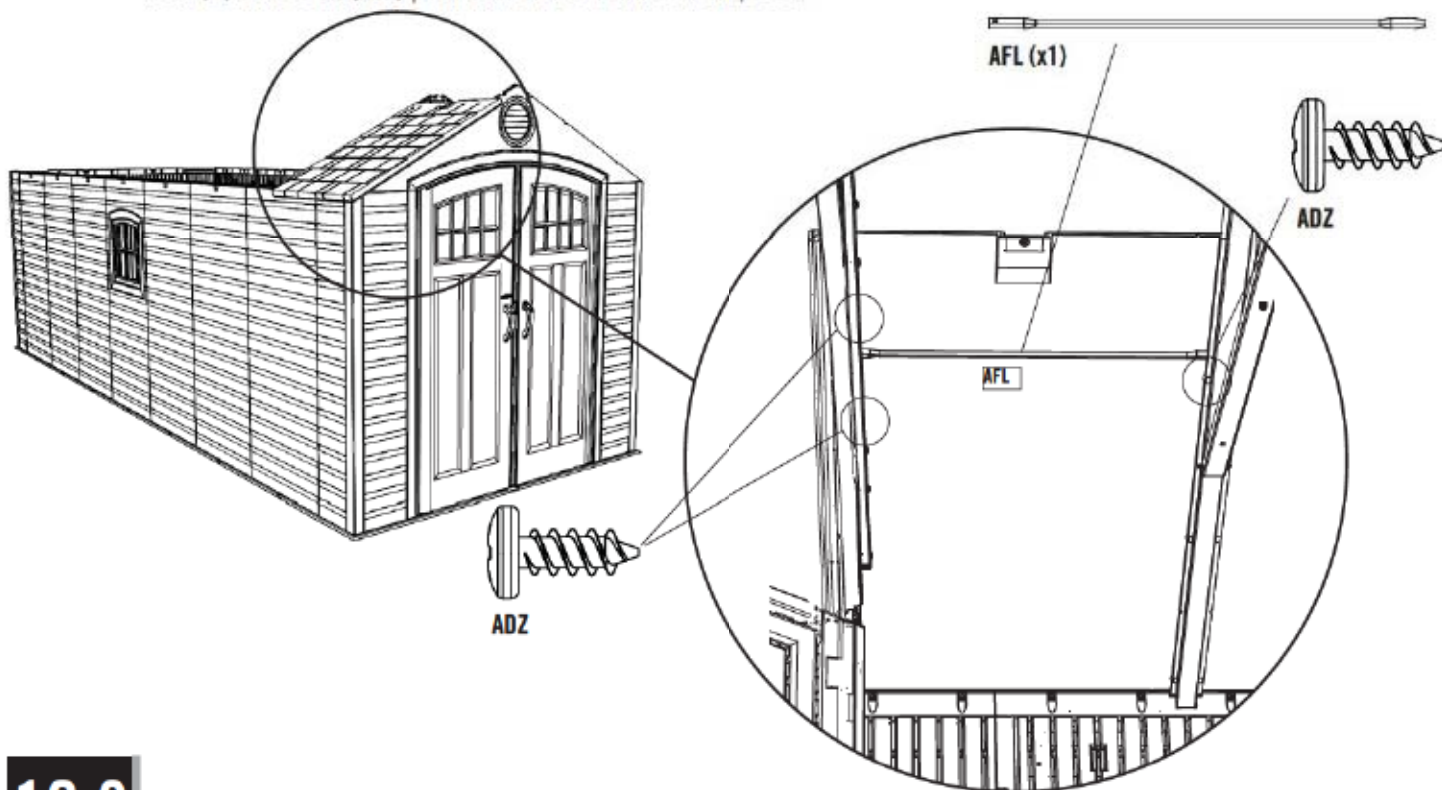

### 10.8

- Repeat steps 10.4–10.7 for the second front Roof Panel.
- Repita los pasos 10.4–10.7 para el segundo Panel de tejado delantero.
- Répétez les étapes 10.4 – 10.7 pour le deuxième Panneau de toit avant.



AFL (x1)



## ► SECTION 10 (CONTINUED) / SECCIÓN 10 (CONTINUACIÓN) / SECTION 10 (SUITE)

TOOLS AND HARDWARE REQUIRED / INSTRUMENTAL Y HERRAJE REQUERIDO / OUTILS ET QUINCAILLERIE REQUIS

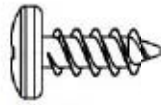

ADZ (x60)

### 10.9

- Repeat the previous steps for the center Roof Panels.
- Repita los pasos anteriores para los Paneles de tejado centrales.
- Répétez les étapes précédentes pour les Panneaux de toit centraux.



AFL (x6)

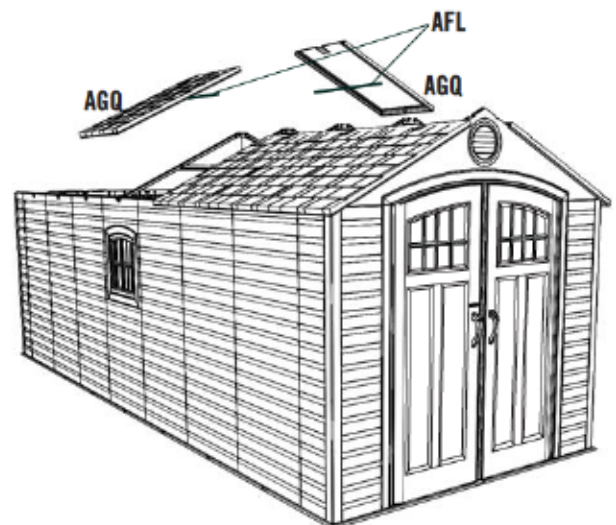
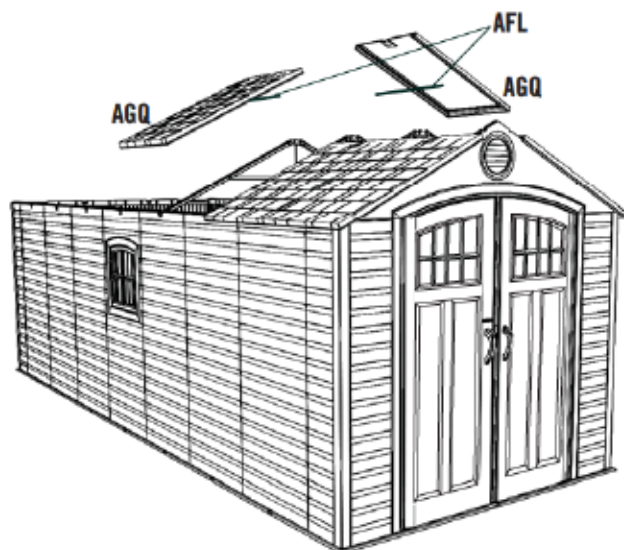
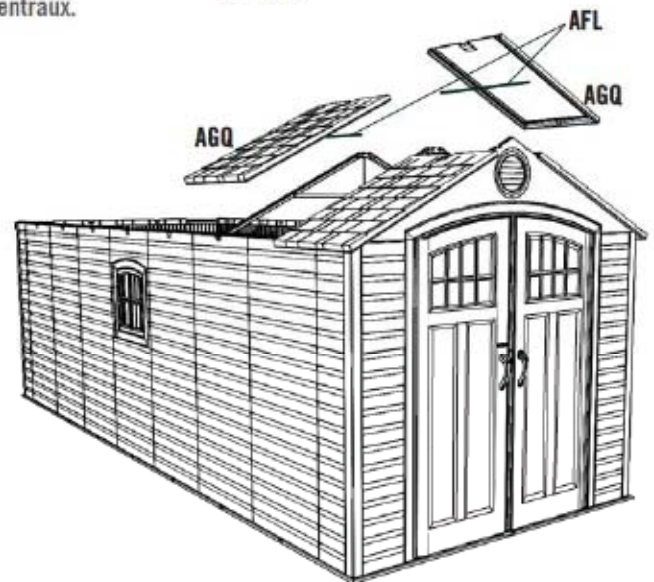
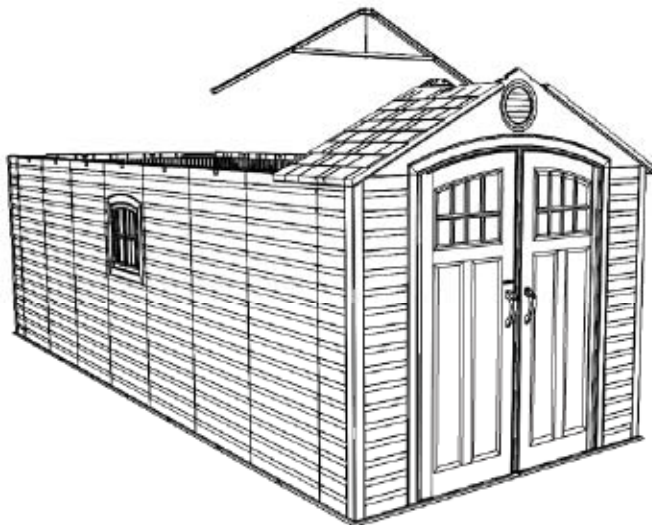

## ► SECTION 10 (CONTINUED) / SECCIÓN 10 (CONTINUACIÓN) / SECTION 10 (SUITE)

TOOLS AND HARDWARE REQUIRED / INSTRUMENTAL Y HERRAJE REQUERIDO / OUTILS ET QUINCAILLERIE REQUIS

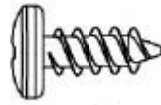

ADZ (x60)

### 10.10

- Continue repeating the previous steps for the center Roof Panels.
- Siga repitiendo los pasos anteriores para los Paneles de tejado centrales.
- Suivez répéter les étapes précédentes pour les Panneaux de toit centraux.

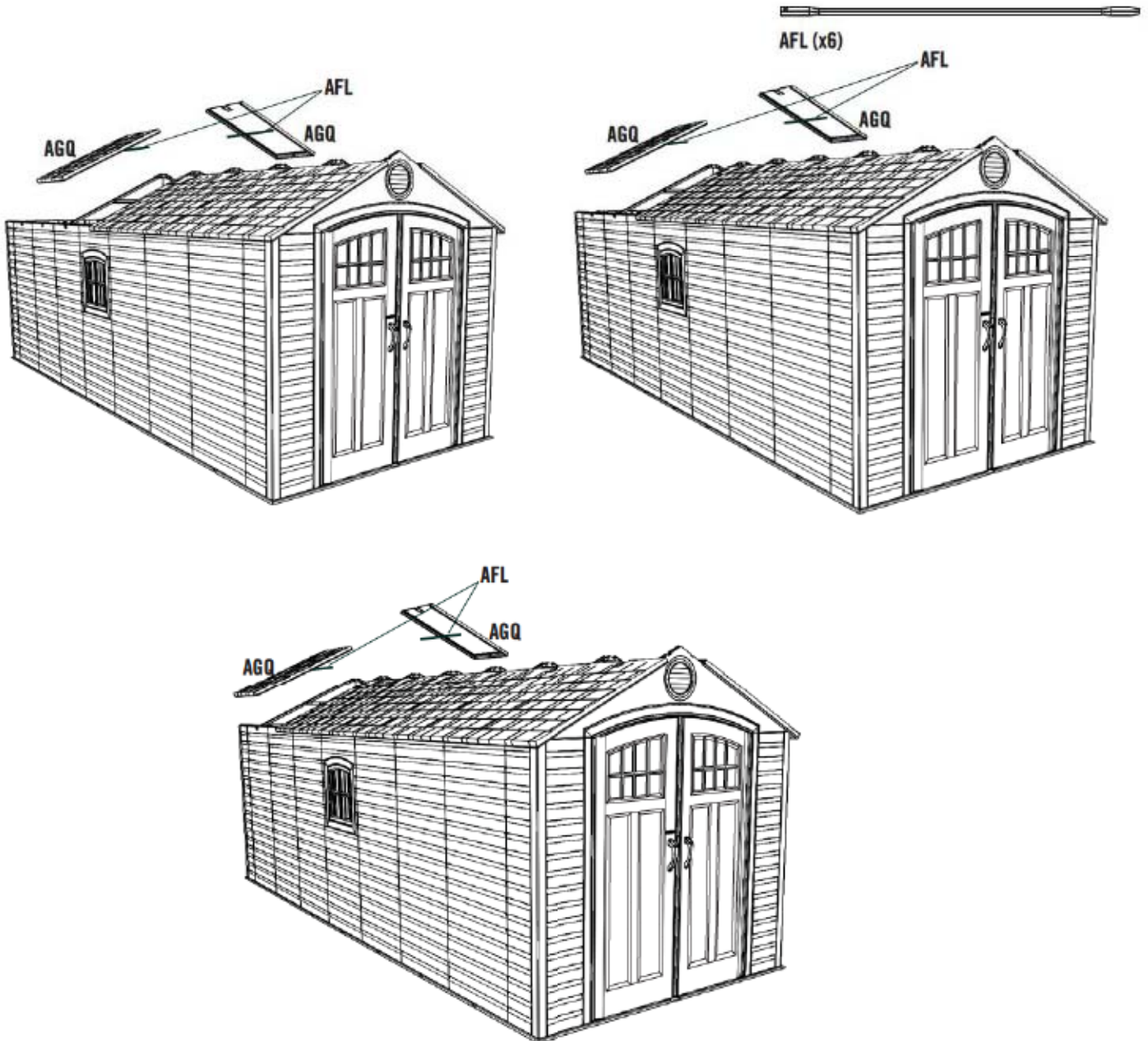

## ► SECTION 10 (CONTINUED) / SECCIÓN 10 (CONTINUACIÓN) / SECTION 10 (SUITE)

TOOLS AND HARDWARE REQUIRED / INSTRUMENTAL Y HERRAJE REQUERIDO / OUTILS ET QUINCAILLERIE REQUIS

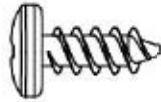

ADZ (x36)

### 10.11

- Attach the Rear Gable to the Shed using fourteen (14) Screws (ADZ).
- Sujete la Fachada trasera a la caseta usando catorce (14) Tornillos (ADZ).
- Attachez le Pignon arrière à l'abri à l'aide de quatorze (14) Vis (ADZ).

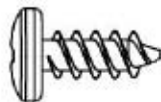
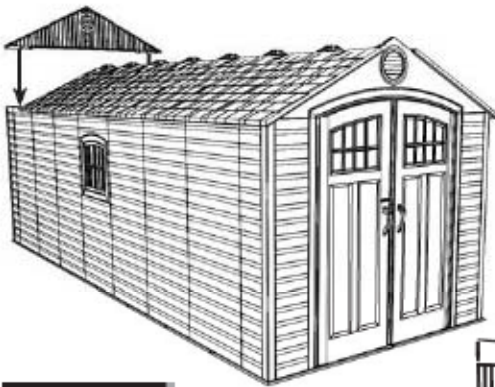

ADZ (x7)

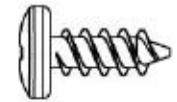

ADZ (x7)

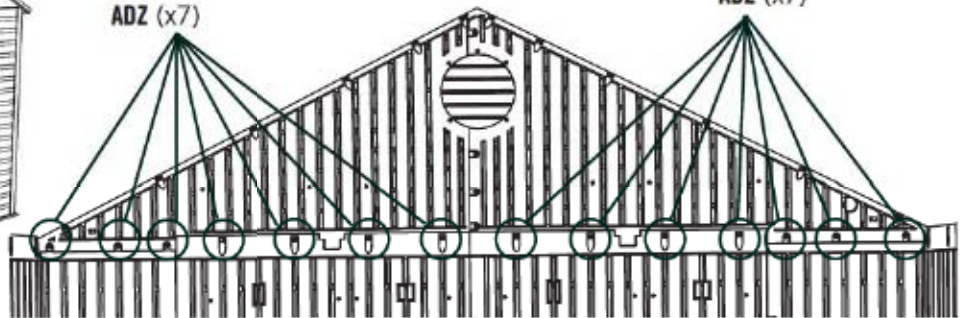

### 10.12

- Attach the last two Roof Panels to the Shed in the same way you did the first two.
- Sujete los últimos dos Paneles de tejado a la caseta en la misma manera que los primeros dos.
- Attachez les derniers deux Panneaux de toit à l'abri dans la même façon que les premiers deux.

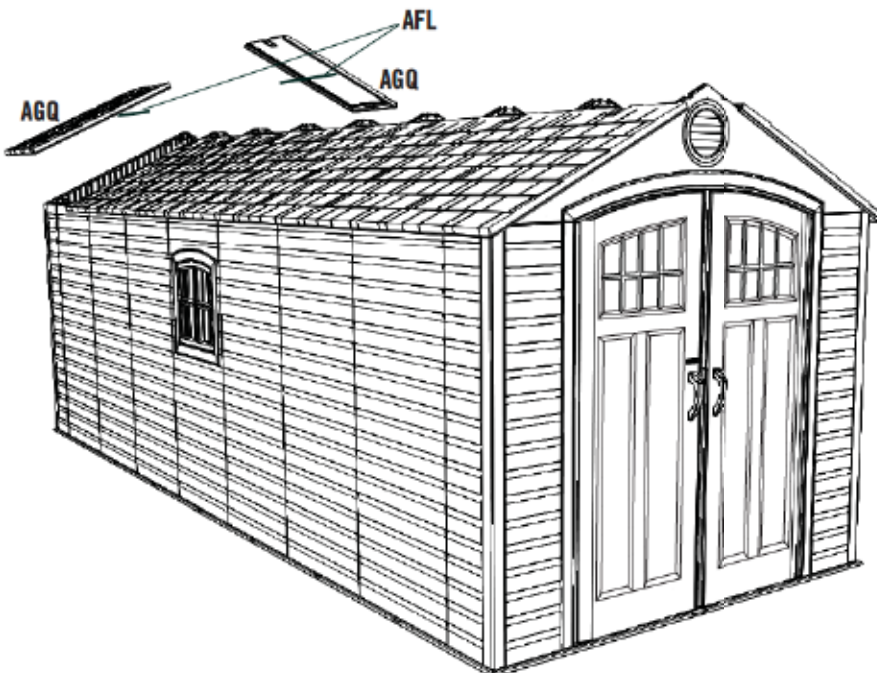

AFL (x2)

## ► SECTION 10 (CONTINUED) / SECCIÓN 10 (CONTINUACIÓN) / SECTION 10 (SUITE)

TOOLS AND HARDWARE REQUIRED / INSTRUMENTAL Y HERRAJE REQUERIDO / OUTILS ET QUINCAILLERIE REQUIS



### 10.13

- Insert the two **Center Roof Extension Panels (CVD)** into the **Skylight Connector (CVF)** as shown. Repeat this step 4 times (for a total of five).
- Inserte los dos **Extensiones centrales de los paneles de tejado (CVD)** en el **Conector de tragaluces (CVF)** como se muestra. Repita este paso 4 veces (cinco veces en total).
- Insérez les deux **Panneaux supplémentaires centraux de toit (CVD)** dans le **Connecteur des lucarnes (CVF)** como ilustré. Répétez cette étape 4 fois (cinq fois au total).

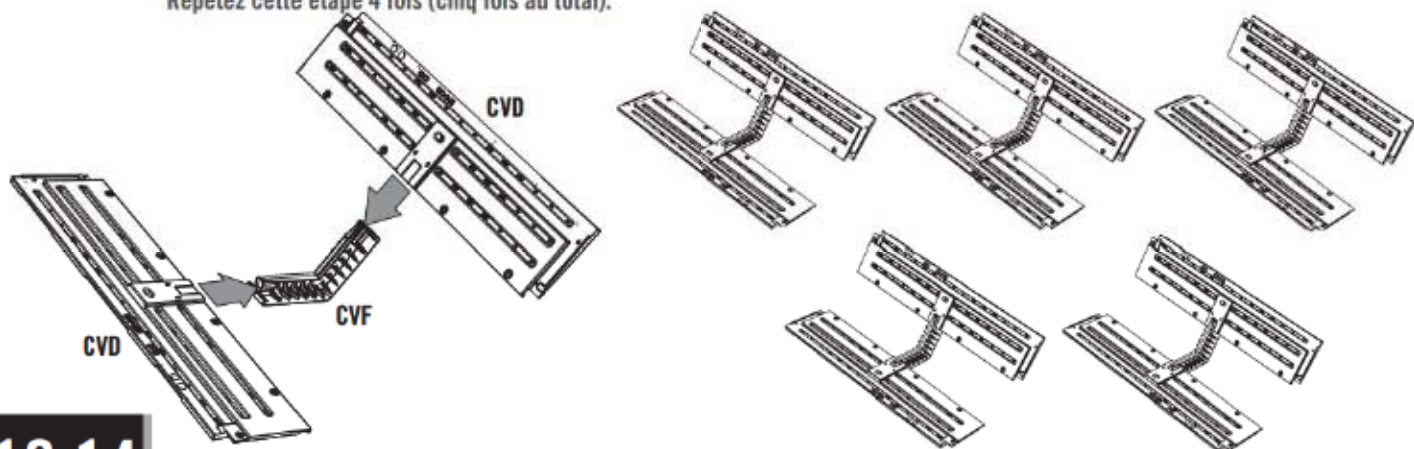

### 10.14

- Insert the ends of the two **Short Skylights (DQB)** into one Skylight Connector as shown.
- Inserte los extremos de los dos **Tragaluces cortos (DQB)** en un Conector de tragaluces como se muestra.
- Insérez les extrémités des deux **Lucarnes courtes (DQB)** dans un Connecteur des lucarnes como ilustré.

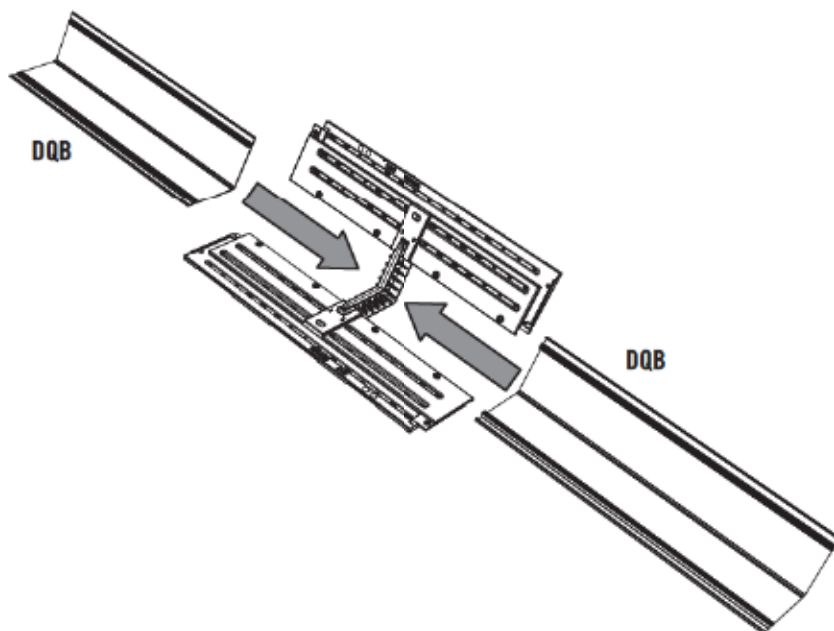

## ► SECTION 10 (CONTINUED) / SECCIÓN 10 (CONTINUACIÓN) / SECTION 10 (SUITE)

TOOLS AND HARDWARE REQUIRED / INSTRUMENTAL Y HERRAJE REQUERIDO / OUTILS ET QUINCAILLERIE REQUIS

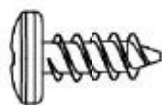

ADZ (x8)

### 10.15

- Secure the Skylights to the Extensions at the four points shown.
- Sujete los Tragaluces a las Extensiones a los cuatro puntos indicados.
- Attachez les Lucarnes aux Panneaux supplémentaires aux quatre points indiqués.

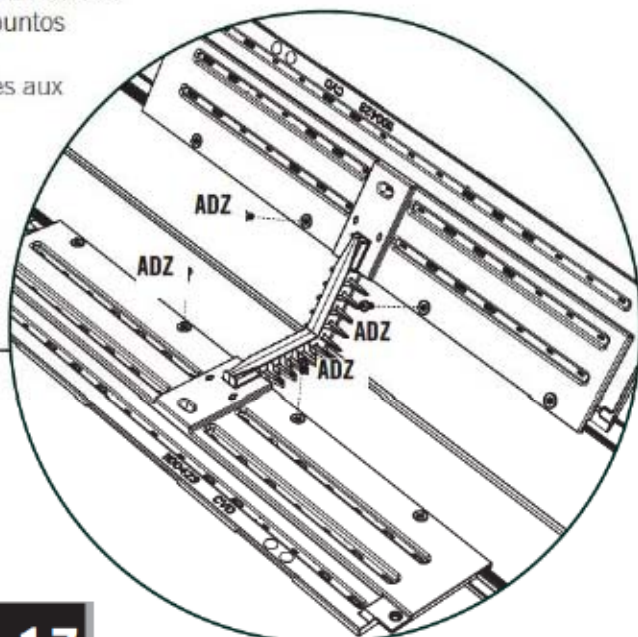
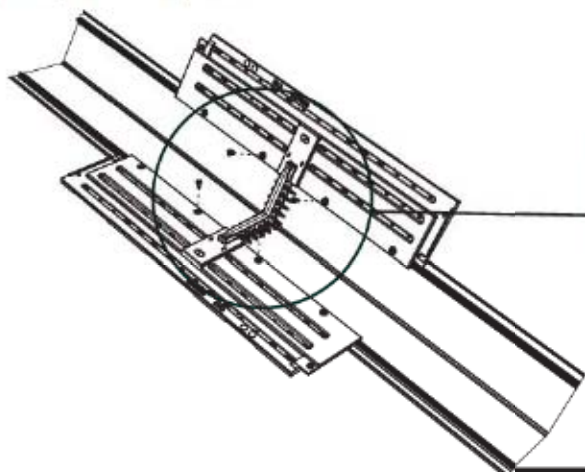

### 10.16

- Insert the end of the one **Short Skylight (DQB)** into the Skylight Connector as shown.
- Inserte el extremo de un **Tragaluz corto (DQB)** en el Conector de tragaluces como se muestra.
- Insérez l'extrémité d'une **Lucarne courte (DQB)** dans le Connecteur des lucarnes comme illustré.

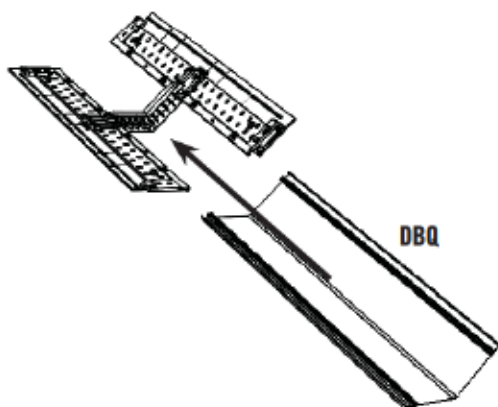

### 10.17

- Repeat the last step and secure the Skylights using two (2) Screws (ADZ) as shown.
- Repita el paso anterior y sujete los Tragaluces usando dos (2) Tornillos (ADZ) como se muestra.
- Répétez l'étape précédente et attachez les Lucarnes à l'aide de deux (2) Vis (ADZ) comme illustré.

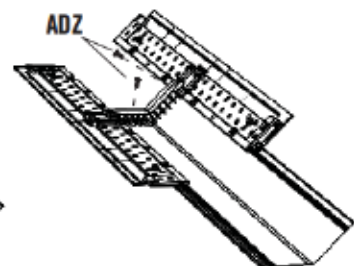
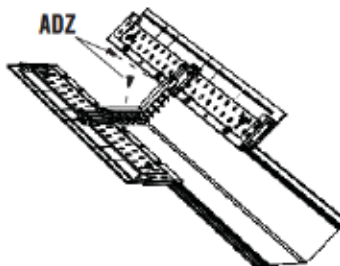

## ► SECTION 10 (CONTINUED) / SECCIÓN 10 (CONTINUACIÓN) / SECTION 10 (SUITE)

TOOLS AND HARDWARE REQUIRED / INSTRUMENTAL Y HERRAJE REQUERIDO / OUTILS ET QUINCAILLERIE REQUIS

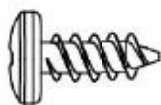

ADZ (x12)

### 10.18

- Slide the two Skylight Assemblies from steps 10.16–10.17 to the Connector and Extensions from steps 10.14–10.15.
- Deslice los dos Conjuntos de tragaluces de los pasos 10.16–10.17 al Conector y las Extensiones de los pasos 10.14–10.15.
- Glissez les deux Montages des lucarnes des étapes 10.16 – 10.17 au Connecteur et aux Panneaux supplémentaires des étapes 10.14 – 10.15.

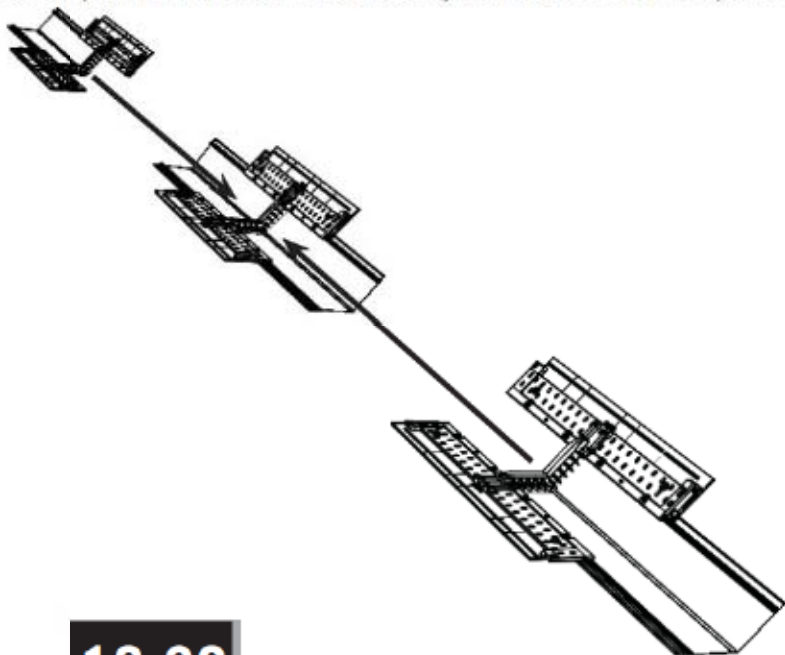

### 10.19

- Secure with six (6) Screws (ADZ).
- Sujételos con seis (6) Tornillos (ADZ).
- Attachez-les à l'aide de six (6) Vis (ADZ).

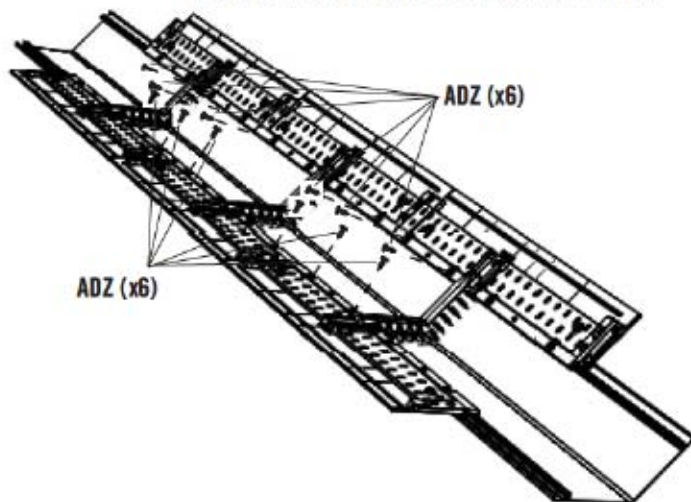

### 10.20

- Slide the last two Assemblies from step 10.13 over the ends of the Skylights.
- Deslice los últimos dos Conjuntos del paso 10.13 sobre los extremos de los Tragaluces.
- Glissez les derniers deux Montages de l'étape 10.13 sur les extrémités des Lucarnes.

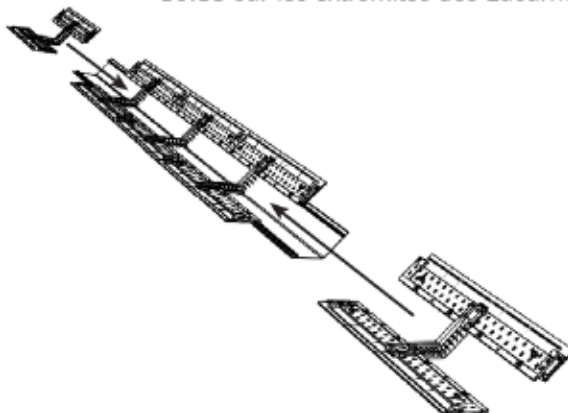

## ► SECTION 10 (CONTINUED) / SECCIÓN 10 (CONTINUACIÓN) / SECTION 10 (SUITE)

TOOLS AND HARDWARE REQUIRED / INSTRUMENTAL Y HERRAJE REQUERIDO / OUTILS ET QUINCAILLERIE REQUIS

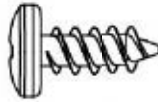

ADZ (x12)

### 10.21

- Secure the Skylight to the Panels using four (4) **Screws (ADZ)** at the locations shown.
- Sujete el Tragaluz a los Paneles usando cuatro (4) **Tornillos (ADZ)** a las ubicaciones indicadas.
- Attachez la Lucarne aux Panneaux à l'aide de quatre (4) **Vis (ADZ)** aux emplacements indiqués.

- *Repeat this step for the other end.*
- *Repita este paso para el otro extremo.*
- *Répétez cette étape pour l'autre extrémité.*

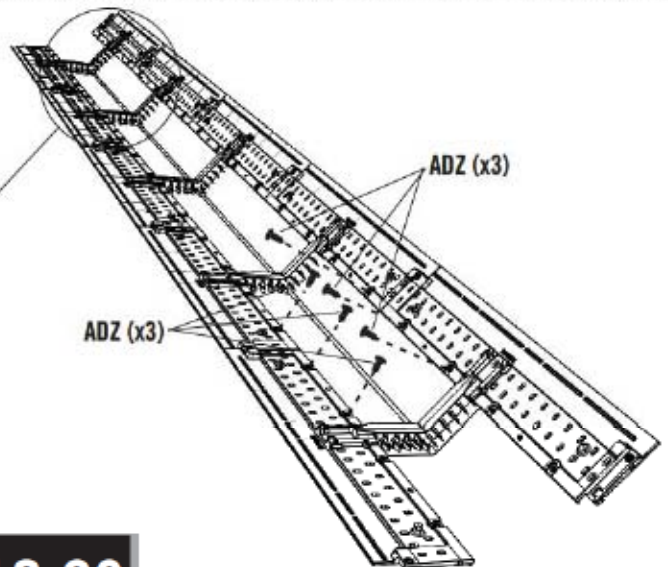

### 10.22

- Slide the two **Long Skylights (CVA)** into the Assembly.
- Deslice los dos **Tragaluces largos (CVA)** en el Conjunto.
- Glissez les deux **Lucarnes longues (CVA)** dans le Montage.

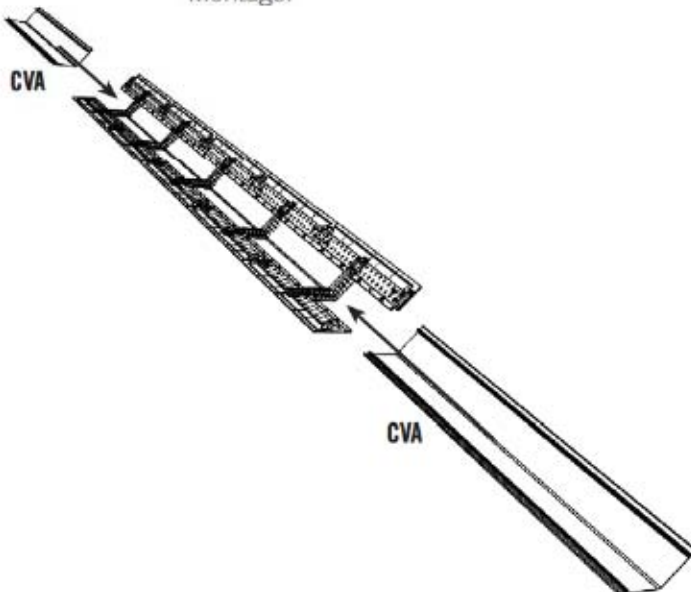

### 10.23

- Attach the **Long Roof Extensions (CVC & CVE)** to the Assembly.
- Sujete las **Extensiones de tejado largas (CVC & CVE)** al Conjunto.
- Attachez les **Panneaux de toit supplémentaires longs (CVC & CVE)** au Montage.

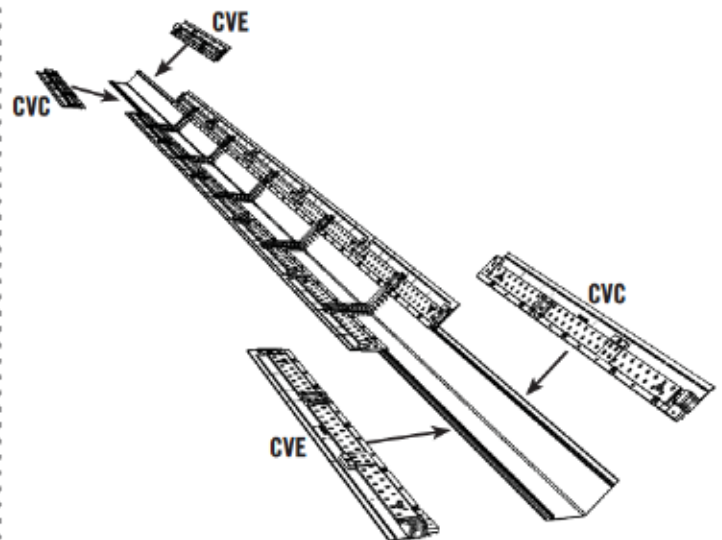



## ► SECTION 10 (CONTINUED) / SECCIÓN 10 (CONTINUACIÓN) / SECTION 10 (SUITE)

TOOLS AND HARDWARE REQUIRED / INSTRUMENTAL Y HERRAJE REQUERIDO / OUTILS ET QUINCAILLERIE REQUIS

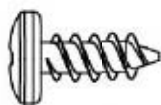

ADZ (x28)

### 10.24

- Secure the Long Roof Extensions to the Skylight Assembly using fourteen (14) **Screws (ADZ)**.
- Sujete las Extensiones del panel de tejado al Conjunto del tragaluz usando catorce (14) **Tornillos (ADZ)**.
- Attachez les Panneaux de toit supplémentaires au Montage de lucarne à l'aide de quatorze (14) **Vis (ADZ)**.

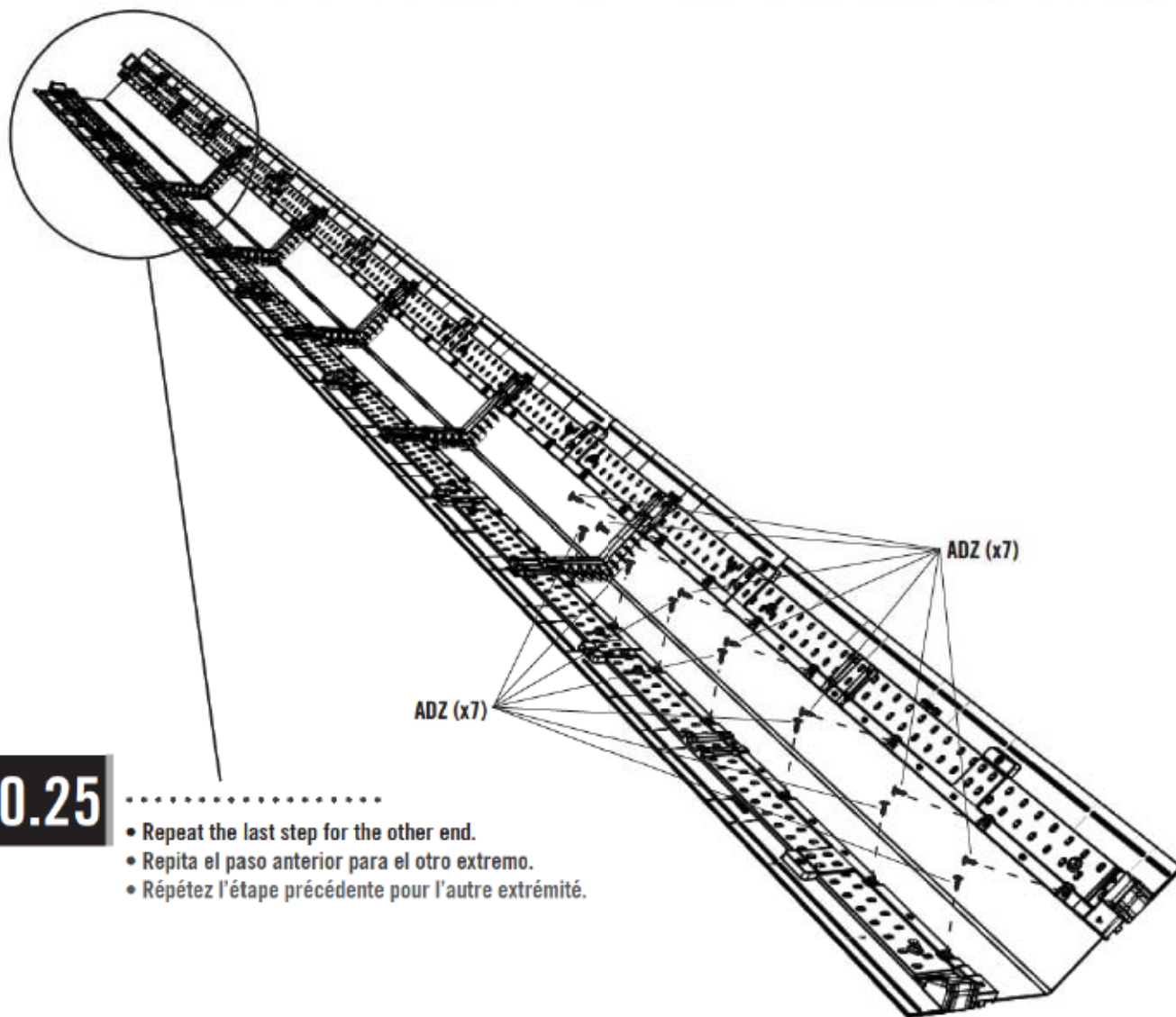

### 10.25

- Repeat the last step for the other end.
- Repita el paso anterior para el otro extremo.
- Répétez l'étape précédente pour l'autre extrémité.

## ► SECTION 10 (CONTINUED) / SECCIÓN 10 (CONTINUACIÓN) / SECTION 10 (SUITE)

TOOLS AND HARDWARE REQUIRED / INSTRUMENTAL Y HERRAJE REQUERIDO / OUTILS ET QUINCAILLERIE REQUIS

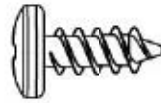

ADZ (x28)

### 10.26



- Set the five Skylight Connectors down inside the five center Trusses. **The center Skylight Connector should be inside the center Truss.** Secure the Skylight to the Trusses with four (4) **Screws (ADZ)** at the locations indicated for each Truss.
- Coloque los cinco Conectores de tragaluz dentro de las cinco Cerchas centrales. **El Conector de tragaluz central debe situarse dentro de la Cercha central.** Sujete los Tragaluces a las Cerchas usando cuatro (4) **Tornillos (ADZ)** a las ubicaciones indicadas para cada Cercha.
- Mettez les cinq Connecteurs des lucarnes dedans les cinq Fermes centraux. **Le Connecteur des lucarnes central doit être placé dans la Ferme centrale.** Attachez les Lucarnes aux Fermes à l'aide de quatre (4) **Vis (ADZ)** aux emplacements indiqués pour chaque Ferme.

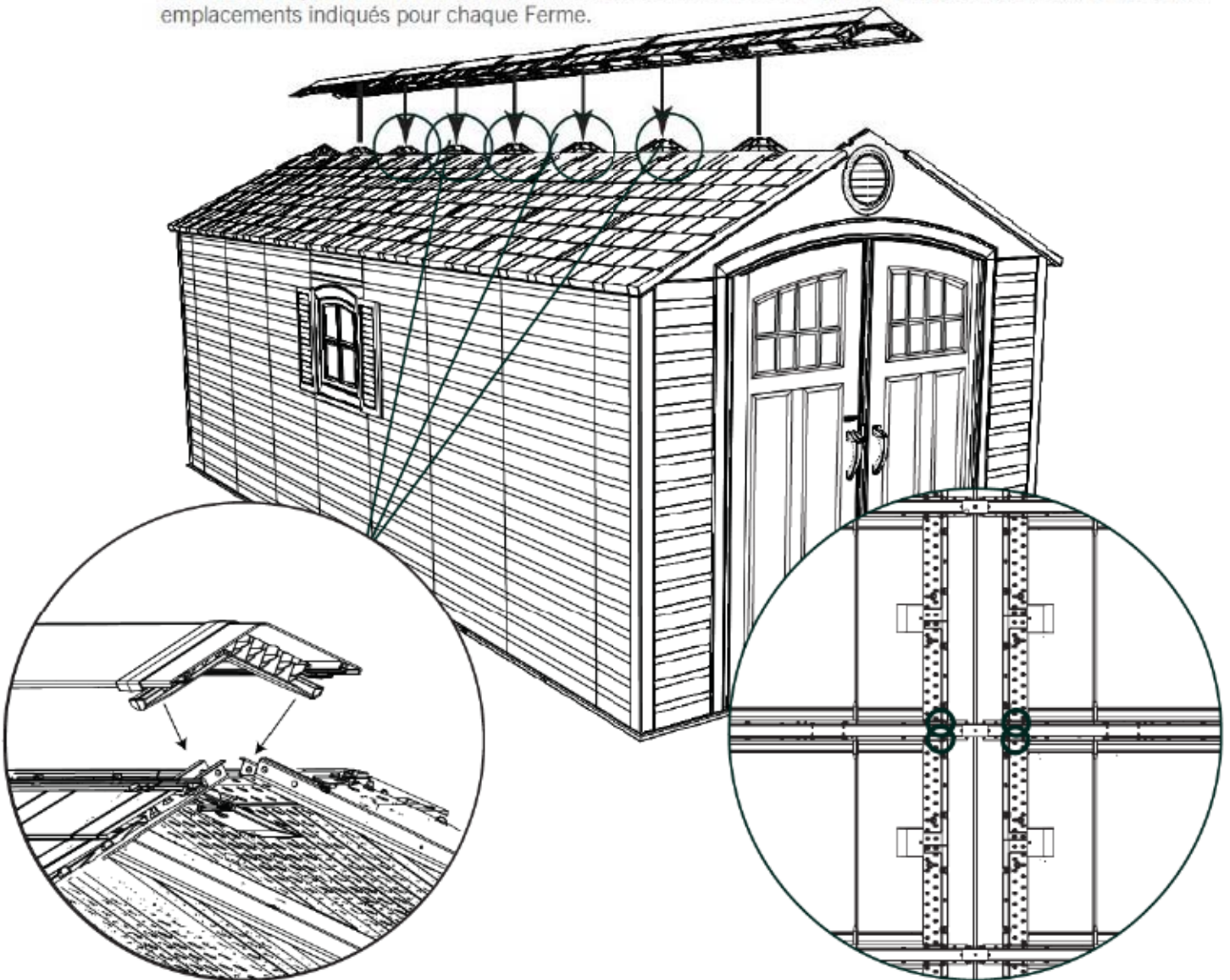

► SECTION 10 (CONTINUED) / SECCIÓN 10 (CONTINUACIÓN) / SECTION 10 (SUITE)

TOOLS AND HARDWARE REQUIRED / INSTRUMENTAL Y HERRAJE REQUERIDO / OUTILS ET QUINCAILLERIE REQUIS

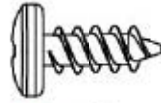

ADZ (x20)

10.27



- Connect the Roof Panel Extensions to the Roof Panels and Gables at the locations shown.
- Sujételas las Extensiones de los paneles de tejado a los Paneles de tejado y las Fachadas a las ubicaciones indicadas.
- Attachez les Panneaux de toit supplémentaires aux Panneaux de toit et aux Fermes aux emplacements indiqués.

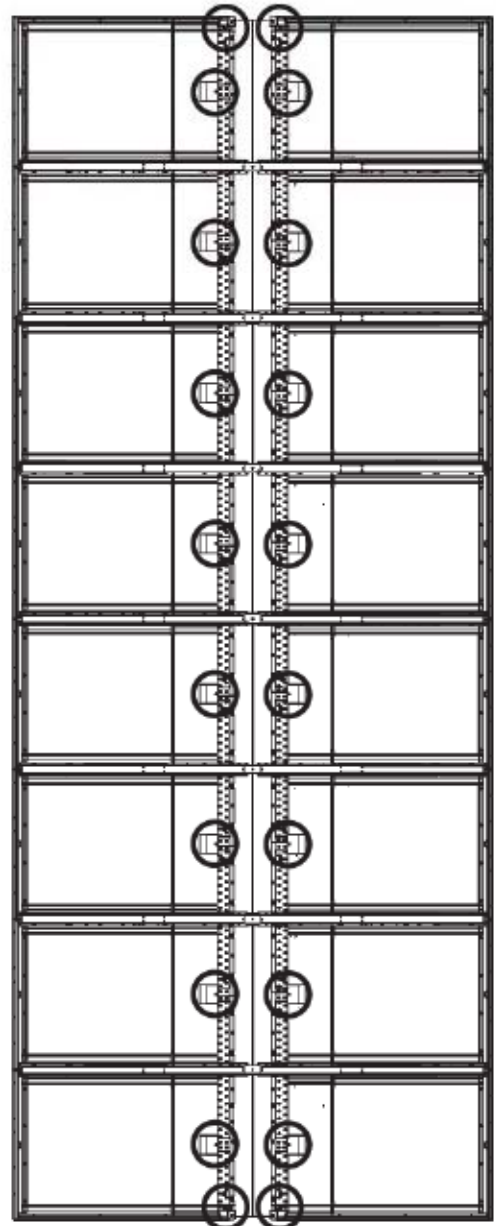
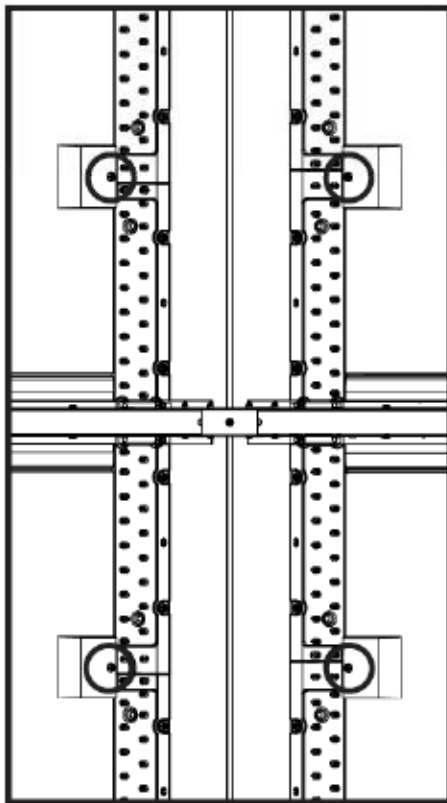

## ► SECTION 10 (CONTINUED) / SECCIÓN 10 (CONTINUACIÓN) / SECTION 10 (SUITE)

TOOLS AND HARDWARE REQUIRED / INSTRUMENTAL Y HERRAJE REQUERIDO / OUTILS ET QUINCAILLERIE REQUIS

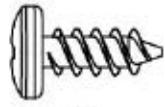

ADZ (x4)



CUZ (x4)

### 10.28

- Attach an **End Cap (CVB)** at each end, and secure at the locations shown.
- Coloque un **Tapón (CVB)** a cada extremo, y sujételos a las ubicaciones indicadas.
- Mettez un **Capuchon (CVB)** a chaque côté, et attachez-les aux emplacements illustrés.

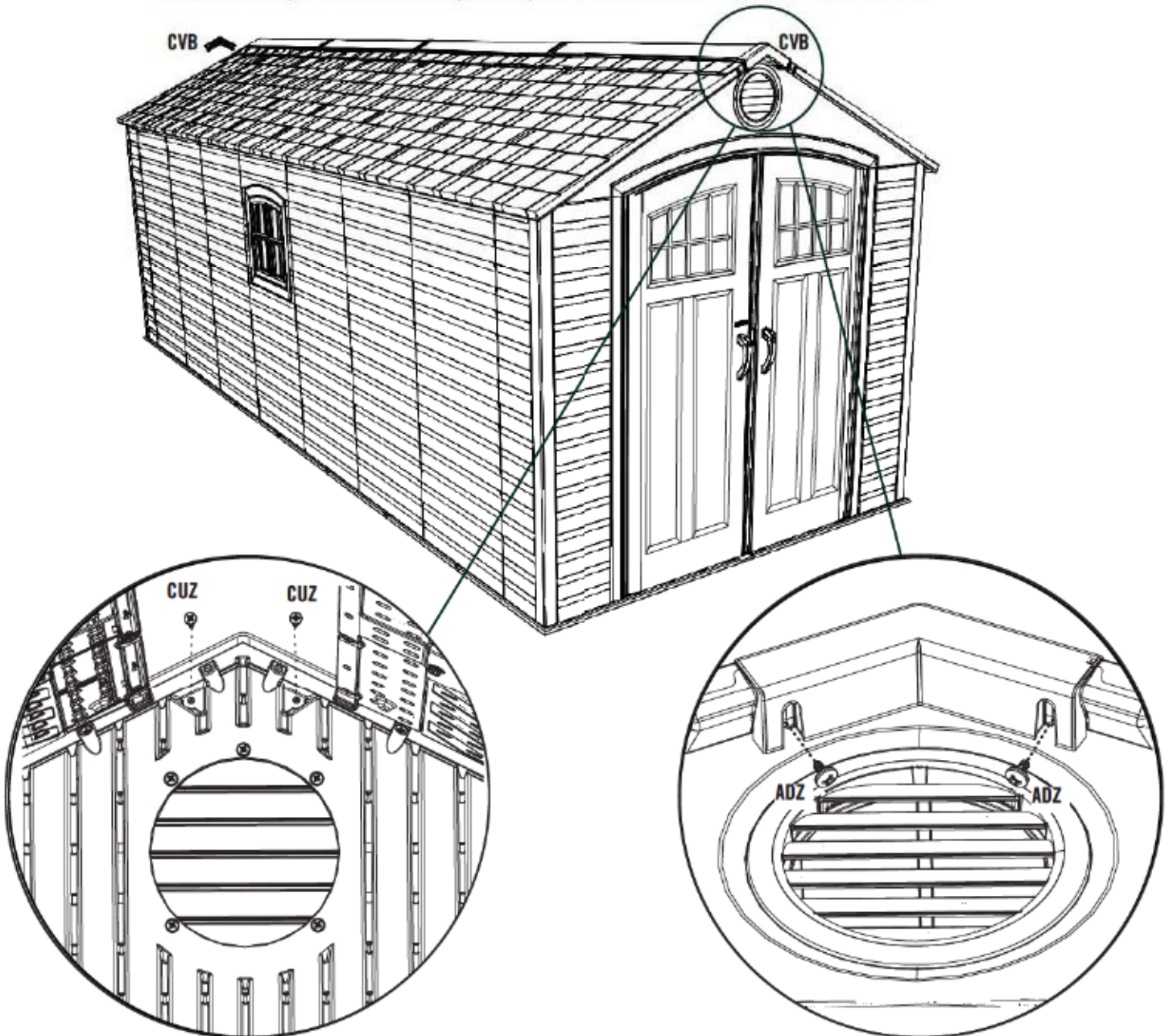

## ► SECTION 10 (CONTINUED) / SECCIÓN 10 (CONTINUACIÓN) / SECTION 10 (SUITE)

TOOLS AND HARDWARE REQUIRED / INSTRUMENTAL Y HERRAJE REQUERIDO / OUTILS ET QUINCAILLERIE REQUIS

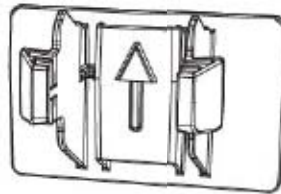

AXX (x2)

### 10.29

- Insert the **Clips (AXX)** with the "arrow" facing up.
- Inserte los **Clips (AXX)** con la «flecha» hacia arriba.
- Insérez les **Clips (AXX)** avec la « flèche » vers le haut.

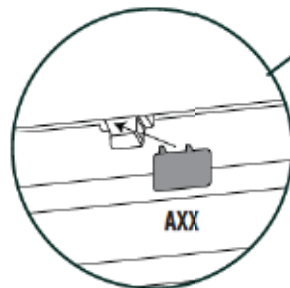
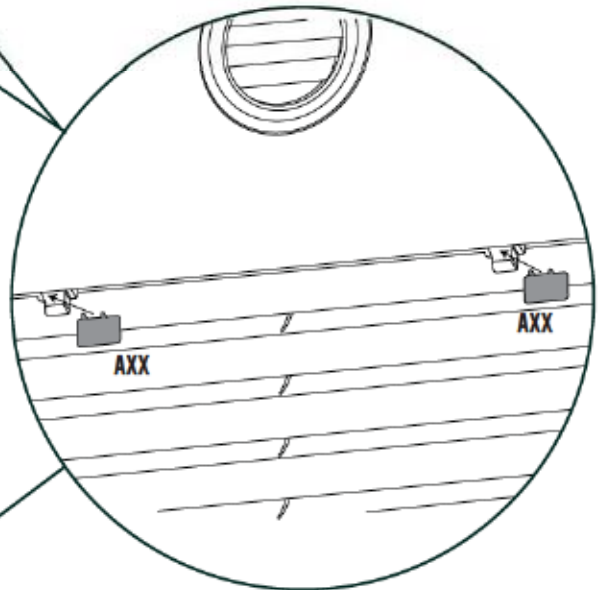
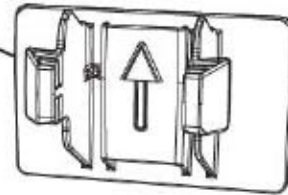
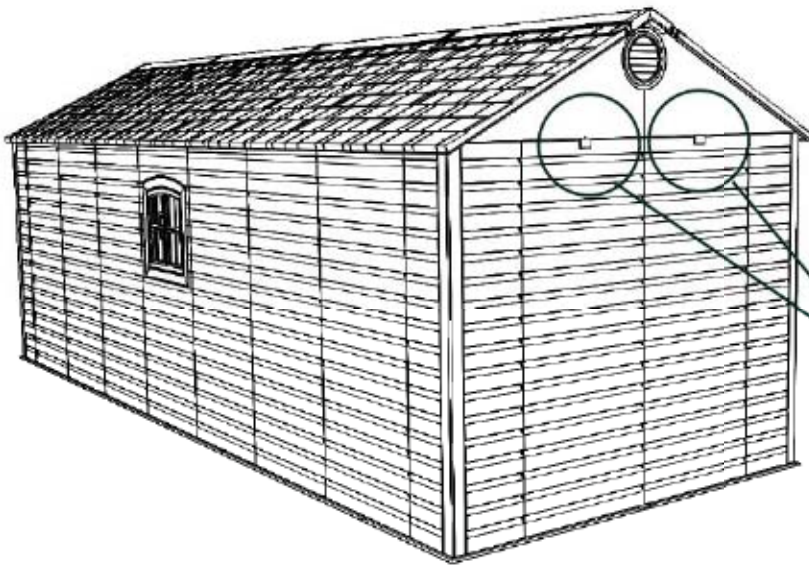

## ► SECTION 10 (CONTINUED) / SECCIÓN 10 (CONTINUACIÓN) / SECTION 10 (SUITE)

TOOLS AND HARDWARE REQUIRED / INSTRUMENTAL Y HERRAJE REQUERIDO / OUTILS ET QUINCAILLERIE REQUIS



3/8"  
(10 mm)

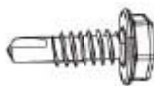

BRK (x56)

### 10.30



• Use an electric Drill to insert two **Screws (BRK)** through the Gusset and into the Gutter Channel. These are the Screws left over from **Section 2: Truss Assembly**. Repeat this step for both sides and both ends of each Truss. You must use an electric drill and 3/8" (10 mm) nut driver for this step.

• Use un taladro eléctrico para insertar dos **Tornillos (BRK)** a través de la Placa de refuerzo y dentro del Canalón de cercha. Estos son los Tornillos restantes de la **Sección 2: Ensamble de los armazones**. Repita este paso para los dos lados y los dos extremos de cada Armazón. Es preciso usar un taladro eléctrico y una llave de tuerca de 3/8" (10 mm) para este paso.

• Utilisez une perceuse électrique pour insérer deux **Vis (BRK)** à travers le Gousset et dans le Canal de gouttière. Ces Vis sont celles-ci qui restent de la **Section 2 : Assemblage des fermes**. Répétez cette étape pour les deux côtés et les deux extrémités de chaque Ferme. Il faut utiliser une perceuse électrique et un tournevis à écrou de 3/8" (10 mm) pour cette étape.

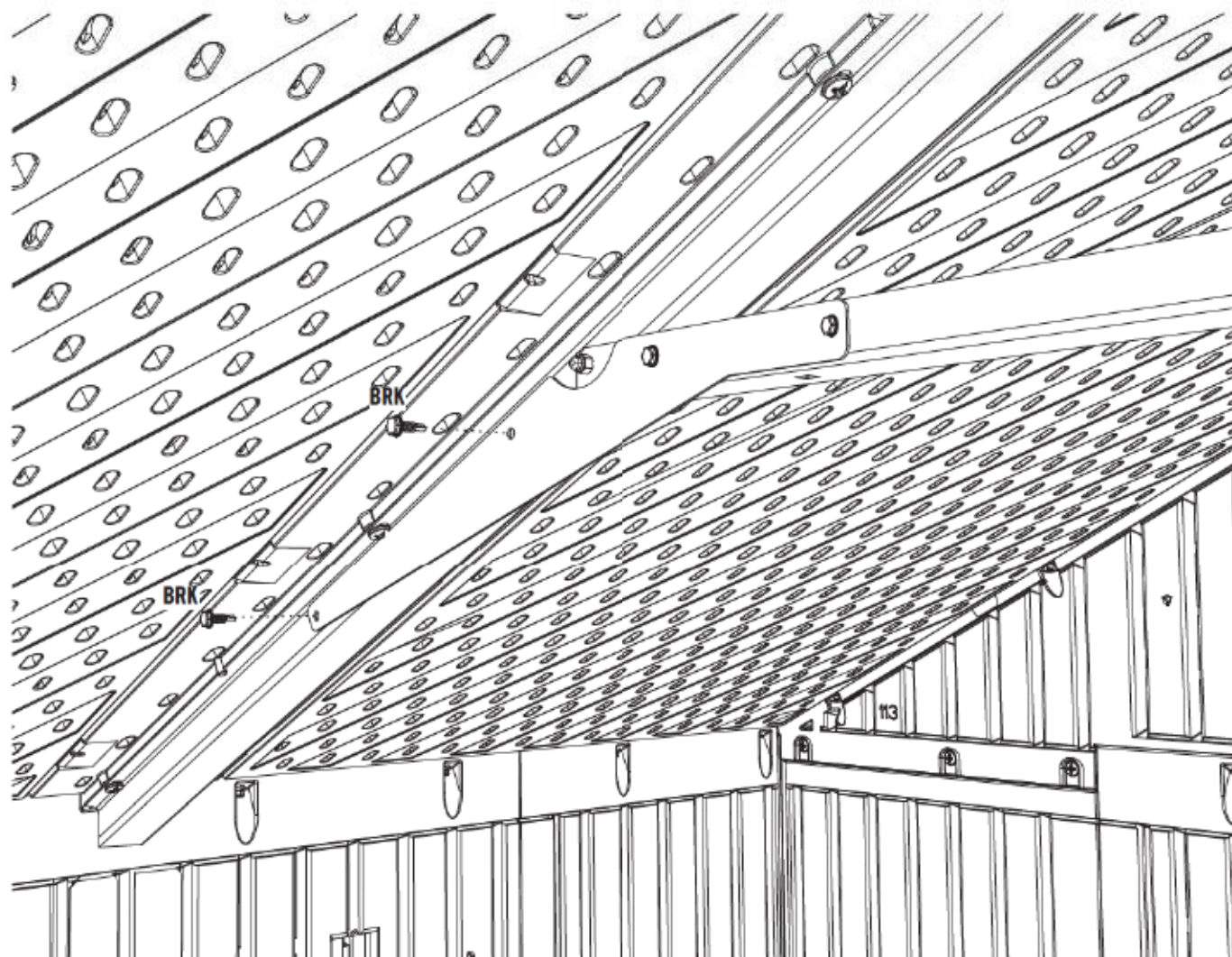

## ► SECTION 10 (CONTINUED) / SECCIÓN 10 (CONTINUACIÓN) / SECTION 10 (SUITE)

TOOLS AND HARDWARE REQUIRED / INSTRUMENTAL Y HERRAJE REQUERIDO / OUTILS ET QUINCAILLERIE REQUIS



3/8"  
(10 mm)



BRK (x28)

### 10.31

- Secure the Small Brace to the Truss Assembly using four (4) Screws (BRK).
- Sujete el Pequeño soporte al Armazón usando cuatro (4) Tornillos (BRK).
- Attachez bien le Petit support à la Ferme à l'aide de quatre (4) Vis (BRK).

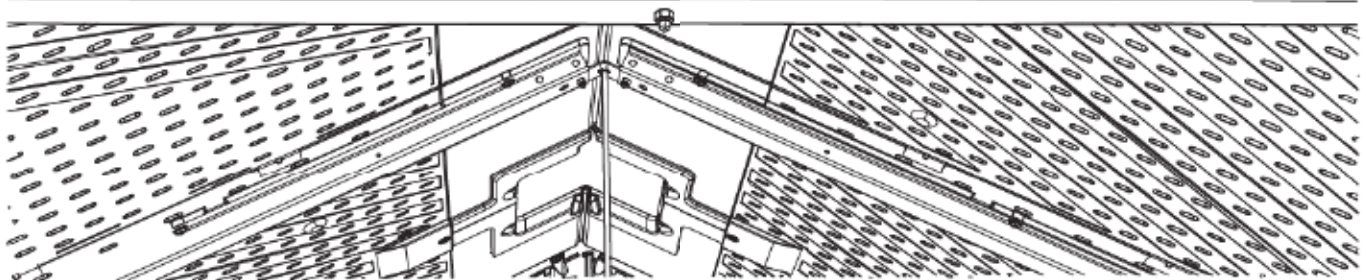
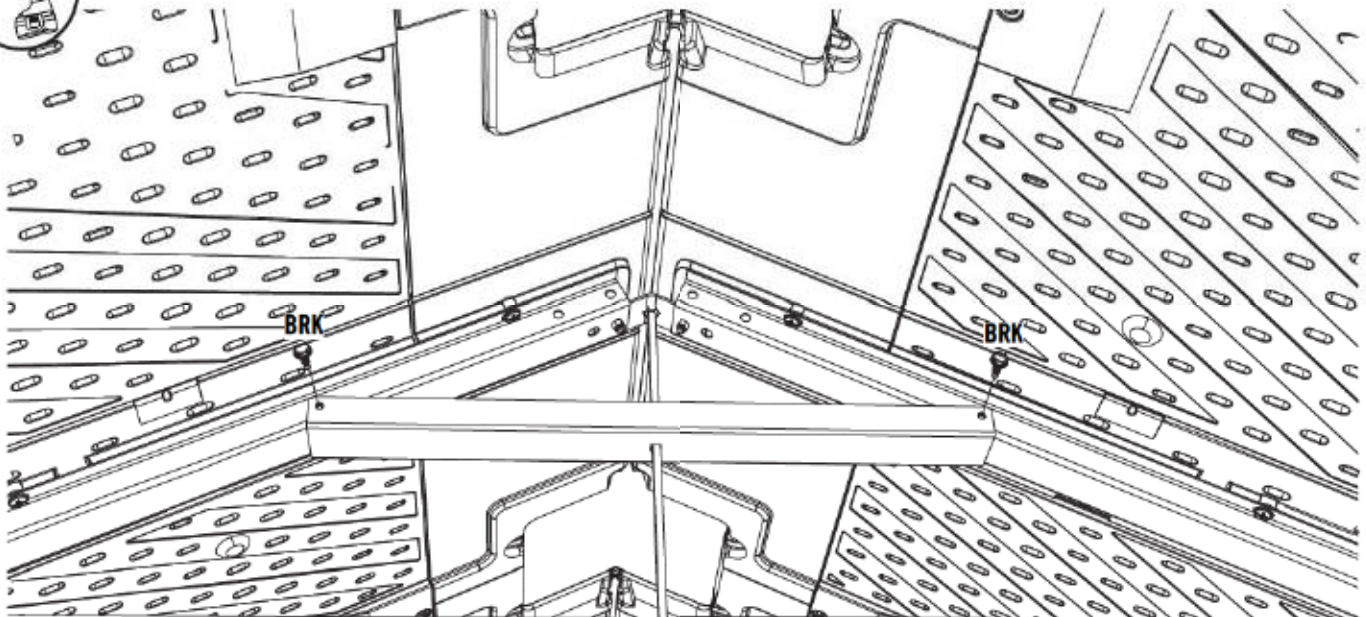

### 10.32

- Repeat the last step for the remaining six Truss Assemblies (seven in all).
- Repita el paso anterior para los seis Conjuntos de cercha restantes (siete en total).
- Répétez l'étape précédente pour les six Montages de ferme restants (sept au total).

**HARDWARE REQUIRED / HERRAJE REQUERIDO / QUINCAILLERIE REQUISE**

Hardware Bag / Bolsa de herraje / Sac de quincaillerie

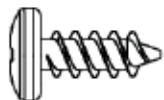

ADZ (x8)



ADY (x2)

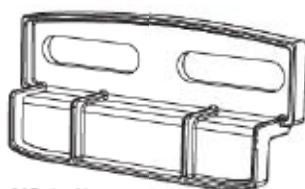

AIS (x4)



ADZ (x28)

**PARTS REQUIRED / PIEZAS REQUERIDAS / PIÈCES REQUISES**

Plastic Parts / Piezas de plástico / Pièces en plastique



AHE (x2)

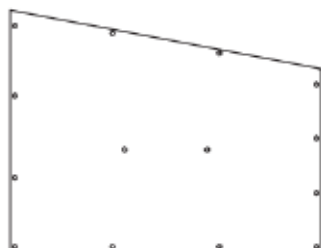

DHN (x2)

**TOOLS REQUIRED / INSTRUMENTAL REQUERIDO / OUTILS REQUIS**



## ► SECTION 11 (CONTINUED) / SECCIÓN 11 (CONTINUACIÓN) / SECTION 11 (SUITE)

TOOLS AND HARDWARE REQUIRED / INSTRUMENTAL Y HERRAJE REQUERIDOS / OUTILS ET QUINCAILLERIE REQUIS

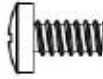

ADY (x2)



- If you have trouble with this section, follow the code below to view a video on how to install the Window Panes.
- Si tiene problemas con esta sección, siga el código debajo para ver un video sobre la instalación de las Hojas de ventana.
- Si vous avez des problèmes avec cette section, suivez le code en bas pour voir un vidéo sur l'installation des Carreaux.



<http://go.lifetime.com/8wininstall>

### 11.1

- Peel off the protective plastic from both sides of the **Window Pane (AHE)**. With the curved edge at the top and facing toward you, slide the Window Pane down into the opening.
- Retire la película protectora de las dos caras de la **Hoja de ventana (AHE)**. Con el borde curvado hacia arriba y el interior, deslice la Hoja en su lugar.
- Enlevez la pellicule protectrice des deux côtés du **Carreau (AHE)**. Avec le bord courbé vers le haut et faisant face de vous, glissez le Carreau en place.

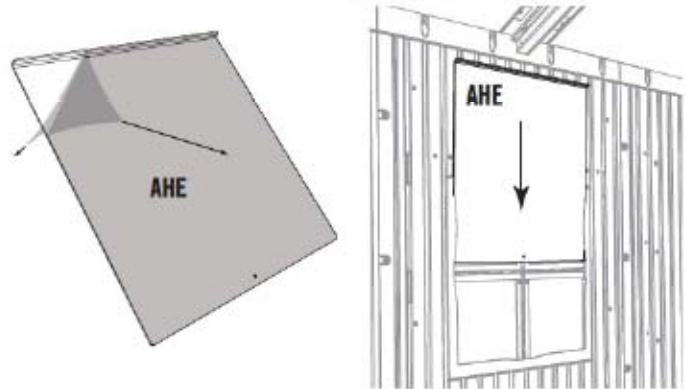

### 11.2

- Insert a **Screw (ADY)** into the hole at the bottom of the Window Pane. This helps keep the Window Pane up when open.
- Introduzca un **Tornillo (ADY)** en el agujero al borde inferior de la Hoja. Esto ayuda a prevenir la cierre de la Hoja.
- Insérez une **Vis (ADY)** dans le trou au bord inférieur du Carreau. Cela aide à maintenir en haut le Carreau lorsqu'il est ouvert.

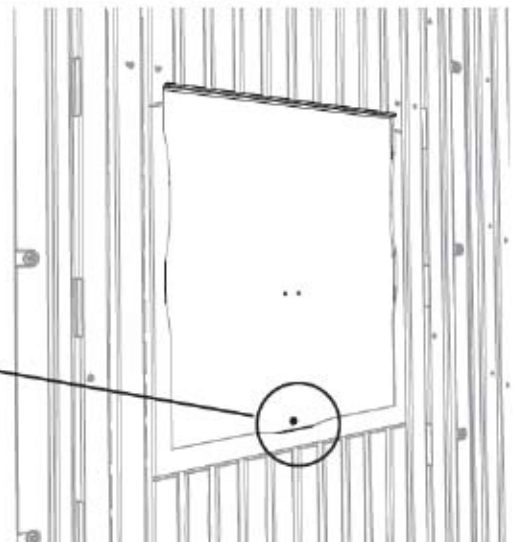
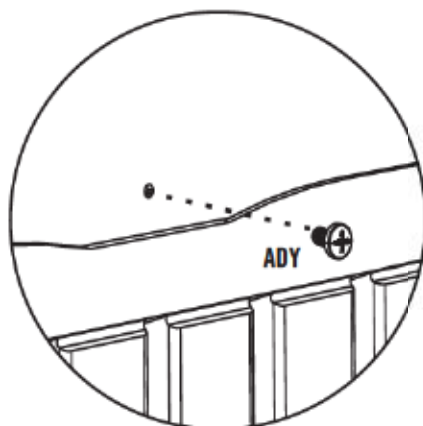

## ► SECTION 11 (CONTINUED) / SECCIÓN 11 (CONTINUACIÓN) / SECTION 11 (SUITE)

TOOLS AND HARDWARE REQUIRED / INSTRUMENTAL Y HERRAJE REQUERIDOS / OUTILS ET QUINCAILLERIE REQUIS

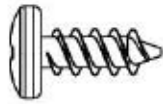

ADZ (x8)

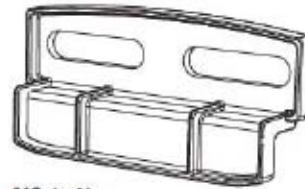

AIS (x4)

### 11.3

- Attach the two (2) **Window Latches (ADY)** at the top corners of the Panel opening. **The Latch should move freely. Repeat steps 11.1–11.3 for the second Window Pane.**
- Sujete los dos (2) **Cerrojos (ADY)** a las esquinas superiores de la abertura del Panel. **El Cerrojo debe mover libremente. Repita los pasos 11.1–11.3 para la segunda Hoja de ventana.**
- Attachez les deux (2) **Loquets (ADY)** aux angles supérieurs de l'ouverture du Panneau. **Le Loquet doit se déplacer librement. Répétez les étapes 11.1 – 11.3 pour le deuxième Carreau.**

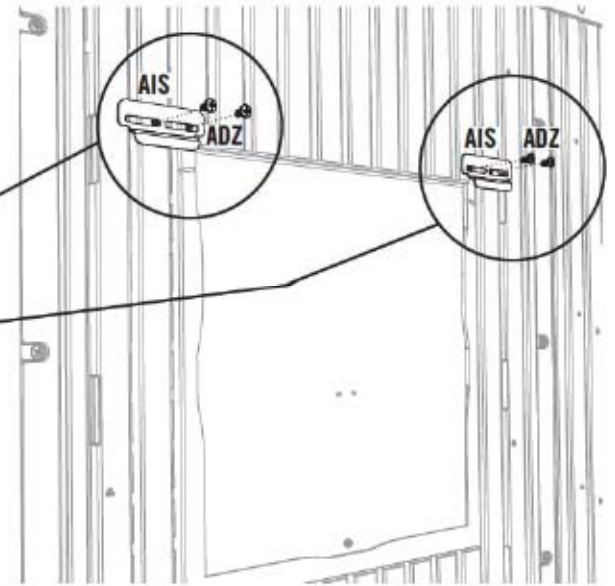
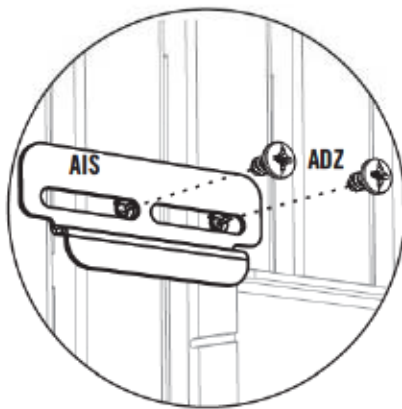

### 11.4

- *If you have trouble with this section, follow the code below to view a video on how to install the Window Panes.*
- *Si tiene problemas con esta sección, siga el código debajo para ver un video sobre la instalación de las Hojas de ventana.*
- *Si vous avez des problèmes avec cette section, suivez le code en bas pour voir un vidéo sur l'installation des Carreaux.*

- Peel off the protective plastic from both sides of the **Window Pane (DHN)**.
- Retire la película protectora de las dos caras de la **Hoja (DHN)**.
- Enlevez la pellicule protectrice des deux côtés du **Carreau (DHN)**.



<http://go.lifetime.com/8-panewindowinstall>

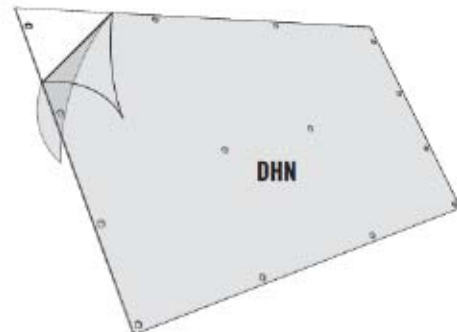

## ► SECTION 11 (CONTINUED) / SECCIÓN 11 (CONTINUACIÓN) / SECTION 11 (SUITE)

TOOLS AND HARDWARE REQUIRED / INSTRUMENTAL Y HERRAJE REQUERIDOS / OUTILS ET QUINCAILLERIE REQUIS

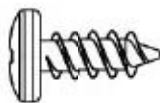

ADZ (x28)

### 11.5

- Align the holes in the Window Pane with those in the Door. Secure the Pane to the Door using fourteen (14) **Screws (ADZ)**.
- Alinee los agujeros en la Hoja con ellos en la Puerta. Sujete la Hoja a la Puerta usando catorce (14) **Tornillos (ADZ)**.
- Alignez les trous dans le Carreau avec ceux dans la Porte. Attachez le Carreau à la Porte à l'aide de quatorze (14) **Vis (ADZ)**.

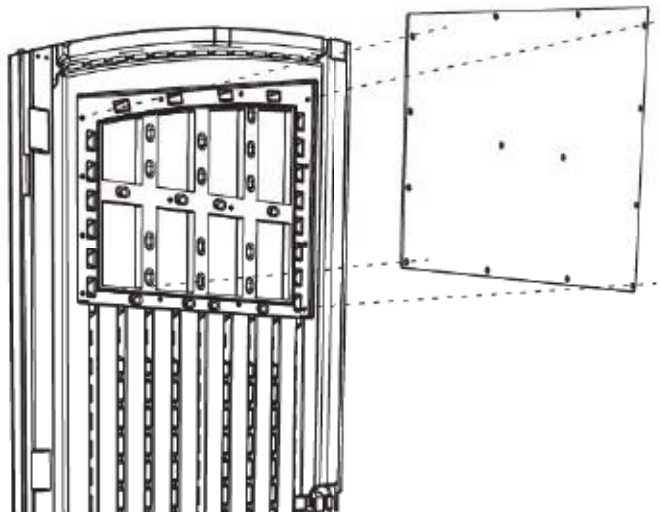

### 11.6

- Repeat steps 11.4–11.6 for the second Door.
- Repita los pasos 11.4–11.6 para la segunda Puerta.
- Répétez les 11.4 – 11.6 étapes pour la deuxième Porte.

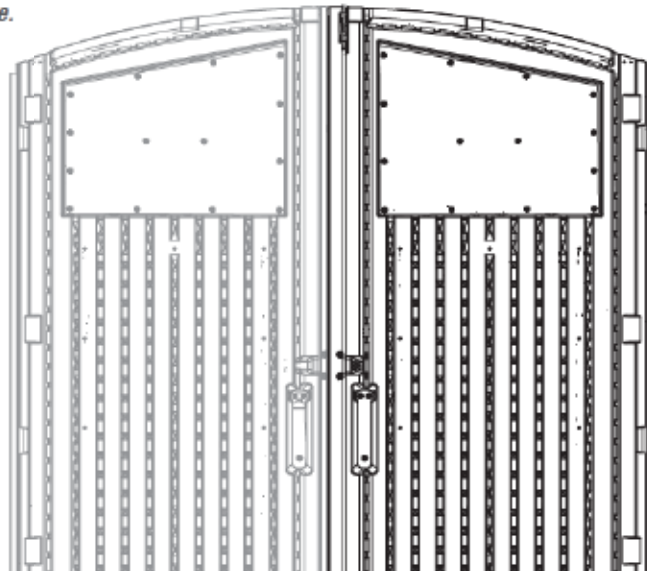

# 12

## PEGBOARD STRIP INSTALLATION / INSTALACIÓN DEL ORGANIZADOR DE HERRAMIENTAS / INSTALLATION DE L'ORGANISEUR D'OUTILS



### HARDWARE REQUIRED / HERRAJE REQUERIDO / QUINCAILLERIE REQUISE

Hardware Bag / Bolsa de herraje / Sac de quincaillerie



ADW (x10)

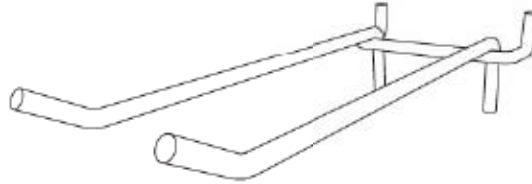

AIG (x1)

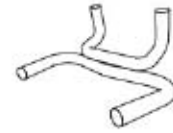

AIJ (x2)

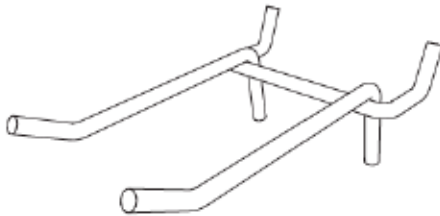

AIF (x1)



AIH (x3)



AII (x3)



### PARTS REQUIRED / PIEZAS REQUERIDAS / PIÈCES REQUISES

Plastic Parts / Piezas de plástico / Pièces en plastique



AFU (x2)



### TOOLS REQUIRED / INSTRUMENTAL REQUERIDO / OUTILS REQUIS



## ► SECTION 12 (CONTINUED) / SECCIÓN 12 (CONTINUACIÓN) / SECTION 12 (SUITE)

TOOLS AND HARDWARE REQUIRED / INSTRUMENTAL Y HERRAJE REQUERIDO / OUTILS ET QUINCAILLERIE REQUIS

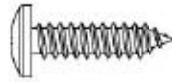

ADW (x10)



- If you have trouble with this section, follow the code below to view a video on how to install the Pegboard Strips.
- Si tiene problemas con esta sección, siga el código debajo para ver un video sobre la instalación de los Organizadores.
- Si vous avez des problèmes avec cette section, suivez le code en bas pour voir un vidéo sur l'installation des Organiseurs.

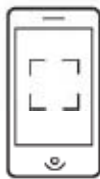

<http://go.lifetime.com/pegboard>

### 12.1

- Attach the **Pegboard Strip (AFU)** to a Wall Panel using five (5) **Screws (ADW)**. Avoid placing screw holes over grooves. Avoid Window Wall Panels. **You may attach the Strip to any Wall Panel.**
- Sujete el **Organizador de herramientas (AFU)** a un Panel de pared usando cinco (5) **Tornillos (ADW)**. Evite colocar los agujeros para los tornillos encima de las ranuras. Evite los Paneles para la ventana. **Se puede sujetar el Organizador a cualquier Panel mural.**
- Attachez l'**Organiseur d'outils (AFU)** au Panneau mural à l'aide de cinq (5) **Vis (ADW)**. Évitez placer les trous pour les vis au-dessus des rainures. Évitez les Panneaux pour la fenêtre. **Vous pouvez attacher l'Organiseur à n'importe quel Panneau mural.**



AFU

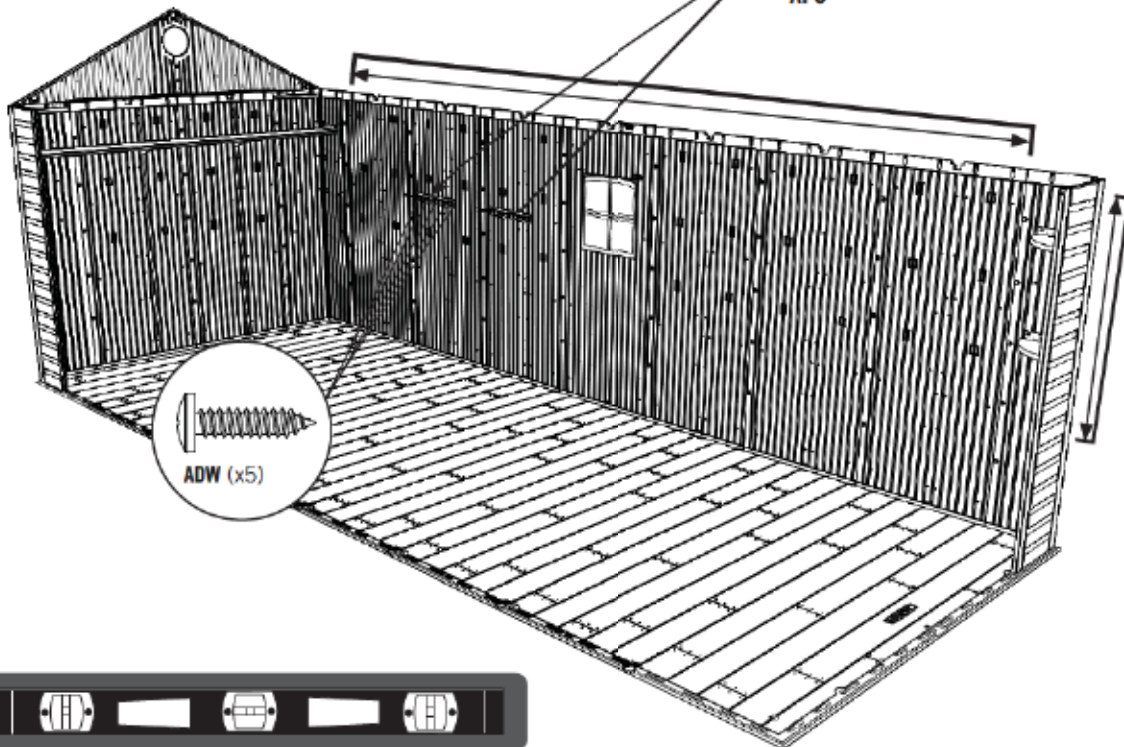

ADW (x5)



## ► SECTION 12 (CONTINUED) / SECCIÓN 12 (CONTINUACIÓN) / SECTION 12 (SUITE)

TOOLS AND HARDWARE REQUIRED / INSTRUMENTAL Y HERRAJE REQUERIDO / OUTILS ET QUINCAILLERIE REQUIS

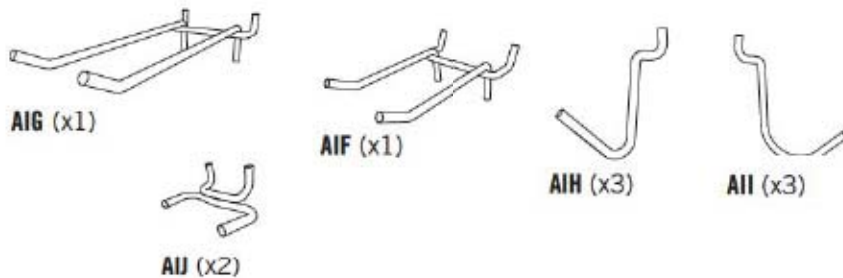

### 12.2

- Insert the various **Hooks (AIF, AIG, AIH, AII, AIJ)** as shown.
- Inserte los varios **Ganchos (AIF, AIG, AIH, AII, AIJ)** como se muestra.
- Insérez les divers **Crochets (AIF, AIG, AIH, AII, AIJ)** comme illustré.

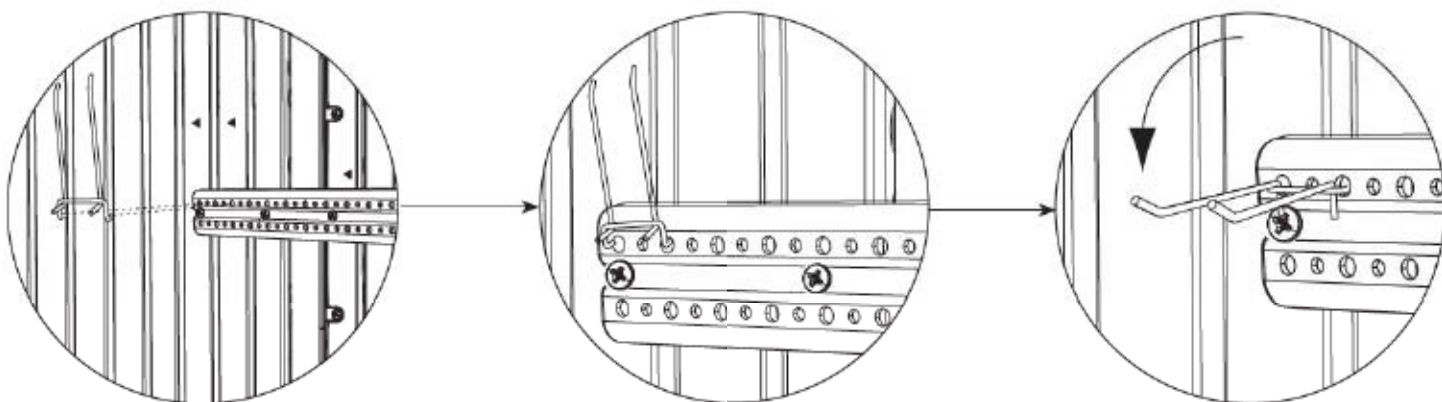

### 12.3

- Repeat this section for the second Pegboard Strip.
- Repita esta sección para el segundo Organizador de herramientas.
- Répétez cette section pour le deuxième Organiseur d'outils.

# 13

## SHUTTER INSTALLATION / INSTALACIÓN DE LAS CONTRAVENTANAS / INSTALLATION DES VOLETS



### HARDWARE REQUIRED / HERRAJE REQUERIDO / QUINCAILLERIE REQUISE

Hardware Bag / Bolsa de herraje / Sac de quincaillerie



ARV (x16)



### PARTS REQUIRED / PIEZAS REQUERIDAS / PIÈCES REQUISES

Plastic Part / Pieza de plástico / Pièce en plastique

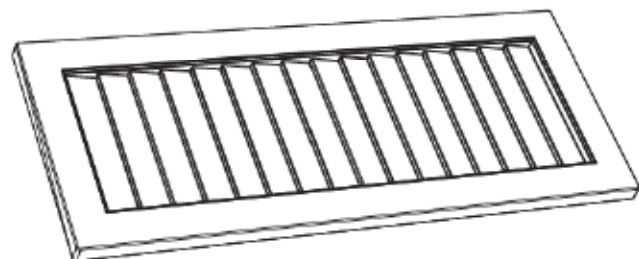

AYI (x4)



### TOOLS REQUIRED / INSTRUMENTAL REQUERIDO / OUTILS REQUIS



## ► SECTION 13 (CONTINUED) / SECCIÓN 13 (CONTINUACIÓN) / SECTION 13 (SUITE)

TOOLS AND HARDWARE REQUIRED / INSTRUMENTAL Y HERRAJE REQUERIDO / OUTILS ET QUINCAILLERIE REQUIS



ARV (x1)



• If you have trouble with this section, follow the code below to view a video on how to install the Shutters.

• Si tiene problemas con esta sección, siga el código debajo para ver un video sobre la instalación de las Contraventanas.

• Si vous avez des problèmes avec cette section, suivez le code en bas pour voir un vidéo sur l'installation des Volets.

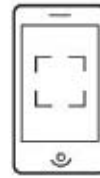

<http://go.lifetime.com/8horizshutter>

### 13.1

• There are four sets of two screw location indicators. **The measurements are shown to help you locate them.** One by one, insert the **Screws (ARV)** through the indicators from the inside of the shed outward, and attach the **Shutters (AYI)** to the outside of the Wall Panels. **See step 13.2–13.3**

• Hay cuatro juegos de dos indicadores para la ubicación del tornillo. **Las medidas indican donde se los pueden hallar.** Uno por uno, inserte los **Tornillos (ARV)** por los indicadores del interior al exterior, y sujete las **Contraventanas (AYI)** al exterior de los Paneles murales. **Vea el paso 13.2–13.3.**

• Il y a quatre groupes de deux indicateurs pour l'emplacement de la vis. **Les mesures indiquent où vous pouvez les trouver.** Une par une, insérez les **Vis (ARV)** à travers les indicateurs de l'intérieur à l'extérieur, et attachez les **Volets (AYI)** à l'extérieur des Panneaux muraux. **Voyez l'étape 13.2 – 13.3.**

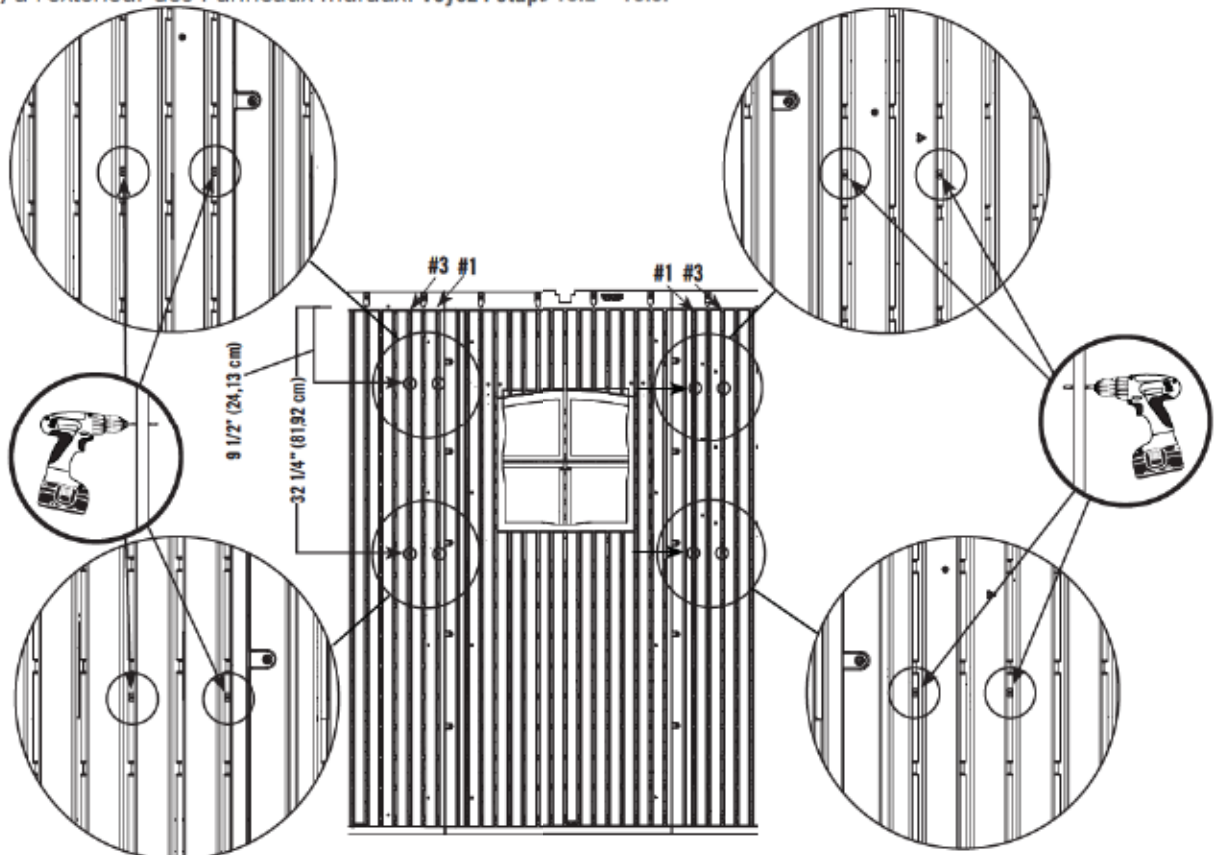



## ► SECTION 13 (CONTINUED) / SECCIÓN 13 (CONTINUACIÓN) / SECTION 13 (SUITE)

TOOLS AND HARDWARE REQUIRED / INSTRUMENTAL Y HERRAJE REQUERIDO / OUTILS ET QUINCAILLERIE REQUIS

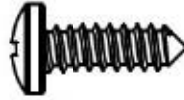

ARV (x7)

### 13.2



- Align the screw bosses in the **Shutter (AYI)** with the holes in the Wall Panels. Secure the Shutter to the Panels using the **Screws (ARV)** provided.
- Alinee los huecos de montaje en la **Contraventana (AYI)** con los agujeros en los Paneles murales. Sujete la Contraventana a los Paneles usando los **Tornillos (ARV)** incluidos.
- Alignez les bossages de montage dans le **Volet (AYI)** avec les trous dans les Panneaux muraux. Attachez le Volet aux Panneaux à l'aide des **Vis (ARV)** fournies.

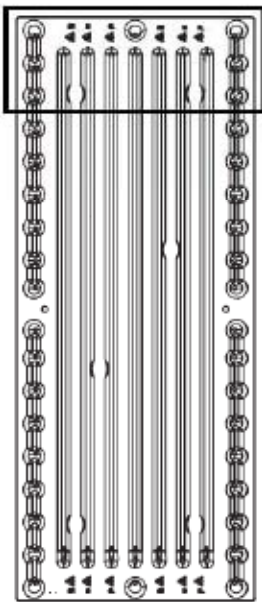

AYI

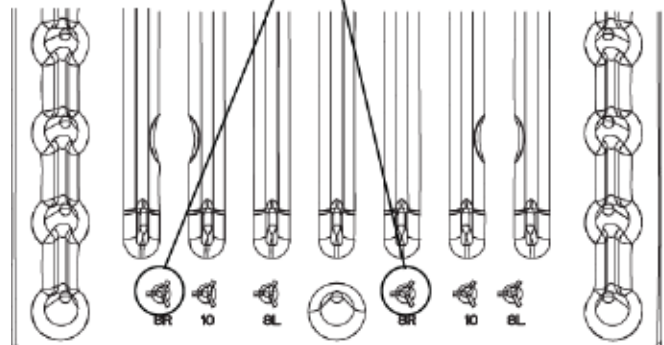
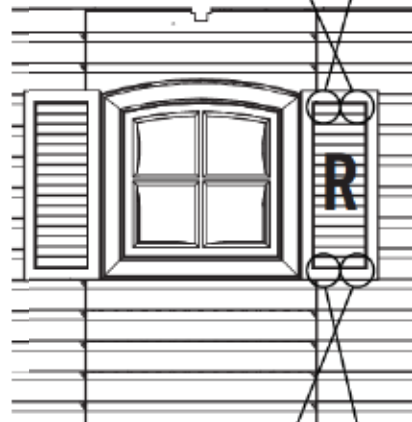
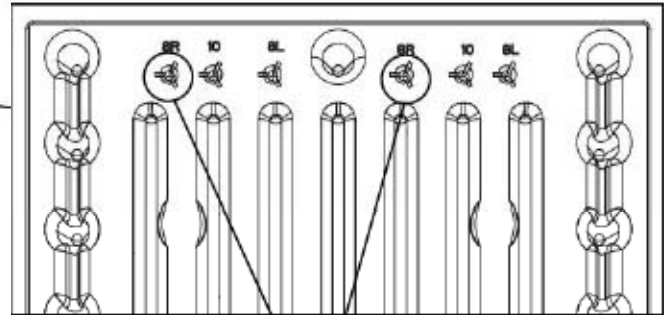

## ► SECTION 13 (CONTINUED) / SECCIÓN 13 (CONTINUACIÓN) / SECTION 13 (SUITE)

TOOLS AND HARDWARE REQUIRED / INSTRUMENTAL Y HERRAJE REQUERIDO / OUTILS ET QUINCAILLERIE REQUIS

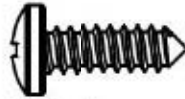

ARV (x8)

### 13.3



- Align the screw bosses in the **Shutter (AYI)** for the left side of the Window with the holes in the Wall Panels. Secure the Shutter to the Panel using the **Screws (ARV)** included.
- Alinee los huecos de montaje en la **Contraventana (AYI)** para el lado izquierdo de la Ventana con los agujeros en los Paneles murales. Sujete la Contraventana al Panel usando los **Tornillos (ARV)** incluidos.
- Alignez les bossages de montage dans le **Volet (AYI)** pour le côté gauche de la Fenêtre avec les trous dans les Panneaux muraux. Attachez le Volet aux Panneaux à l'aide des **Vis (ARV)** inclus.

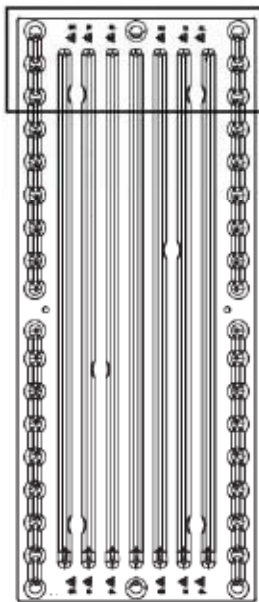

AYI

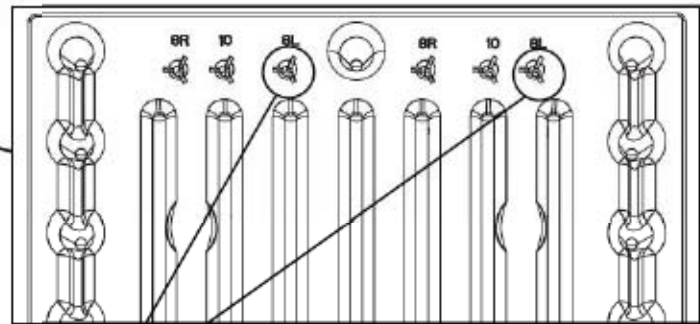

### 13.4

- Repeat this section for the second Window.
- Repita esta sección para la segunda Ventana.
- Répétez cette section pour la deuxième Fenêtre.

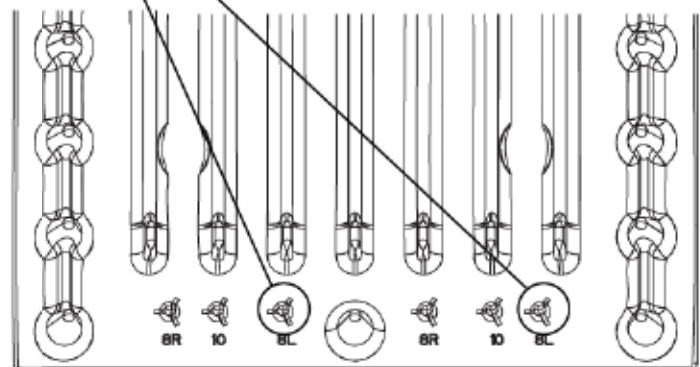

# 14

## DOOR ALIGNMENT / ALINEACIÓN DE LAS PUERTAS / ALIGNEMENT DES PORTES



### HARDWARE REQUIRED / HERRAJE REQUERIDO / QUINCAILLERIE REQUISE

**NO HARDWARE INCLUDED FOR THIS SECTION  
NINGÚN HERRAJE INCLUIDO PARA ESTA SECCIÓN  
AUCUNE QUINCAILLERIE INCLUSE POUR CETTE SECTION**



### PARTS REQUIRED / PIEZAS REQUERIDAS / PIÈCES REQUISES

*Wood Parts / Piezas de madera / Pièces en bois*

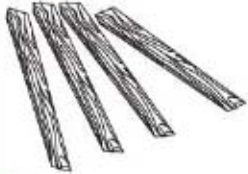

**AIX (x4)**



### TOOLS REQUIRED / INSTRUMENTAL REQUERIDO / OUTILS REQUIS



## ► SECTION 14 (CONTINUED) / SECCIÓN 14 (CONTINUACIÓN) / SECTION 14 (SUITE)

TOOLS AND HARDWARE REQUIRED / INSTRUMENTAL Y HERRAJE REQUERIDO / OUTILS ET QUINCAILLERIE REQUIS



### 14.1

- If you have trouble with this section, follow the code below to view a video on how to align the Doors.
- Si tiene problemas con esta sección, siga el código debajo para ver un video sobre la alineación de las Puertas.
- Si vous avez des problèmes avec cette section, suivez le code en bas pour voir un vidéo sur l'alignement des Portes.

- If the Doors are not even at the top, follow the steps on this page to align them.
- Si las Puertas no están alineadas a la parte superior, siga los pasos en esta página para alinearlas.
- Si les Portes ne sont pas alignées l'une avec l'autre à la partie supérieure, suivez les étapes dans cette page pour les aligner.



<http://go.lifetime.com/8alignment>



### 14.2

- If the Right Door scrapes the Floor or is lower than the Left Door, insert a **Shim (AIX)** under the Floor directly under the bottom corner of the Right Door and/or the left rear corner of the shed. If necessary, repeat for the Left Door until both Doors are level and do not scrape. **Break off any excess Shim.**
- Si la Puerta derecha se roza con el Piso o es más bajo que la Izquierda, inserte una **Cuña (AIX)** debajo el Piso directamente debajo la esquina inferior derecha de la Puerta derecha y/o la esquina izquierda trasera de la caseta. Si es necesario, repita este paso para la Puerta izquierda o hasta que las dos Puertas estén niveladas y no se rocen. **Quebrante cualquier exceso de las Cuñas.**
- Si la Porte droite frotte en se ferment ou est plus bas que la Porte gauche, insérez une **Cale (AIX)** sous le Plancher directement sous le coin droit inférieur de la Porte droite et/ou l'encoignure arrière gauche de l'abri. S'il est nécessaire, répétez cette étape pour la Porte gauche jusqu'à ce que les deux Portes soient nivelles et ne frottent pas. **Détachez de l'excès des Cales.**

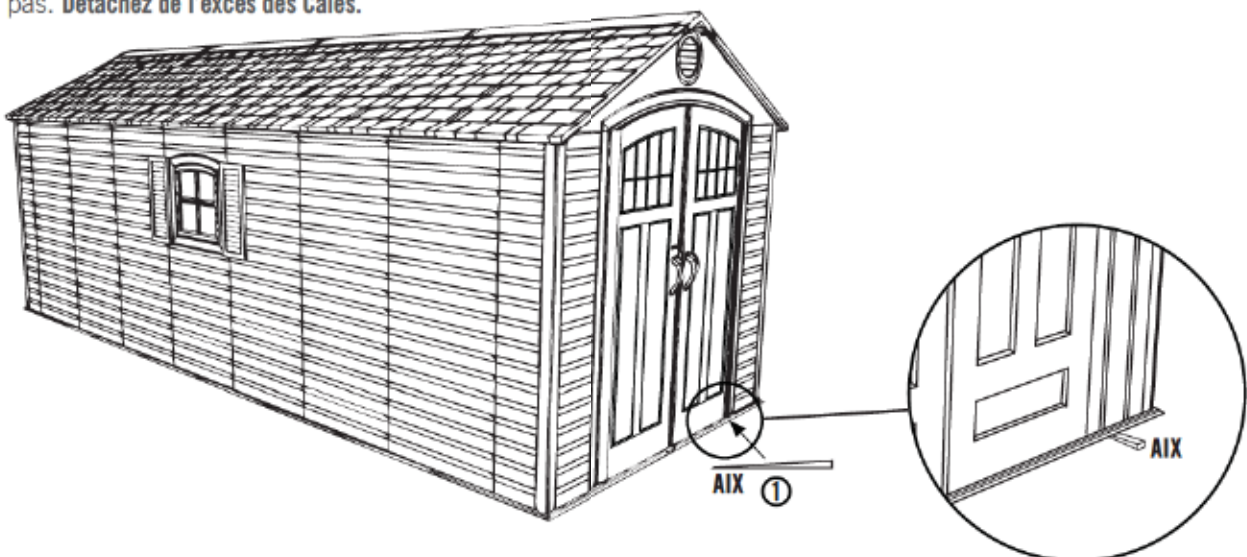



**HARDWARE REQUIRED / HERRAJE REQUERIDO / QUINCAILLERIE REQUISE**

**NO HARDWARE INCLUDED FOR THIS SECTION  
NINGÚN HERRAJE INCLUIDO PARA ESTA SECCIÓN  
AUCUNE QUINCAILLERIE INCLUSE POUR CETTE SECTION**

**PARTS REQUIRED / PIEZAS REQUERIDAS / PIÈCES REQUISES**

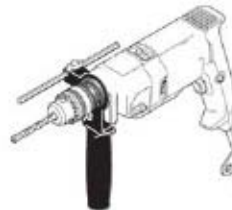
**NO PARTS REQUIRED FOR THIS SECTION  
NINGUNA PIEZA REQUERIDA PARA ESTA SECCIÓN  
AUCUNE PIÈCE REQUISE POUR CETTE SECTION**

**TOOLS REQUIRED / INSTRUMENTAL REQUERIDO / OUTILS REQUIS**

  
5/16" (8 mm) Wood Drill Bit  
5/16" (8 mm) Broca para madera  
5/16" (8 mm) Foret à bois

  
5/16" (8 mm) Masonry Drill Bit  
5/16" (8 mm) Broca para albañilería  
5/16" (8 mm) Foret à maçonnerie

## ► SECTION 15 (CONTINUED) / SECCIÓN 15 (CONTINUACIÓN) / SECTION 15 (SUITE)

FOR CONCRETE PLATFORMS / PARA PLATAFORMAS DE CONCRETO / POUR LES PLATE-FORMES EN BÉTON



### 15.1



• To anchor your shed, you must purchase the correct anchoring hardware. **For a concrete platform**, we recommend using a hammer drill, 5/16" (8 mm) masonry bit, sixteen (16) 3/8" x 2" (10 mm x 5 cm) Concrete Screws and sixteen (16) 3/8" x 1" (10 mm x 2,5 cm) Fender Washers. **Do not exceed a 3/8" diameter screw. Refer to your local hardware store for this hardware.**

• Para anclar la caseta, es necesario comprar el herraje de anclaje correcto. **Para una plataforma de concreto**, recomendamos que use un martillo perforador, broca de albañilería de 8 mm (5/16"), dieciséis (16) Tornillos de anclaje para concreto de 10 mm x 5 cm (3/8" x 2") y dieciséis (16) Rondanas de protección de 10 mm x 2,5 cm (3/8" x 1"). **No exceda un diámetro de 10 mm (3/8"). Refiérase a su ferretería local para obtener estos elementos.**

• Pour ancrer l'abri, il faut acheter la quincaillerie d'ancrage correcte. **Pour une plate-forme en béton**, nous recommandons que vous utilisiez une perceuse de percussion, un foret à maçonnerie de 8 mm (5/16"), seize (16) Vis d'ancrage à béton de 10 mm x 5 cm (3/8" x 2") et seize (16) Rondelles de protection de 10 mm x 2,5 cm (3/8" x 1"). **Ne dépassez pas un diamètre de 10 mm (3/8"). Votre quincaillerie du coin aura ces accessoires.**

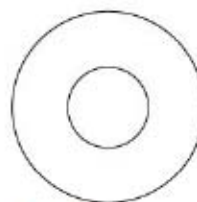
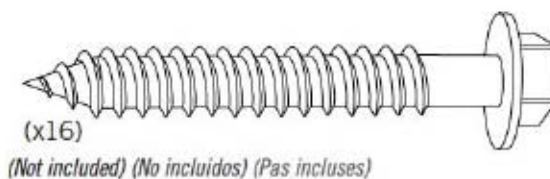
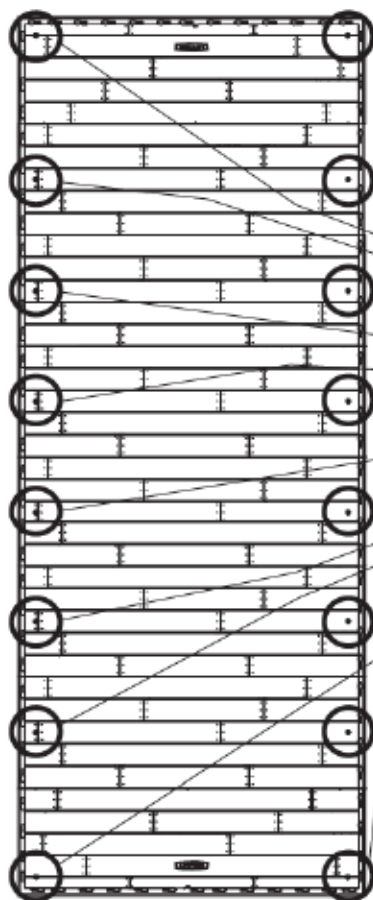

- Failure to anchor the shed may result in property damage and/or personal injury.
- El incumplimiento de anclar la caseta podría ocasionar daño a la propiedad y/o lesiones personales.
- Le non-respect d'ancrer l'abri peut résulter en dommage à propriété et/ou blessures graves personnelles.
- シェッドにアンカーを付けない場合は、物的損害や身体傷害が生じる可能性があります。

## ▶ SECTION 15 (CONTINUED) / SECCIÓN 15 (CONTINUACIÓN) / SECTION 15 (SUITE)

FOR WOOD PLATFORMS / PARA PLATAFORMAS DE MADERA / POUR LES PLATE-FORMES EN BOIS



5/16" (8 mm)



### 15.1



• To anchor your shed, you must purchase the correct anchoring hardware. **For a wood-framed platform, we recommend using a drill, 5/16" (8 mm) drill bit, sixteen (16) 3/8" x 1 1/2" (10 mm x 4 cm) Lag Screws and sixteen (16) 3/8" x 1" (10 mm x 2,5 cm) Fender Washers. Do not exceed a 3/8" diameter screw. Refer to your local hardware store for this hardware.**

• Para anclar la caseta, es necesario comprar el herraje de anclaje correcto. **Para una plataforma hecho de hecho de madera, recomendamos que use un taladro eléctrico, una broca de 8 mm (5/16"), dieciséis (16) Tornillos para madera de 10 mm x 4 cm (3/8" x 1 1/2") y dieciséis (16) Rondanas de protección de 10 mm x 2,5 cm (3/8" x 1"). No exceda un diámetro de 10 mm (3/8"). Refiérase a su ferretería local para obtener estos elementos.**

• Pour ancrer l'abri, il faut acheter la quincaillerie d'ancrage correcte. **Pour une plate-forme en bois, nous recommandons que vous utilisiez une perceuse électrique, un foret de 8 mm (5/16"), seize (16) Vis de retard de 10 mm x 4 cm (3/8" x 1 1/2"), et seize (16) Rondelles de protection de 10 mm x 2,5 cm (3/8" x 1"). Ne dépassez pas un diamètre de 10 mm (3/8"). Votre quincaillerie du coin aura ces accessoires.**

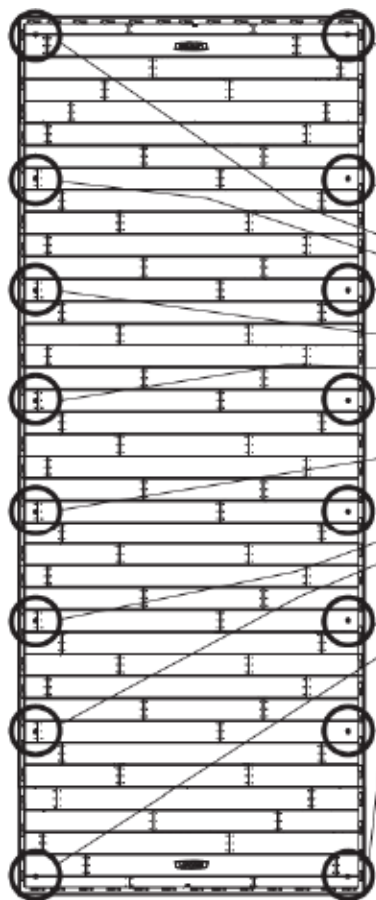

(x16)

(Not included) (No incluidos) (Pas incluses)

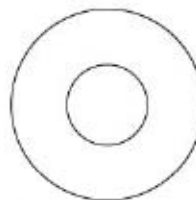

(x16)

(Not included) (No incluidas) (Pas incluses)



- Failure to anchor the shed may result in property damage and/or personal injury.
- El incumplimiento de anclar la caseta podría ocasionar daño a la propiedad y/o lesiones personales.
- Le non-respect d'ancrer l'abri peut résulter en dommage à propriété et/ou blessures graves personnelles.
- シェッドにアンカーを付けない場合は、物的損害や身体傷害が生じる可能性があります。



**NOTES / NOTAS / REMARQUES**

A large, empty white rectangular area intended for writing notes or remarks, occupying the majority of the page's vertical space.





**NOTES / NOTAS / REMARQUES**

A large, empty white rectangular area intended for writing notes or remarks, occupying the majority of the page below the header.



**NOTES / NOTAS / REMARQUES**

A large, empty white rectangular area intended for writing notes or remarks, occupying the majority of the page below the header.



## CLEANING & CARE

**Congratulations on your Lifetime® product purchase. By following the instructions below, your new Lifetime product should provide you with years of service and enjoyment.**

The polyethylene panels are stain- and solvent-resistant. Most stains can be removed using a mild soap and a soft-bristled brush. Abrasive cleaning materials may scratch the plastic and are not recommended. Repair scratches or rust spots on the metal by sanding the affected area lightly; using a rust preventative spray primer; and finally, spraying with a high-gloss spray enamel paint. Avoid placing a direct heat source on or near surfaces unless using a heat barrier.



## LIMPIEZA Y CUIDADO

**Felicidades por la compra de su producto Lifetime®. Si cumple todas las instrucciones siguientes, podrá disfrutar satisfactoriamente del servicio de su nuevo producto Lifetime.**

Las paredes y los estantes de polietileno son resistentes a las manchas y al solvente. Use para su limpieza un jabón suave y un cepillo de cerdas blandas. Los materiales limpiadores abrasivos podrían raspar el plástico y no son recomendados. Repare las raspaduras o zonas oxidadas de las piezas de metal lijando ligeramente el área afectada; aplique luego una impresión en aerosol para prevenir la formación de óxido; finalmente pinte con un esmalte brillante en aerosol. Evite colocar una fuente directa de calor sobre las superficies o cerca de ellas a menos que use una barrera contra el calor.



## NETTOYAGE ET ENTRETIEN

**Nous vous félicitons d'avoir acheté ce produit Lifetime®. En suivant les instructions ci-dessous, votre nouvel produit Lifetime devrait vous fournir des années de service et de plaisir.**

Les murs et les étagères en polyéthylène sont résistants aux tâches et solvants de nettoyage. Pour les nettoyer, servez-vous d'un savon doux et d'une brosse douce. Les produits abrasifs de nettoyage risquent d'égratigner le plastique et ne sont pas recommandés. Pour réparer les égratignures ou tâches de rouille sur le métal, frottez légèrement l'endroit affecté ou papier de verre, puis passez un couche de produit vaporisant préventif et enfin vaporisez une peinture émail brillant élevé. Évitez de placer une source de chaleur directe sur ou près des surfaces, ou protégez-les à l'aide d'une protection contre la chaleur.



## REGISTER YOUR PRODUCT ONLINE AT WWW.LIFETIME.COM

At Lifetime®, we are committed to providing innovative and quality products. While registering, you will have the opportunity to give us your feedback. Your input is valuable to us.

- You can also opt in to receive new product notifications or promotions.
- In the unlikely event of a product recall or safety modification, your registration provides the information we need to notify you directly.
- Registration is fast, easy, and completely voluntary.

### LIFETIME'S PROMISE TO YOU:

*Maintaining your privacy is our long-standing policy at Lifetime®. And you can rest assured that Lifetime® will not sell or provide your personal data to other third parties, or allow them to use your personal data for their own purposes.*

We invite you to read our privacy policy at [www.lifetime.com](http://www.lifetime.com)

**REGISTER today!**



## REGISTRE SU PRODUCTO EN LÍNEA EN WWW.LIFETIME.COM

À Lifetime®, estamos comprometidos a proporcionar productos de calidad e innovadores. Al registrar, tendrá la oportunidad de darnos su opinión. Su opinión es muy valiosa para nosotros.

- Se puede optar inclusión también para recibir notificaciones de nuevos productos o promociones.
- En el caso poco probable de una retirada de un producto o modificación de seguridad, su registro nos provee la información necesario de notificarle directamente.
- El registro es rápido, fácil, y completamente voluntario.

### LA PROMESA DE LIFETIME® A USTED:

*Mantener su privacidad, es nuestro viejo acuerdo político a Lifetime®. Y puede tener la seguridad de que Lifetime® no venderá ni proveerá sus datos personales a otros terceros, ni les permitirá usar sus datos personales para sus propias intenciones.*

Le invitamos a leer nuestra política de privacidad en [www.lifetime.com](http://www.lifetime.com)

**¡REGÍSTRELO hoy!**



## ENREGISTREZ VOTRE ARTICLE EN LIGNE CHEZ NOUS À WWW.LIFETIME.COM

À Lifetime®, nous sommes engagés à fournir des produits innovants et de qualité. Lors de l'enregistrement, vous aurez l'occasion de nous donner votre avis. Vos remarques sont précieuses pour nous.

- Vous pouvez aussi vous engager pour recevoir notifications d'articles nouveaux et promotions.
- En cas improbable de retrait de produit du marché ou de modification affectant la sécurité, votre enregistrement nous fournit l'information nécessaire de vous contacter directement.
- L'enregistrement est rapide, simple, et complètement volontaire.

### LA PROMESSE DE LIFETIME® À VOUS :

*À Lifetime®, l'entretien de votre confidentialité est notre politique de longue date. Et vous pouvez être sûr que Lifetime® ne vendra pas ni fournira pas vos données personnelles à d'autres tiers, ou les permettra d'utiliser vos données personnelles à leur propres fins.*

Nous vous invitons à lire notre politique de confidentialité à [www.lifetime.com](http://www.lifetime.com)

**ENREGISTREZ aujourd'hui !**



## 10-YEAR LIMITED FACTORY WARRANTY

**THE MANUFACTURER RESERVES THE RIGHT TO MAKE SUBSTITUTIONS TO WARRANTY CLAIMS IF PARTS ARE UNAVAILABLE OR OBSOLETE.**

1. Lifetime outdoor sheds are warranted to the original purchaser to be free from defects in material or workmanship for a period of ten years from the date of original retail purchase. The word "defects" is defined as imperfections that impair the use of the product. Defects resulting from misuse, abuse or negligence will void this warranty. This warranty does not cover defects due to improper installation, alteration or accident. This warranty does not cover damage caused by vandalism, rusting, "acts of nature" or any other event beyond the control of the manufacturer.
2. This warranty is nontransferable and is expressly limited to the repair or replacement of defective product. If the product is defective within the terms of this warranty, Lifetime Products, Inc. will repair or replace defective parts at no cost to the purchaser. Shipping charges to and from the factory or distribution center are not covered and are the responsibility of the purchaser. Labor charges and related expenses for removal, installation or replacement of the shed or its components are not covered under this warranty.
3. This warranty does not cover scratching or scuffing of the product that may result from normal usage. In addition, defects resulting from intentional damage, negligence, unreasonable use or hanging from the truss will void this warranty.
4. Liability for incidental or consequential damages is excluded to the extent permitted by law. While every attempt is made to embody the highest degree of safety in all equipment, freedom from injury cannot be guaranteed. The user assumes all risk of injury resulting from the use of this product. All merchandise is sold on this condition, and no representative of the company may waive or change this policy.
5. This product is not intended for institutional or commercial use; Lifetime Products, Inc. does not assume any liability for such use. Institutional or commercial use will void the warranty.
6. Our goods come with guarantees that cannot be excluded under the Australian Consumer Law. You are entitled to a replacement or refund for a major failure and for compensation for any other reasonably foreseeable loss or damage. You are also entitled to have the goods repaired or replaced if the goods fail to be of acceptable quality and the failure does not amount to a major failure.
7. This warranty is expressly in lieu of all other warranties, expressed or implied, including warranties of merchantability or fitness for use to extent permitted by Federal and state law. Neither Lifetime Products, Inc., nor any representative assumes any other liability in connection with this product. This warranty gives you specific legal rights, and you may also have other rights which vary from state to state.

**PLEASE INCLUDE YOUR DATED SALES RECEIPT AND PHOTOGRAPHS OF DAMAGED PARTS.**

REPORT PRODUCT DEFECTS IN WRITING TO:

Lifetime Products, Inc., PO Box 160010 Clearfield, UT 84016-0010  
or call 1-800-225-3865 M-F 7 a.m. to 5 p.m. MST.

**REGISTER YOUR PRODUCT FOR QUICKER CUSTOMER SERVICE.**

Visit [www.lifetime.com](http://www.lifetime.com) or call 1-800-225-3865 to register your product today.

**FOR INTERNATIONAL WARRANTY CLAIMS:**

All warranty claims must be accompanied by a sales receipt. Report all warranty claims in writing to your regional sales support representative. Please include your dated sales receipt and photographs of damaged parts.

To identify the representative for your region, please visit: [www.lifetime.com/international](http://www.lifetime.com/international)



[www.lifetime.com](http://www.lifetime.com)



## GARANTÍA DE FÁBRICA LIMITADA POR 10 AÑOS

**EL FABRICANTE SE RESERVA EL DERECHO DE HACER SUSTITUCIONES EN LOS ELEMENTOS REEMPLAZADOS BAJO GARANTÍA SI LAS PIEZAS NO ESTÁN DISPONIBLES O SON OBSOLETAS.**

1. El comprador original recibe la garantía de que las casetas Lifetime estarán libres de defectos de material o de mano de obra por un período de 10 años a contar desde la fecha de la compra original. La palabra "defectos" se define como imperfecciones que perjudican el uso del producto. Los defectos emergentes de un mal uso, abuso o negligencia invalidarán esta garantía. Esta garantía no cubre defectos debidos a una instalación o alteración incorrecta o a un accidente. Esta garantía no cubre daños causados por vandalismo, oxidación, "actos de la naturaleza" u otros eventos que estén más allá del control del fabricante.
2. Esta garantía es intransferible, y queda expresamente limitada a la reparación o reemplazo de los productos defectuosos. Si el producto se encuentra defectuoso dentro de los términos de esta garantía, Lifetime Products, Inc. reparará o reemplazará las piezas defectuosas sin costo alguno para el comprador. Los gastos de envío hacia y desde la fábrica no están cubiertos, y quedan bajo la responsabilidad del comprador.
3. Esta garantía no cubre raspaduras ni marcas en el producto que pueden resultar de su uso normal. Además, los defectos causados por daños intencionales, negligencia, uso irrazonable o por colgarse de las cabriadas invalidarán esta garantía.
4. La responsabilidad por daños incidentales o consecuentes queda excluida hasta el punto en que lo permita la ley. Si bien se hace el mayor esfuerzo posible para lograr el más alto grado de seguridad en todos nuestros equipos, no puede garantizarse la libertad de cualquier tipo de lesión. El usuario asume todos los riesgos de lesiones emergentes del uso de este producto. Toda nuestra mercadería se vende bajo esta condición, y ningún representante de la compañía puede anular ni cambiar esta política.
5. Este producto no está pensado para el uso institucional ni comercial; Lifetime Products, Inc. no asume ninguna otra responsabilidad en conexión con este producto. El uso institucional o comercial invalidará la garantía.
6. Esta garantía se otorga en reemplazo expreso de toda otra garantía, expresa o implícita, incluidas las garantías de comercialización o adaptación para el uso en la medida permitida por las leyes federales y estatales. Ni Lifetime Products, Inc., ni ninguno de sus representantes asume ninguna otra responsabilidad en conexión con este producto. Esta garantía le otorga derechos legales específicos, y usted puede tener otros derechos que varían de estado a estado.

### **NINGUNA GARANTÍA OFRECIDA POR EL FABRICANTE ES VÁLIDA EN MÉXICO**

#### **TODOS LOS RECLAMOS DE GARANTÍA DEBEN ESTAR ACOMPAÑADOS POR UN RECIBO DE COMPRA**

INFORME POR ESCRITO LOS DEFECTOS EN EL PRODUCTO A:

Por favor, incluya el recibo de compra fechado y fotografías de las piezas dañadas.

Lifetime Products, Inc., PO Box 160010 Clearfield, UT 84016-0010,

o llame al 1.800.225.3865 de lunes a viernes de 0700 hasta 1700 (Hora de las Montañas)

#### **REGISTRE SU PRODUCTO**

Visite nuestra página en Internet [www.lifetime.com](http://www.lifetime.com), o llame al 1.800.225.3865 para registrar su producto hoy.

#### **PARA RECLAMOS DE GARANTÍA INTERNACIONALES:**

Todos los reclamos de garantía deben estar acompañados por un recibo de compra. Informe por escrito todos los reclamos de garantía a su representante regional de ventas. Favor de incluir su recibo de compra fechado y fotografías de las piezas dañadas.

Para identificar el representante de su región, visite [www.lifetime.com/international](http://www.lifetime.com/international)



[www.lifetime.com](http://www.lifetime.com)



## GARANTIE DE FABRICATION LIMITÉE DE 10 ANS

### LE FABRICANT RÉSERVE LE DROIT DE FAIRE DES SUBSTITUTIONS EN CAS DE RECOURS EN GARANTIE SI LES PIÈCES NE SONT PAS DISPONIBLES OR SONT OBSOLÈTES

1. Les abris extérieurs Lifetime® sont garantis à l'acheteur d'origine contre tous défauts de matériau ou de fabrication pendant une durée de dix ans à partir de la date d'achat d'origine. Le mot « défauts » signifie des défauts qui empêchent l'utilisation du produit. Les défauts résultant de mauvais usage, d'abus ou de négligence annulent cette garantie. Cette garantie ne couvre pas les dommages causés par le vandalisme, la rouille, « les calamités naturelles » ou tout autre événement en dehors du contrôle du fabricant.

2. Cette garantie n'est pas transférable et est expressément limitée à la réparation ou au remplacement du produit défectueux. Si le produit est déclaré défectueux selon les termes de cette garantie, Lifetime® Products, Inc. réparera ou remplacera les parties défectueuses gratuitement pour l'acheteur. Les frais d'expéditions aller et retour de l'usine ne sont pas couverts et sont à la charge de l'acheteur. Les frais de main-d'oeuvre et frais associés à l'enlèvement, au montage ou au remplacement de l'abri ou de ses composantes ne sont pas couverts par cette garantie.

3. Cette garantie ne couvre pas les égratignures ou éraillures du produits résultant d'une utilisation normale. Par ailleurs, les défauts résultant de dommages intentionnels, négligence, utilisation abusive ou suspension à partir de l'entretoise annulent cette garantie.

4. Toute responsabilité pour dommages incidents ou conséquents est exclue dans la mesure permise par la loi. Bien que toutes les mesures aient été prises pour intégrer le plus haut degré de sécurité dans l'ensemble du matériel, l'impossibilité de blessure ne peut pas être garantie. L'utilisateur assume tous les risques de blessure résultant de l'utilisation de ce produit. L'ensemble de la marchandise est vendu en vertu de cette condition et aucune personne représentant la société ne peut déroger à cette politique, ni la modifier.

5. Ce produit n'est pas prévu pour l'usage institutionnel ni commercial; Lifetime® Products, Inc. n'assume aucune responsabilité pour tel usage. L'utilisation institutionnelle ou commerciale annulera cette garantie.

6. Cette garantie remplace expressément toutes autres garanties, expresse ou tacites, y compris les garanties de commercialisation ou d'adaptation à un but particulier dans la mesure permise par les lois fédérales et des états. Ni Lifetime® Products, Inc. ni aucun de ses représentants n'assume aucune autre responsabilité concernant ce produit. Cette garantie vous accorde des droits particuliers, et vous aurai peut-être des autres droites qui varient d'un état à l'autre.

#### TOUS LES RECOURS EN GARANTIE DOIVENT ÊTRE ACCOMPAGNÉS DU REÇU DE VENTE.

FAIRE PARVENIR UN RAPPORT PAR ÉCRIT DE DÉFECTUOSITÉ DU PRODUIT A :

Lifetime Products, Inc., PO Box 160010 Clearfield, UT 84016-0010

ou appelez-nous au 1.800.225.3865 lundi à vendredi 0700 - 1700 (HNR)

#### ENREGISTREZ VOTRE ARTICLE À :

[www.lifetime.com](http://www.lifetime.com), ou appelez-nous au 1.800.225.3865 pour enregistrer votre article aujourd'hui.

#### POUR RECOURS EN GARANTIE INTERNATIONAUX:

Tous les recours en garantie doivent être accompagnés du reçu de vente. Faire parvenir un rapport par écrit de défectuosité du produit à votre représentant régional de ventes. Veuillez inclure votre reçu de vente daté et photographies des pièces endommagées. Pour identifier votre représentant régional, visitez [www.lifetime.com/international](http://www.lifetime.com/international)



[www.lifetime.com](http://www.lifetime.com)

**ENHANCE YOUR LIFETIME® PURCHASE BY ADDING ACCESSORIES OR OTHER GREAT PRODUCTS**

*To purchase accessories or other Lifetime® products, visit us at:*

***www.lifetime.com***

*Or call: 1-800-424-3865*

**MEJORE SU COMPRA LIFETIME® Y AÑADA ACCESORIOS U OTROS PRODUCTOS EXCELENTES**

*Para comprar accesorios u otros productos Lifetime® EUA, visítenos en:*

***www.lifetime.com***

*O llame al: 1.800.424.3865*

**AMÉLIOREZ VOTRE ACHAT LIFETIME® EN AJOUTANT DES ACCESSOIRES OU DES AUTRES PRODUITS**

*Pour acheter des accessoires ou des autres produits Lifetime®, rendez-vous une visite à :*

***www.lifetime.com***

*Ou appelez-nous au 1-800-424-3865*



**www.lifetime.com**

