

SNOW BEAST



Owner's Manual

This manual contains important safety instructions for the gasoline engine powered snow blower models: 30SB, 36SB, 45SB

READ SAFETY WARNINGS AND OPERATING INSTRUCTIONS CAREFULLY.
SAVE THIS MANUAL.



Need Help?

Parts, Service
and Technical Assistance call:

1-919-550-3221

www.parts3221.com

www.beastpowerequipment.com

www.help3221.com



**DO NOT RETURN THIS SNOW BLOWER TO THE
STORE!**

When you call the help-line you will need to have the following information:

Date of Purchase: _____

Location of Purchase: _____

Serial # - Snow Blower: _____

*Serial number is located on engine block below the starter.

Snow blower and engine life are extended greatly by performing frequent lubrications, oil changes and regular maintenance. To protect your investment perform routine maintenance.

**Visit our
“BEAST POWER EQUIPMENT”
Youtube channel for videos on
operating instructions and
maintenance Instructions**

Go to:

**[https://www.youtube.com/channel/
UC6v3TI02NFsRfnIhuAxCGPw](https://www.youtube.com/channel/UC6v3TI02NFsRfnIhuAxCGPw)**

Copyright© 2012 by GXi Outdoor Power, LLC. All rights reserved.

No part of this publication can be reproduced or distributed without prior written permission of GXi Outdoor Power, LLC Clayton, NC 27520 USA.

DEK is a registered trademark of GXi Outdoor Power, LLC

GXi Outdoor Power, LLC reserves the right to discontinue or change specifications or design at any time without notice and without incurring any obligation whatsoever.

The information and specifications included in this publication were in effect at the time of approval for printing.



This manual contains important safety instructions for Snow Blowers
READ SAFETY WARNINGS AND OPERATING INSTRUCTIONS CAREFULLY
SAVE THESE INSTRUCTIONS.

This owner's manual is considered a permanent part of the snow blower and should remain with the snow blower if resold.

BEAST SERIES

Check out our other great products at www.HomeDepot.com
or visit our web site at www.beastpowerequipment.com



TURF BEAST

36" & 54" Walk Behind
Finish Mower



Z-BEAST

54" & 62" Zero-Turn
Riding Mower



SNOW BEAST

36" & 45" Snow Blower



BRUSH BEAST

36" Brush Mower



THE BEAST

100" Tow Behind Mower

BRUSH MASTER

Chipper/Shredder
with 2-Way Feed



Contents

Safety Information and Warnings.....	1
Preparation Safety Precautions	2
Operation Safety Precautions	3
Safety Decals.....	5
Product Specifications	6
Control Panel and Snow Blower Components.....	7
Missing Parts Request Form.....	8
Assembly Instructions	9
Operating Instructions	
Starting the Engine.....	13
Operating Instructions.....	14
General Maintenance.....	17
Maintenance Schedule.....	18
Service Adjustments	
Adjusting Augers/Impeller Cable.....	19
Adjust/Check Drive Cable	19
Adjusting Shift Rods.....	19
Adjust/Replacing Drive and Augers/Impeller Belts.....	20
Adjusting Discharge Chute Deflector	21
Changing Friction Wheel.....	21
Replacing Headlight Bulb	21
Storage Instructions	22
Troubleshooting.....	23
Replacement Parts.....	25
Limited Warranty and Service.....	29

About the Snow Beast Manual

Congratulations on the purchase of your new Snow Beast commercial snow blower. We at GXi Outdoor Power are confident that this snow blower will provide excellent performance, outstanding quality, and great durability when operated and maintained as directed in this manual.

1. This manual contains assembly, operating, safety, adjustment, maintenance, and troubleshooting instructions. **BEFORE OPERATING YOUR SNOW BLOWER, CAREFULLY READ THIS MANUAL IN ITS ENTIRITY.**
2. This owner's manual is considered a permanent part of the snow blower. It must be available to all operators and/or person(s) servicing the snow blower. Should the snow blower be resold, this manual must remain with the snow blower.
3. All information, illustrations, and specifications contained in this manual were in effect at the time of the publication. GXi Outdoor Power reserves the right to add, delete or modify specifications and/or designs without notice.
4. If you ever have questions in regards to the operation, maintenance or safety of your snow blower, please contact GXi Parts & Service, LLC at 1-919-550-3221.

Safety Information

Emission Control System Information

The U.S. and California Clean Air Acts

EPA and California regulations require all manufacturers to furnish written instructions describing the operation and maintenance of emission control systems. The following instructions and procedures must be followed in order to keep the emissions from your engine within the emission standards. Maintenance, replacement, or repair of the emission control devices and systems may be performed by any engine repair establishment or individual, using parts that are "certified" to EPA standards.

Safety Label Locations

Safety labels are located on your snow blower to warn you of potential hazards. Read them carefully. If a label comes off or becomes hard to read, contact GXi Parts and Service, LLC for a replacement.

Operator Responsibility

It is the owner's responsibility that all operators and mechanics must be trained and read this manual before operating the snow blower as well as being physically able individuals. They should be instructed about safe operating and mechanical procedures. If they can not read or understand English, it is the owner's responsibility to explain all safety operating instructions. The owner or operator is responsible for accidents or injuries occurring to themselves, other people or property. Potential misfortunate incidents can be prevented by the owner/user.

Snow Blower Inspection

For your safety, inspect the snow blower before each use. Before you begin your inspection, be sure the following conditions are met: the snow blower should be on a level surface, with the ignition switch off, the key removed, and the augers disengaged. Also, disconnect the spark plug wires from the spark plugs and ground them against the engine to prevent inadvertent starting.

Training

1. Read, understand, and follow all instructions on the machine and manual(s) before attempting to assemble and operate.
2. Operator must be familiar with all controls, their operations, and how to stop the engine and disengage the controls quickly.
3. Never allow children to operate this machine.
4. Never allow adults to operate this machine without proper instruction.
5. Exercise caution to avoid slipping or falling, especially when operating the machine in reverse.
6. Keep area of operation clear at all times.



WARNING! Do not use your BEAST snow blower to carry passengers. Keep bystanders, helpers, pets and children at a safe distance from the machine while it is in operation. Inspect the area where the equipment is to be used and remove all objects such as rocks, toys, and wires which can be thrown by the machine causing serious injury or death.



Wear appropriate clothing including hard hat, safety glasses and hearing protection. Long hair, loose clothing or jewelry may get tangled in moving parts.

Preparation—Safety Precautions

1. Inspect the area where the equipment is to be used and remove all objects such as rocks, mats, and wire which can be thrown by the machine causing serious injury or death.
2. Disengage all clutches and shift to neutral before starting the engine.
3. Disengage all control levers before starting the engine.
4. Use extension cords and receptacles as specified by the manufacturer for all units with electric drive motors or electric starting motors.
5. Use a grounded three-wire extension cord when using the electric start option.
6. People, pets, and most importantly children must not be near the area being cleared. Do not operate the snow blower in their presence.
7. Never operate snow blower with damaged guards, shields or covers.
8. All users of the snow blower must be alert and pay attention to safety alerts, symbols, and safety signs.
9. Be sure to inspect snow blower before each use.
10. Check the controls and shields to make sure that they are functioning properly before operating. Do not operate if any are damaged or missing.
11. Never attempt to make any adjustments to the snow blower while it is running.
12. Adjust the collector housing height to clear gravel or crushed rock surfaces.
13. Wear appropriate clothing including hard hat, safety glasses and hearing protection. Long hair, loose clothing or jewelry may get tangled in moving parts.
14. Do not operate without wearing adequate winter clothing. Wear footwear that will improve footing on slippery surfaces.
15. Allow snow blower to adjust to outdoor temperature before starting the engine.

Gasoline and other fuels—Safety Precautions

Use extra care when handling gasoline and other fuels as they are flammable and vapors can explode.

1. Only use gasoline approved containers for storage and keep out of reach from children.
2. Do not fill fuel tank completely full. Overfilling may result in fuel leakage. Leave a reasonable amount of space for fuel to expand.
3. If fuel is spilled, do not start the engine. Move the snow blower away from the area, wipe up the spill thoroughly and wait until fuel vapors have evaporated before starting engine.
4. Keep the nozzle in contact with the rim on the fuel tank or container opening at all times, until refueling is complete. Do not use nozzle lock-open device.
5. Do not fill gasoline containers or equipment inside a vehicle or on a truck/trailer bed.
6. Always place gasoline containers on the ground away from your vehicles prior to filling.
7. Never remove gas cap or add fuel when engine is running or the engine is hot.
8. Avoid prolonged breathing of gasoline vapors.
9. Never refuel or drain the machine indoors.
10. Keep face away from nozzle and gas tank opening.
11. Keep gas and other fuels away from skin and eyes. If fuel is spilled on clothing, change clothing immediately.
12. Never use the mouth to siphon gas.
13. Never refuel the snow blower until all moving parts on the snow blower have stopped.
14. Never smoke when handling fuels and stay away from an open flame where fumes can be ignited by a spark.
15. Gasoline is harmful or fatal if swallowed.



DANGER: GASOLINE IS HIGHLY FLAMMABLE AND EXPLOSIVE. Do not add fuel while the engine is running or is hot. Keep open flames, sparks, and heat away from the fuel and store fuel in containers specifically designed for that purpose. **ADD FUEL OUTDOORS ONLY. IF THE FUEL IS SPILLED, DO NOT START THE ENGINE.** Manually push the snow blower away from the spill and wipe up immediately.

Equipment Operation—Safety Precautions

1. Do not operate the engine in a confined space where dangerous carbon monoxide fumes can collect. Carbon monoxide is odorless, tasteless, and can be fatal.
2. Never operate the snow blower without good visibility or light.
3. Exercise extreme caution when operating on or crossing gravel drives, walks, or roads. Stay alert for hidden hazards or traffic.
4. Never operate the snow blower with defective guards or shields, or without the safety devices securely mounted in place and functioning properly.
5. Be aware of discharge and never direct discharge of material toward people or areas where property damage can occur. Keep children and others away.
6. Do not change the governor settings or over speed the engine.
7. Do not overload the machine capacity by attempting to clear snow at too fast a rate.
8. Always stop the engine when you leave the snow blower, even for a moment.
9. To help reduce fire hazard, keep the engine and the area around the engine free of grass, leaves or any other type of foreign material.
10. Beware of any sharp edges. For safety always wear gloves when performing augers/impeller maintenance activities
11. If lightning is seen or thunder is heard in the operators vicinity, do not operate machine. Instead find shelter, as lightning may cause injury/death.
12. After striking a foreign object, stop the engine, remove the wire from the spark plug, thoroughly inspect the snow blower for any damage, and repair the damage before restarting and operating the snow blower.
13. If machine starts to vibrate or function abnormally, stop the engine immediately and check for cause. Vibration is generally a warning of trouble.
14. Keep hands and feet away from augers/impeller . This product is capable of amputating hands and feet.
15. Be alert and slow down when making turns. Also look left, right, and behind before changing directions and reversing to be sure there is a clear path.
16. Never operate snow blower at high transport speeds on slippery surfaces.
17. Never operate snow blower under the influence of alcohol and drugs.
18. Use care when loading or unloading the machine into a trailer or truck.
19. Use care when approaching blind corners, shrubs, trees, or other objects that may obstruct vision.
20. Always disengage power to augers when not in use or transported.
21. Never listen to music with headphones/earphones while operating the snow blower.
22. Use extreme caution when operating on slopes.
23. Never touch a hot engine or muffler.
24. Use caution when operating on gravel surfaces.
25. Only use attachments and accessories that are approved by BEAST.
26. When starting the engine pull the cord slowly until some resistance is felt before using full force.
27. Always have a good grip on the handles and never run while operating the snow blower.
28. Stop the engine whenever you leave the operating position, before unclogging the augers/impeller or discharge chute, and when making any repairs, adjustments or inspections.
29. When cleaning, repairing or inspecting the snow blower, stop the engine and make certain the augers/impeller and all moving parts have stopped. Disconnect the spark plug wire and keep the wire away from the plug to prevent someone from accidentally starting the engine.

Clearing A Clogged Chute—Safety Precautions

1. SHUT THE ENGINE OFF!
2. Wait at least 10 seconds to be sure the augers have stopped rotating.
3. Always use a cleanout tool and never your hands.
4. Ground the spark plug when clearing if hands get close to the augers/impeller.

GASOLINE IS HIGHLY FLAMMABLE AND EXPLOSIVE. FUEL LEAKS, A LOOSE FUEL TANK, OR A LOOSE FUEL VALVE CAN LEAD TO SEVERE INJURY OR DEATH. DO NOT OPERATE THIS SNOW BLOWER IF ANY COMPONENT OF THE FUEL SYSTEM IS LOOSE OR LEAKS GASOLINE!

IMPORTANT! The snow blower belts are adjusted to ensure the augers/impeller stop turning within five (5) seconds of releasing the impeller control lever. If you are making any belt adjustments whatsoever, for your safety and the safety of others around you, you must ensure the belts are re-adjusted to achieve this design specification.

Before setting up your SNOW BEAST snow blower, disconnect the spark plug wires from the spark plugs and ground them against the engine to prevent inadvertent starting. This step should be taken as a precaution whenever you are working on this machine.

DANGER: Do not bypass, modify, alter or disconnect the safety system. Make sure that the safety interlock system is fully operational each time before operating the machine.

Before attempting to use your snow blower, make sure you are familiar with all of the components and have read the manual.

Need Help?

Parts, Service

www.parts3221.comwww.beastpowerequipment.comwww.help3221.com

Safety Decal Identification

The labels shown below are located on your snow blower to warn you of potential hazards and provide you with important safety information. If these decals become difficult to read or are missing from the snow blower, please contact GXi Parts & Service, LLC at customerservice@gxioutdoorpower.com or www.beastpowerequipment.com for a replacement.

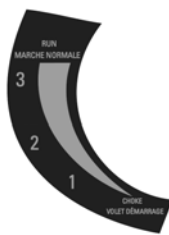
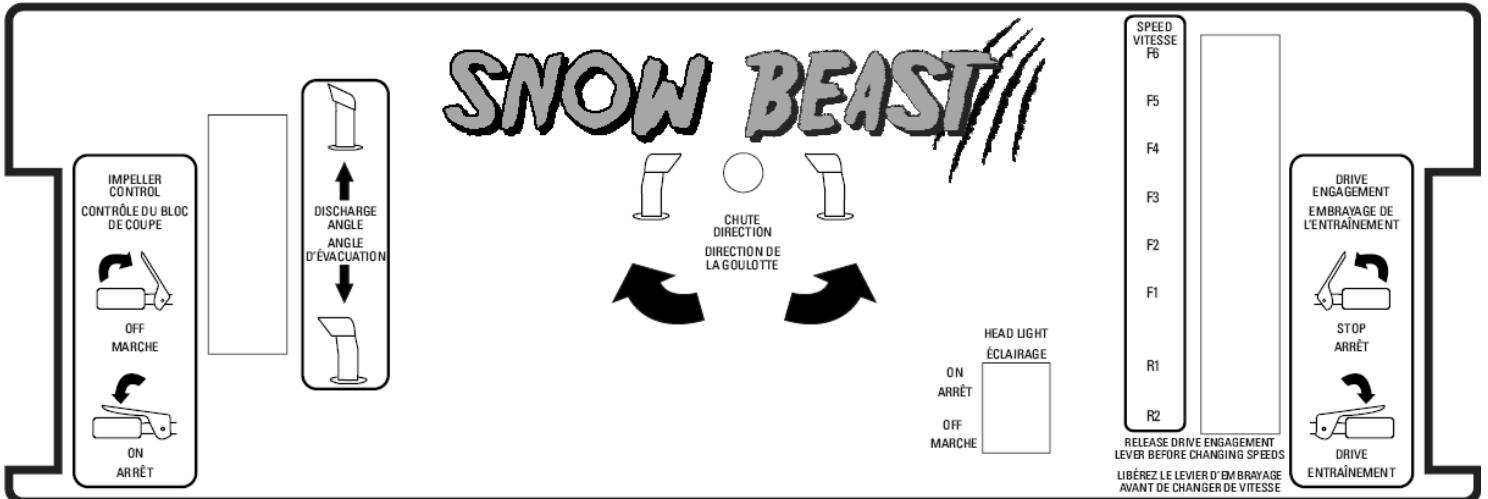

Feature	Models		
	30SB	36SB	45SB
Product Type	Snowblower	Snow blower	Snowblower
Clearing Path	30"	36"	45"
Engine	302cc	420cc	420cc
Torque	15.9 ft.lbs	20.7 ft.lbs	20.7 ft.lbs
Engine Start	120V Electric Start and recoil	120V Electric Start and Recoil	120V Electric Start and Recoil
Speed Control	6 fwd, 2 rev	6 fwd, 2 rev	6 fwd, 2 rev
Deck Type	All Steel	All Steel	All Steel
Discharge distance	40"	40"	40"
Impeller	16" 2 Stage	16" 2 Stage	16" 2 Stage
Auger	16" serrated	16" serrated	16" serrated
Discharge Chute	6"	6"	6"
Fuel/Capacity	Unleaded gasoline/1.32 GAL	Unleaded gasoline/1.32 GAL	Unleaded gasoline/1.32 GAL
Chute control	Crank	Crank	Crank



* Product Specifications may change without notice.

Throughout this manual, instructions are given on the operation of your SNOW BEAST snow blower. We recommend that while going through this manual, you have your snow blower available for quick and easy access in order to orient yourself with the controls, maintenance and orientation of different parts. Please read through the manual before operating.

Control Panel

Below is a diagram of the control panel. Please take the time to familiarize yourself with the snow blower controls.

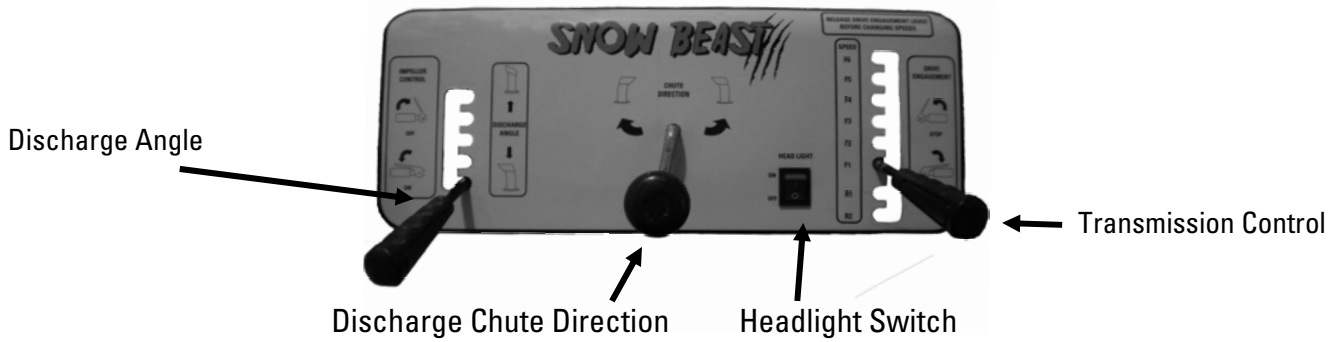

Snow Blower Component Identification

(Some components may appear different than shown, depending on the model.)

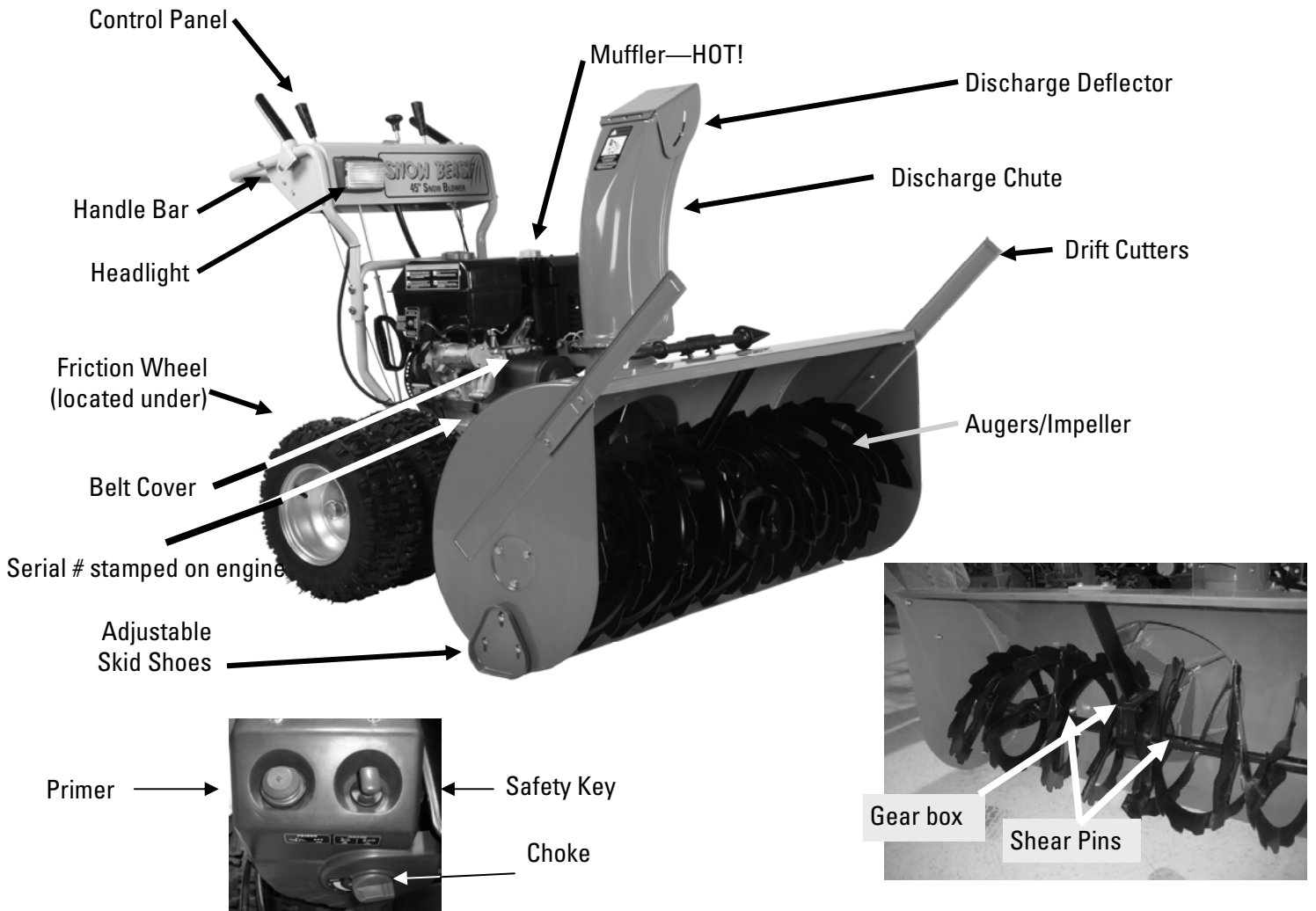

Please indicate the part that you are missing:

- Hardware bag
- Other _____
- Date of purchase _____

Model #: _____

Serial #: _____

Name

Address

Phone

Email

Comments:

IMPORTANT: Please include your receipt. Without a receipt, your order will be delayed. You may also email us at:

customerservice@gxioutdoorpower.com

If emailing, please scan in your proof of purchase.

Please refer to pages 25-28 for a detailed parts listing and description. This will expedite the process of getting parts identified correctly for shipment.

Step 1: Control Panel Handles

1. Align the two holes on each side of the control panel handles over the lower handle frame.
2. Insert the bolts through the handlebar holes and frame holes. Secure in place with hardware provided. All bolt heads must face to the inside.
3. **Connect the headlight wiring harness to the engine Wiring harness.**

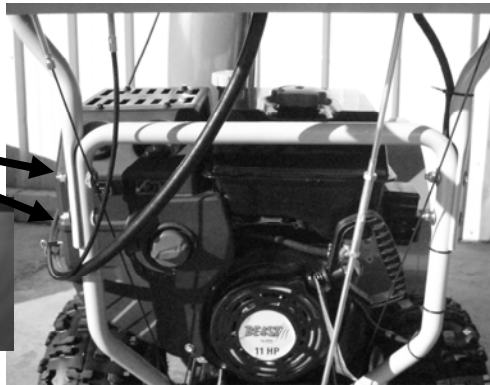

Step 2: Directional Discharge Chute

1. Fit round spacer onto impeller housing before installing chute.
2. Install the bolts for the retainer brackets bottom-up as shown. Insert the plastic spacer between the two metal parts.

DO NOT OVERTIGHTEN. If the bracket is too tight the chute will not move properly. Ensure there is enough space between the impeller housing and the bracket on all sides so that the chute rotates smoothly.

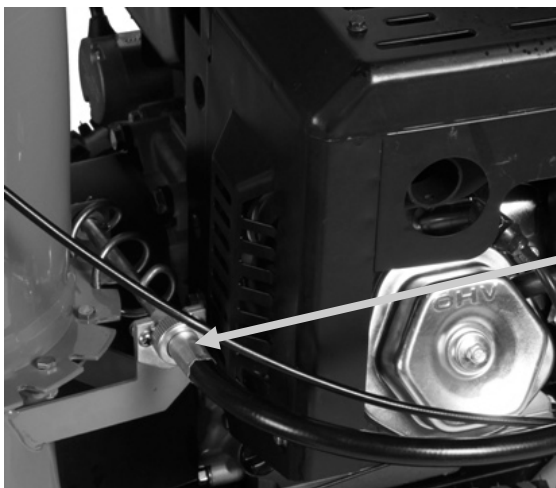
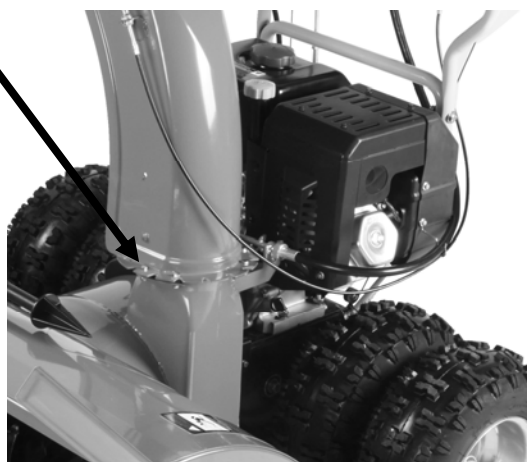
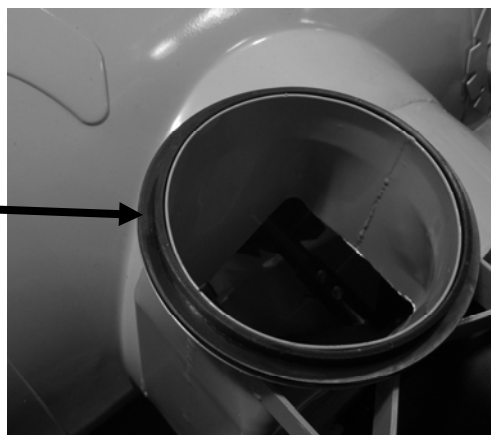
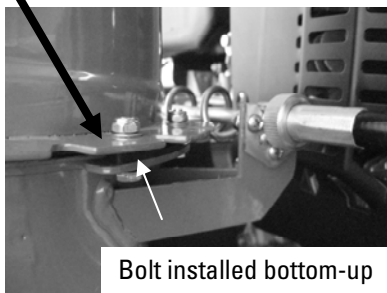

Step 3: Chute Crank

Attach the cable coming from the middle of the control panel by screwing the cable end onto the crank section.

Step 4: Chute Direction Control Cable Support

1. Attach the chute direction control cable hook to the engine cover as shown.
2. Place the chute direction control cable into the support hook, and secure with the zip-ties provided in the hardware bag.

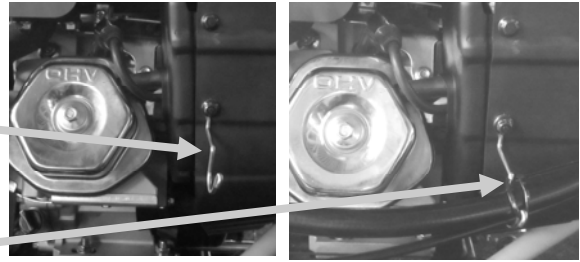

Step 5: Shift Rod

The shift rod is preset at the factory, it connect the shift handle on the control panel to the transmission shift assembly on the chassis.

1. Use the supplied hardware connect the flat end of the shift rod to the transmission shift assembly.
2. Connect the bent end of the shift rod to the shift Handle.

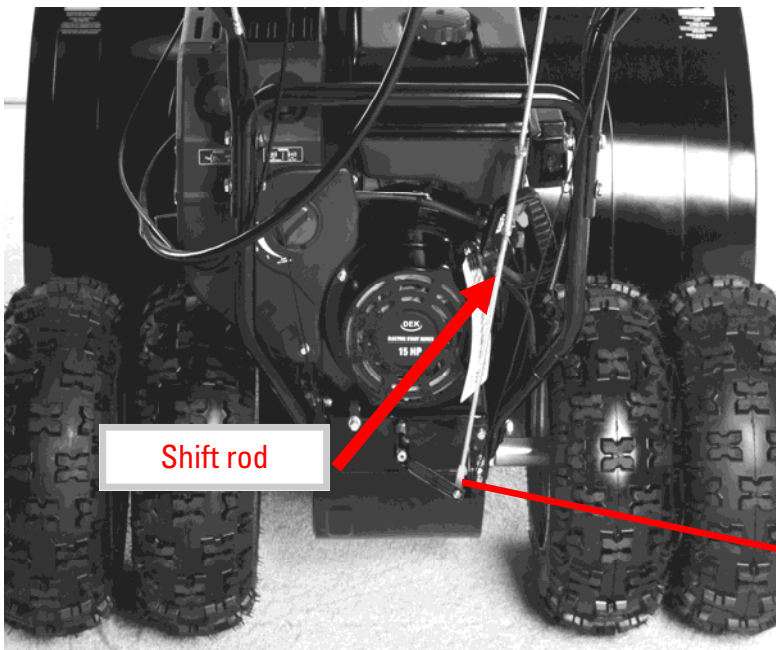
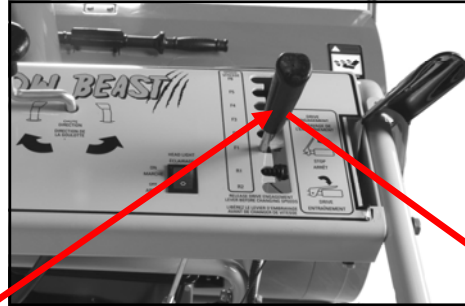

Step 6: Cleanout Tool and Mounting Bracket

1. Insert the mounting bracket bolts into the holes on the top of the auger housing and secure with the M8 nuts.
2. Snap the cleanout tool into the mounting bracket. Snap the cleanout tool

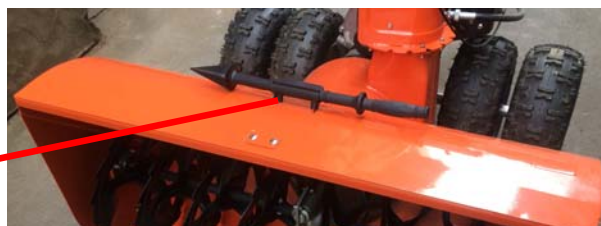

Step 7: Drive Control

1. Locate the thin cable on the right side (standing from the operator position) of the snow blower.
2. Attach the cable to the threaded end under the drive control handle. The cable extension may need to be attached to the bottom of the handle.
3. Screw clockwise to secure. Tighten lock nuts when correct tension is achieved.
4. The drive and impeller cables will be at correct tension when the cables are properly attached to the handles and the cable has a 1 inch deflection to either side when pushed firmly with a finger as shown.

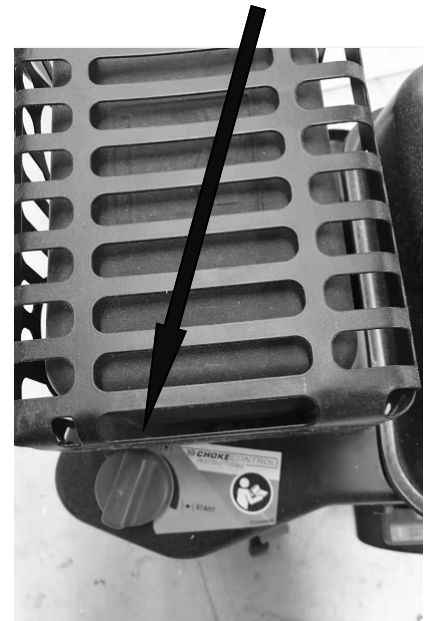

Correct amount of deflection shown

**Step 8: Augers/Impeller Control**

1. Locate the thin cable on the left side of the snow blower.
2. Attach the cable to the threaded end under the impeller control handle.
3. Screw clockwise to secure. Tighten lock nuts when correct tension is achieved.
4. The drive and impeller cables will be at correct tension when the cables are properly attached to the handles and the cable has a 1 inch deflection to either side when pushed firmly with a finger as shown.

Step 9: Drift Cutters (if desired)

1. The drift cutters are attached to the main housing in the stored position.
2. Remove the two bolts on each drift cutter.
3. Reattach the drift cutters in the operating position.
4. Replace bolts and secure tightly.

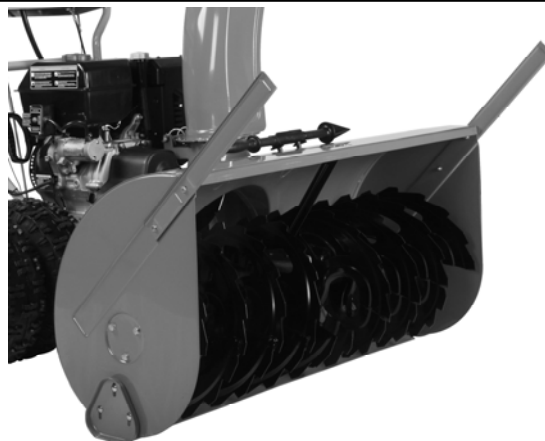
**Step 10: Skid Shoes**

1. Skid shoes are stored in the hardware bag for shipping.
2. Remove from hardware bag, and install skid shoes using the provided fasteners
3. Insert the fasteners so the flat head of the carriage bolt is toward the outside of the main housing.

CAUTION: Check the skids to ensure that the auger does not contact the paved or gravel surface. Adjust skids as necessary to make up for wear on the snow blower.

1. Check the tire pressure to ensure the tires are properly inflated.
 2. Move skid shoes up and down to the desired position based on the surface texture.
 - If the surface is rougher adjust the skid shoes lower.
 - If the surfaces is smoother adjust the skid shoes higher.
- Firmly tighten the nuts that secure both skids to the auger sides.

**Step 11: Headlight**

1. Attach the upper set of handlebars with the control panel mounted.
2. Connect the headlight cable to the plastic connector that is coming from the snow blower.



DANGER: GASOLINE IS HIGHLY FLAMMABLE AND EXPLOSIVE. Do not add fuel while the engine is running or is hot. Keep open flames, sparks, and heat away from the fuel and store fuel in containers specifically designed for that purpose. **ADD FUEL OUTDOORS ONLY. IF THE FUEL IS SPILLED, DO NOT START THE ENGINE.** Manually push the snow blower away from the spill and wipe up immediately.

Step 12: Filling Oil and Gasoline

1. Fill the engine with SAE 5W-30 engine oil. Fill the engine with 1.2 to 1.5 quarts of oil. Fill up to the full level mark on the dip stick.
2. Check that the fuel filter is clean and fill the tank with unleaded gasoline.



Before attempting to use your snow blower, make sure you are familiar with all of the components and have read the manual.

DANGER: Exhaust contains poisonous carbon monoxide, a colorless and odorless gas. Breathing exhaust can cause loss of consciousness and may lead to death. Do not operate the engine in a confined space where dangerous carbon monoxide fumes can collect.



Thoroughly inspect the area where you plan to use the snow blower. Look for items such as stones, sticks, wire, and other foreign objects. If struck by the snow blower, these and other objects may become projectiles that could lead to serious injury or death. Clear area of all debris. Keep people and pets at a safe distance.

Starting the Engine Using the Recoil Start

NOTE: Be sure to add fresh unleaded gasoline and fill the engine with SAE5-W30 motor oil (1.2—1.5 quarts) before starting your snow blower.

1. Make sure the safety key is fully inserted in order for the engine to start. Remove the key when the snow blower is not in use.
2. Firmly push the primer to force the fuel directly into the engine’s carburetor. Push two to four times depending on the temperature. Note: Do not press the primer button more than 7 times. Fuel may leak from the carburetor with over priming.
3. Make sure the choke is set in the CHOKE position (choke more in colder temperatures).
4. Pull the recoil to start the engine.
5. After the engine is started, slowly turn the choke up one level at a time as the engine warms up until it is at the maximum level or “RUN LEVEL.”



WARNING! The electric starter is designed to operate on 120 volt AC household current. Use only a UL-listed, 16 gauge extension cord for outdoor use that is no longer than 50 feet (15 meters).

To prevent damaging electric starter wait 1 minute between every electric start attempt and never use electric start in the rain.

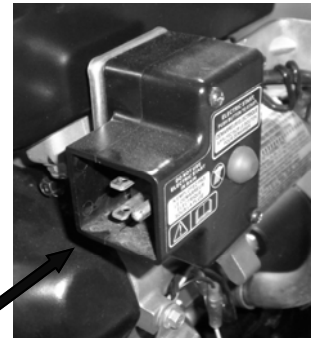

Starting the Engine using the Electric Start

1. Use a safe, non damaged power cord to plug into the electric start outlet.
2. Make sure the safety key is fully inserted in order for the engine to start. Remove the key when the snow blower is not in use.
3. Firmly push the primer to force the fuel directly into the engine’s carburetor. Push two to four times depending on the temperature.
4. Make sure the choke is set in the CHOKE position (choke more in colder temperatures).
5. Press the electric start button. Note: Do not engage starter more than 10 seconds each time.
6. After the engine is started, slowly turn the choke up one level at a time as the engine warms up until it is at the maximum level or “RUN LEVEL.”
7. Unplug the extension cord before operating the snow blower.

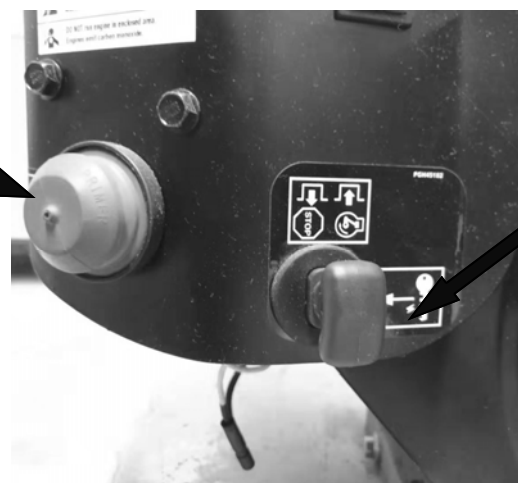

Safety Key

Transmission Control

Your snow blower is equipped with an easily adjustable transmission control, which can be adjusted for forward and reverse speed.

There are six forward and two reverse speeds.

To change the speed, pull the handle out to the right and move the handle to the desired speed.



WARNING

DO NOT shift gears while the transmission is engaged. Come to a complete stop and disengage the transmission handle before switching speed or switching from forward to reverse.

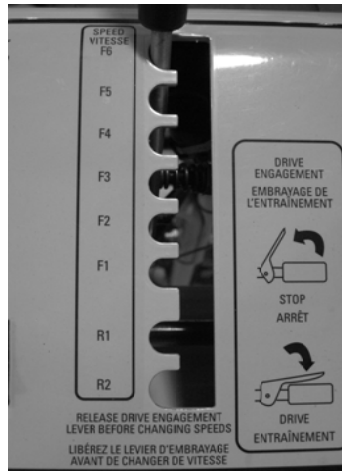

Engage Transmission Drive

To engage the transmission drive squeeze the right lever to the hand grip.

To disengage, let go of the right lever.



To Stop Engine

To stop the engine, pull the safety key up until the engine and augers/impeller stops running. For safety, it is recommended that you remove the key when not using the snow blower.

Engage Augers/Impeller Control

To engage the augers/impeller drive squeeze the left lever to the handgrip.

To disengage release the left lever.

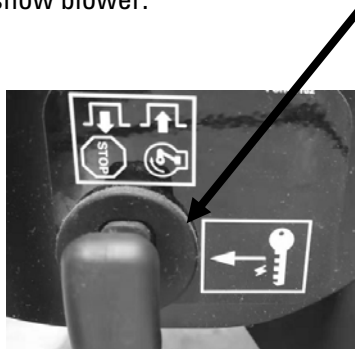

WARNING



WARNING! Do not operate the snow blower with defective guards, shields, or without the safety devices securely in place.

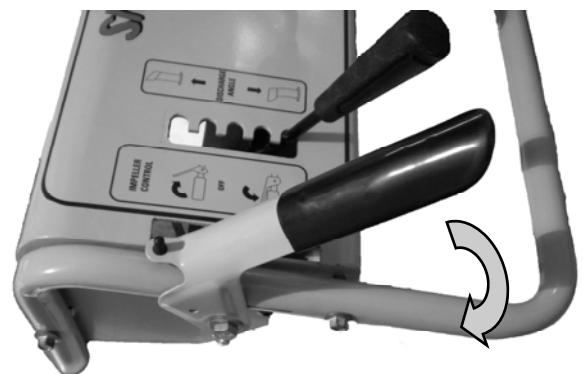

IMPORTANT! The snow blower belts are adjusted to ensure the augers stop turning within five (5) seconds of releasing the impeller control lever. If you are making any belt adjustments whatsoever, for your safety and the safety of others around you, you must ensure the belts are re-adjusted to achieve this design specification.

Chute Direction Control

To rotate the chute to the right rotate the chute control clockwise.

To rotate the chute to the left rotate the chute control counter-clockwise.

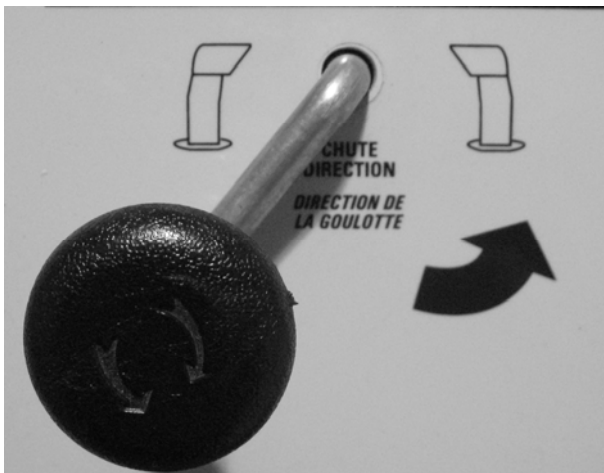

Headlights

To turn on the lights, flip the switch up.

To turn off the lights, flip the switch down.

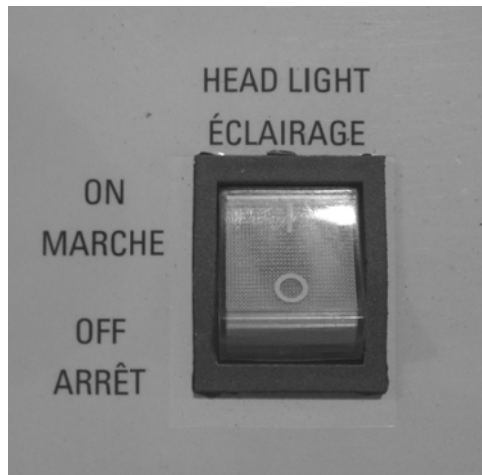

Never use your hands to clean a clogged chute or opening.

Chute Discharge Angle

There are five different angles the discharge chute can be arranged to discharge.

To change the discharge angle, pull the handle out to the left and move to the slot up to discharge snow at a higher angle and down to discharge snow at a lower angle.

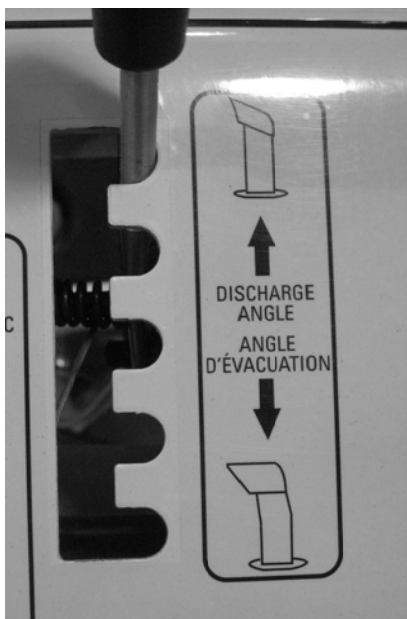

Clean Out Tool

Release both wheel and impeller drives. Stop the engine by removing the safety key. Wait for all moving parts to stop. Use clean out tool as needed.



DANGER! Make certain the engine comes to a complete stop before putting you hands near the augers/impeller .

Using your Snow Beast.

The following tips will help ensure proper and long lasting use of your BEAST snow blower. ALWAYS wear proper safety equipment when operating the snow-blower, and make sure you dress appropriately for cold weather.

Figure 1

- Before use, always ensure there is nothing lodged in the auger, or impeller area. Inspect the auger and impeller for damage from rocks or other debris, and ensure there is no string, twine, etc stuck on the auger or impeller shafts. Visually inspect for loose hardware or any control cables that are loose or disconnected. Ensure the sheer-pins are intact before operation.
- Inspect the area you will be operating the snow blower in. Avoid areas with rocks, large branches and limbs, or other debris that may damage the snow-blower. Only operate the snow blower on paved ground.

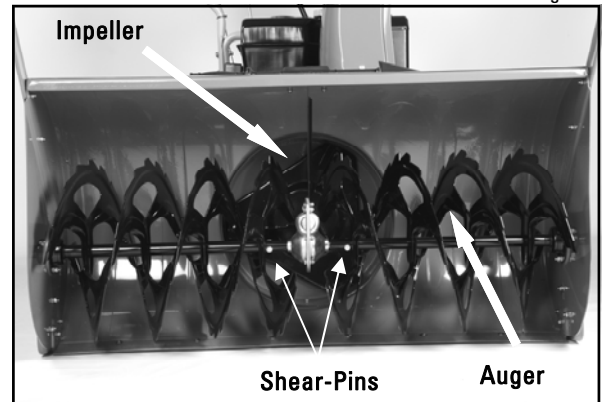

Figure 1

Figure 2

- To pro-long the life of the friction wheel system, do not partially-engage the drive system, or continually engage and dis-engage the drive system if the engine begins to slow under heavy loads. When operating the snow-blower in dense wet snow, or significant amounts of snow, use a slower speed on the transmission.



Figure 2

Figure 3

- The Snow Beast uses a “live axle” which means the wheels on either side of the snow blower turn together. When turning the snow-blower 180° dis-engage the drive system. Shift to Speed 1. Re-engage the drive handle and pull on the control handle to shift the weight distribution to the outside tire. This will assist in turning the snow blower, and is especially important for the 45SB which uses double tires on each side.
 - ⇒ Example: If turning left, shift the weight of the snow blower to the right. If turning right, shift the weight of the snow blower to the left.

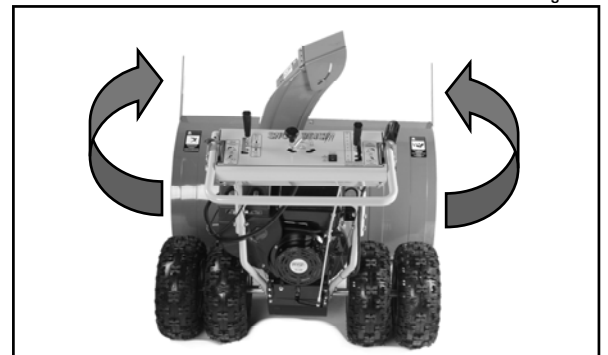

Figure 3

Figure 4

- Set the desired dis-charge direction and angle before engaging the auger/impeller. Do not adjust the discharge direction or angle while throwing snow. The extra forces may damage the cables.

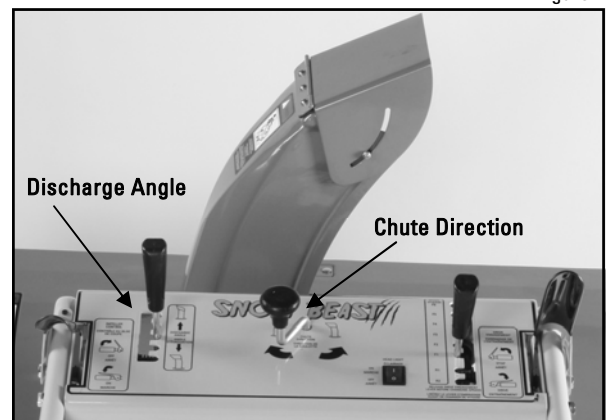

Figure 4

The Importance of Maintenance

Regular maintenance is essential to ensure your snow blower continues to deliver safe and high-quality performance.

To help you properly care for your snow blower, the following pages include a recommended maintenance schedule, routine inspection procedures, and simple maintenance procedures using basic hand tools. Maintenance is the responsibility of the owner and must be performed regularly. More difficult service tasks or tasks that require special tools are best handled by a recommended service technician or other qualified mechanic.

The maintenance schedule described on page **19** applies to snow blower used under normal operating conditions. If you operate your snow blower under severe conditions, such as sustained prolonged use or use it in unusually wet, dusty or rocky conditions, consult your servicing dealer for recommendations applicable to your individual needs and use.

Be sure to use genuine SNOW BEAST replacement parts when servicing your snow blower to assure the best quality, safety and performance.

Need Help? Parts, Service and Technical Assistance
1-919-550-3221 ext. 158

Check Skid Shoes

Check the skids to ensure that the auger does not contact the paved or gravel surface.

Adjust skids as necessary to make up for wear on the snow blower.

Replacement skid shoes are available for purchase through GXi Parts & Service.

Part# B07111

www.parts3221.com

Check Oil Level

CHECK ENGINE OIL BEFORE EACH USE. Change oil as recommended on page 19 and follow proper procedures to check and change oil.



CAUTION! Before making any adjustments and/or servicing to your SNOW BEAST, make sure the snow blower is on a level surface, with the ignition switch off, the key removed, and the augers disengaged. Also, disconnect the spark plug wires from the spark plugs and ground them against the engine to prevent inadvertent starting.

If you are performing adjustments or maintenance after operating the snow blower, allow the unit to cool and always wear protective clothing.



CAUTION: Always wear work gloves when performing auger maintenance and beware of sharp edges. Be sure the engine is off, the key removed, and the spark plug wires are disconnected from the spark plugs to prevent inadvertent starting.

Shear Bolts

Check shear bolts (as well as other bolts) at frequent intervals for proper tightness to be sure the equipment is in safe working condition.

Do NOT use standard bolts to replace shear bolts.

Severe damage or injury could occur. Warranty is also void if shear bolts are not used.

Shear bolts are available for replacement through GXi Parts & Service.

Part# B06711

www.parts3221.com

After Blowing Snow

Allow the machine to run with the impeller engaged for a few minutes after blowing snow to prevent freeze-up of the augers/impeller.

Item	Procedure	Time Interval				
		Break-in (first 5 hrs)	Before each use (daily)	Every 40 hrs (weekly)	Every 100 hrs (Bi-weekly)	Every 200 hrs (monthly)
Belts	Inspect Tension (adjust if needed)	X	X			
Augers/Impeller	Inspect		X			
Engine Air Filter	Inspect			X		
Engine Oil	Check		X			
	Change			20-30 hrs		
Engine Spark Plug	Inspect			20-30 hrs		
Fuel Line	Check				X	
Hardware	Check for proper tightness	X	X	X	X	X
Snow Blower Main Frame	Remove debris from under belt cover	X				
Safety Interlock System	Check Operations and Switches		X			
Tires	Check Air Pressure		X	X		
Augers/Impeller Brake			X			

Cleaning the Snow blower

It is recommended that the SNOW BEAST snow blower be cleaned on a daily basis. Excessive accumulation of dirt, debris, oil, etc. on the muffler, air filter, snow blower augers/impeller and engine may present a potential safety hazard.

Adjusting Augers/Impeller Cable

If tension seems to be too loose or too tight the augers/impeller cables needs to be readjusted.

1. Loosen the bolt above where the cable screws in to the left side of the control panel.
2. Loosening the bolt enables the cable to screw in further, which makes the augers/impeller handle tighter.
3. Adjust the bolt and cable to the necessary adjustments.



Adjusting Drive Cable

If tension seems to be too loose or too tight the drive cables needs to be readjusted.

1. Loosen the bolt above where the cable screws in to the right side of the control panel.
2. Loosening the bolt enables the cable to screw in further, which makes the augers/impeller handle tighter.
3. Adjust the bolt and cable to the necessary adjustments.



Adjusting Shift Rod

The shift rod will be at a preset position from the factory, but after use, or maintenance, the shift rod may require occasional adjustment.

Signs of adjustment need:

1. The shift handle is moved to the F1 position, and when the engagement handle is pressed, the unit does not move.
2. The shift handle is moved to the R1 position, and when the engagement handle is pressed, the unit does not move.

If either of the above occur, it may be necessary to adjust using the following procedure:

1. Set the transmission handle to the space between F1 and R1 as shown on the right.
2. Loosen the 2 nuts on the adjustment turnbuckle.
3. Remove the cover plate from the gearbox housing (see page 21).
4. Adjust the rod by turning the turnbuckle until the friction wheel aligns with the center of the circular disk in front of the rubber friction wheel.

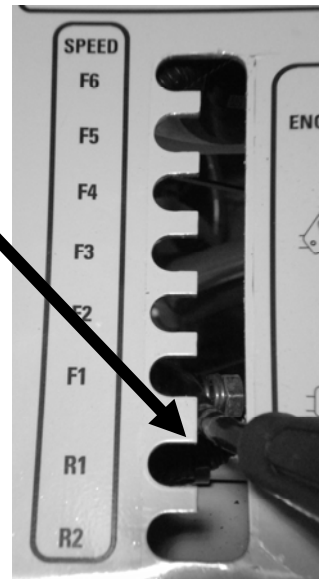

Check & Replacing the Transmission Drive Belt

If belt needs to be changed or altered for any reason, the belt is located in the front of the snow blower behind the discharge chute and in front of the wheels.

1. Remove the cover that is protecting the snow blower's belts. Remove the screws and simply lift up the cover.
2. Remove the black belt and replace with a new belt.
3. Attach the cover and all hardware as they were when taken off.

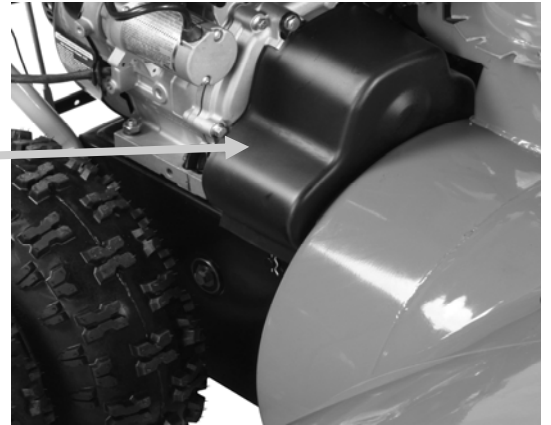

Check & Replacing the Augers/Impeller Belt

There are two located in the front of the snow blower behind the discharge chute and in front of the wheels.

1. Remove the cover that is protecting the Snow Beast's belts. Remove the screws and simply lift up the cover.
2. Remove the two belts and replace with new belt or belts depending on the belt's condition.
3. Attach the cover and all parts as they were when taken off.

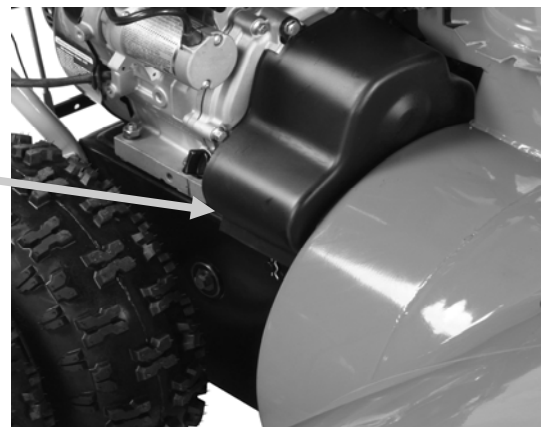

NOTE: Always change both belts at the same time. Changing only one belt can lead to performance issues. Also check for correct belt tension after changing belts. Readjust if necessary.
 Belt Spec: MXV4-370
 Part# B08911

IMPORTANT! The snow blower belts are adjusted to ensure the augers stop turning within 5 seconds of releasing the augers/impeller control lever. If you are making any belt adjustments whatsoever, for your safety and the safety of others around you, you must ensure the belts are re-adjusted to achieve this design specification.

Adjusting Discharge Deflector

The discharge chute is preset at the factory, but may require adjustment over time or during maintenance. For adjustments, follow the procedure below:

1. Loosen the two nuts at the chute cable mount on the discharge chute.
2. To make the chute open more, adjust nuts so the cable end moves closer to the discharge deflector (upward).
3. To make the chute close more, adjust nuts so the cable end moves further from the discharge deflector (downward).

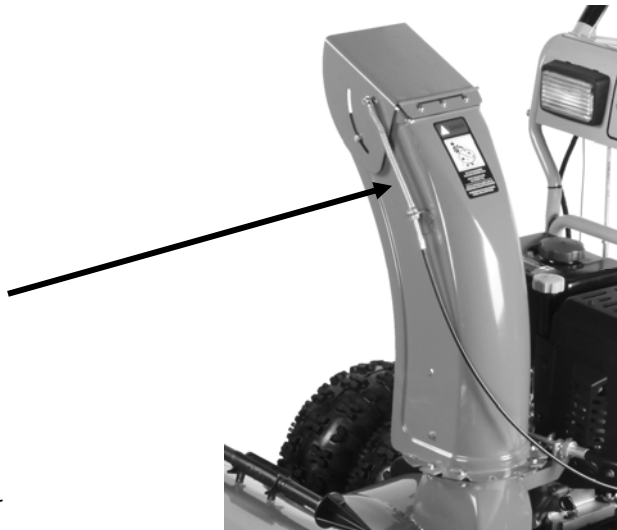

Changing Friction Wheel

If the friction wheel needs to be replaced for any reason:

1. Remove the two bolts to remove the cover underneath the control panel between the wheels.
2. Remove the bolt and nut in the hexagonal shaft carrying the friction wheel
3. With the bolt and locking nut removed, the shaft can be removed with the rubber friction wheel assembly.
4. Replace the friction wheel and reassemble in reverse order.
5. Resetting the neutral position may be necessary.



Replacement friction wheel rubber is available for purchase through GXi Parts & Service
 Part# B05311
www.parts3221.com

Replacing Headlight Bulb

1. Push the headlight case up from the bottom, then gently lift the headlight out.
2. Twist the black round wire harness counter-clockwise until the bulb is unlocked at the spot.
3. Replace the bulb and lock the headlight back into place the same way it was taken out.



Replacement bulbs are available for purchase through GXI Parts & Service.
 Part# B03211

Short Term Storage

- Let engine cool before storing and do not store near flame, high heat, and possible ignitions from sparks.
- Always clean off all flammable material as well as grime and dirt before storage.
- Wash with mild detergent and water only.
- After washing the machine engage the engine at high and let the snow blower run for 5 minutes.
- Store snow blower only on the ground.
- Do not drain fuel indoors or near a flame.
- Always park machine on level ground.
- Store the machine in a clean and dry environment.
- Always remove the safety key and ground the spark plug to the engine.
- Always run the snow blower before storage to clear up snow to prevent freeze up.
- Check all parts to see if they are in working condition.

Extended Storage

- Change air filter.
- Make sure all fuel is drained before storing.
- To ensure all fuel is drained from the snow blower, turn the fuel valve off, then run the snow blower until it runs out of gas before storage.
- Add a fuel stabilizer to fresh fuel on the last refueling day.
- Check the spark plugs condition and pour two tablespoons of engine oil in the spark plug holes and leave the spark plugs off.
- Cover the machine when in storage.
- Everything mentioned in short term storage should also be applied to extended storage.

Problem	Possible Causes	Solution
Engine will not start	<ol style="list-style-type: none"> 1. Key in the OFF position 2. Insufficient fuel in the tank 3. Air bubble in the fuel line 4. Fuel valve in OFF position 5. Choke not ON 6. Choke linkage out of adjustment 7. Loose spark plug wire 8. Fouled spark plug 9. Plugged or dirty air filter 10. Bad gasoline 	<ol style="list-style-type: none"> 1. Turn key to ON position 2. Add gasoline 3. Prime engine or shake bubble out 4. Turn valve ON 5. Turn choke ON 6. Refer to Engine Owner’s Manual 7. Add engine oil 8. Tighten wire or connections 9. Clean or replace the plug 10. Clean or replace the air filter 11. Drain and replace with fresh gasoline
Fuel is leaking from the engine.	<ol style="list-style-type: none"> 1. Primer button was pressed too many times. 2. Fuel hose has become dis-connected 3. Carburetor has contaminants in it causing the bowl to flood. 	<ol style="list-style-type: none"> 1. Do not press primer more than 3 times. Wipe off excess fuel and allow to dry COMPLETELY before attempting to start 2. Re-connect fuel hose and clamp(s) 3. Fuel tank and carburetor needs to be flushed and carburetor needs cleaning.
Engine will not start with electric starter	<ol style="list-style-type: none"> 1. Not using proper gauge cord 2. Safety key is loose 	<ol style="list-style-type: none"> 1. Use 120V 16 gauge cord in good condition. 2. Verify the safety key is fully inserted.
Engine will not keep running/quits	<ol style="list-style-type: none"> 1. Water in the fuel 2. Fuel valve is OFF 3. Low engine oil 	<ol style="list-style-type: none"> 1. Drain and replace with fresh fuel 2. Turn fuel valve ON 3. Add engine oil
Augers do not turn	<ol style="list-style-type: none"> 1. Shear pins holding the augers may have sheared. 	<ol style="list-style-type: none"> 2. If the pins sheared, replace them as needed after applying lubricant into the shaft. Call GXi Parts & Service at 1-919-550-3221 or email: customerservice@gxioutdoorpower.com for parts.
Shaft is not turning	<ol style="list-style-type: none"> 1. Shear-Pins holding the augers may have sheared. 2. Check the gearbox. 	<p>If the pins sheared, replace them as needed after applying lubricant into the shaft. Call GXi Parts & Service at 1-919-550-3221 or email: customerservice@gxioutdoorpower.com for parts.</p>
Snow blower always pulls to one side	<ol style="list-style-type: none"> 1. Skid shoes and / or scrapper blade dragging more on one side than the other 	<ol style="list-style-type: none"> 1. Adjust skid shoes and / or scrapper blade so the scrapper blade drags uniformly on the surface being blown.

Problem	Possible Causes	Solution
Snow blower will not move forward or reverse	1. Transmission cable out of adjustment (too loose) or damaged.	1. Readjust transmission cable If damaged, replace and readjust.
Cannot move snow blower when the engine is off	1. Transmission handle is pressed into the engaged position 2. Transmission cable out of adjustment (too tight)	1. Release transmission handle 2. Readjust transmission cable
Engine is overheating	1. Dirt in the fuel line 2. Dirty air filter 3. Low engine oil 4. Fouled spark plug 5. Misuse of the snow blower	1. Replace fuel filter and flush tank 2. Clean or replace the air filter 3. Add engine oil 4. Replace spark plug 5. Walk the snow blower slowly

Collector Housing Assembly Reference

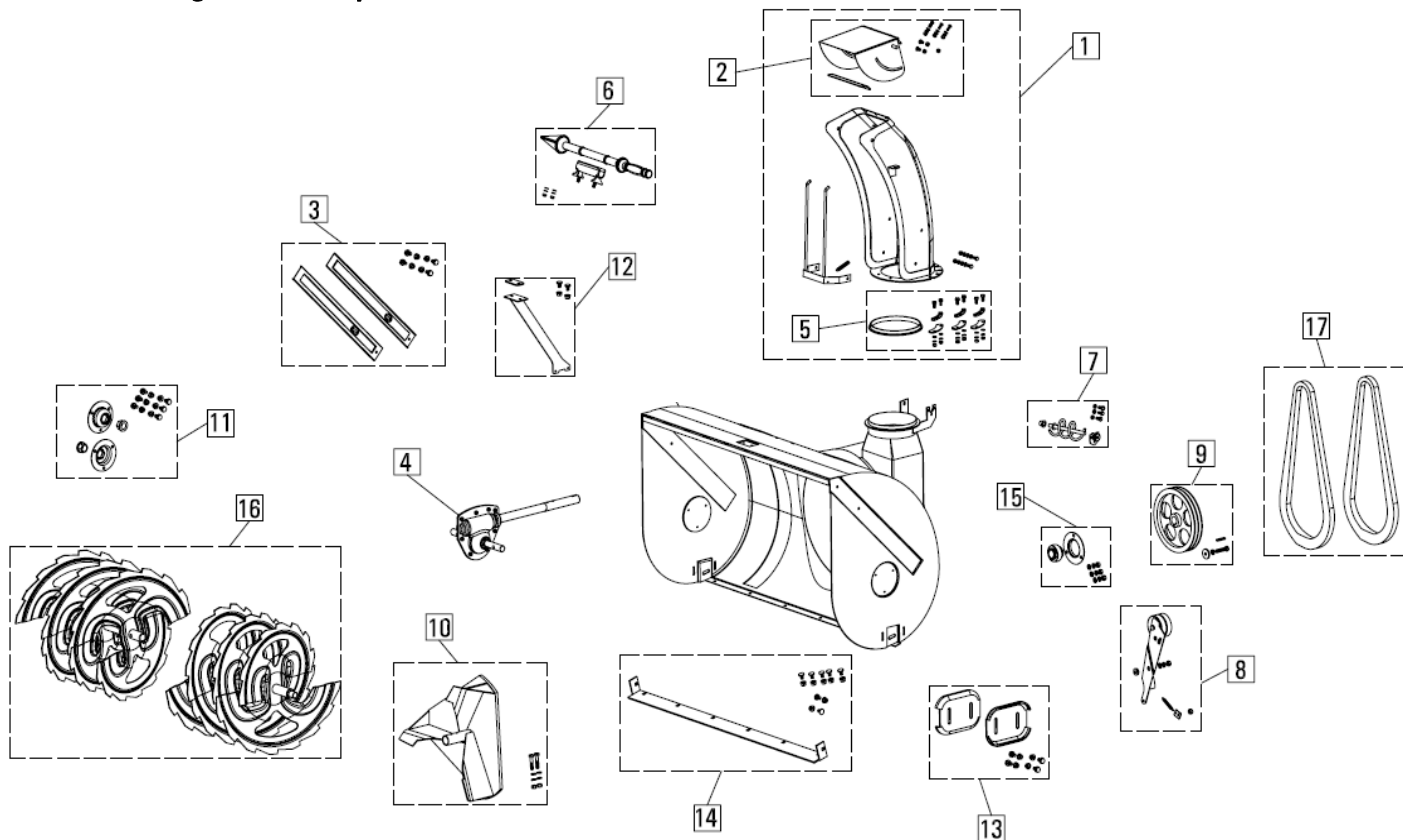

Item #	GXi Part#	Description
1	B00510	Discharge Chute Assembly—Orange
2	B00710	Discharge Chute Deflector—Orange
3	B00910	Drift Cutters—Orange (Set of 2)
4	B01410	Auger/Impeller Gearbox
5	B01510	Discharge Chute Rotation Bushing with Clamps
6	B02410	Snow Cleanout Tool with Bracket and Hardware
7	B03711	Discharge Chute Direction Gear (Spiral Gear) with Bracket
8	B04811	Auger/Impeller Clutch Pulley Assembly & Bracket
9	B05111	Auger/Impeller Pulley (Mounts to Impeller Shaft)
10	B06511	Impeller
11	B06811	Auger Shaft Bearings with Flange
12	B06911	Gearbox Support bar
13	B07111	Skid Shoes—Orange (Set of 2)
14	B07211	Scraper Blade Assembly
15	B08211	Impeller shaft Bearing Support with Bracket
16	B08311	Auger/Collector Assembly
17	B08911	MXV4-370 Aramid Fiber Re-Enforced V-Belts (Set of 2)

Chassis Assembly Reference

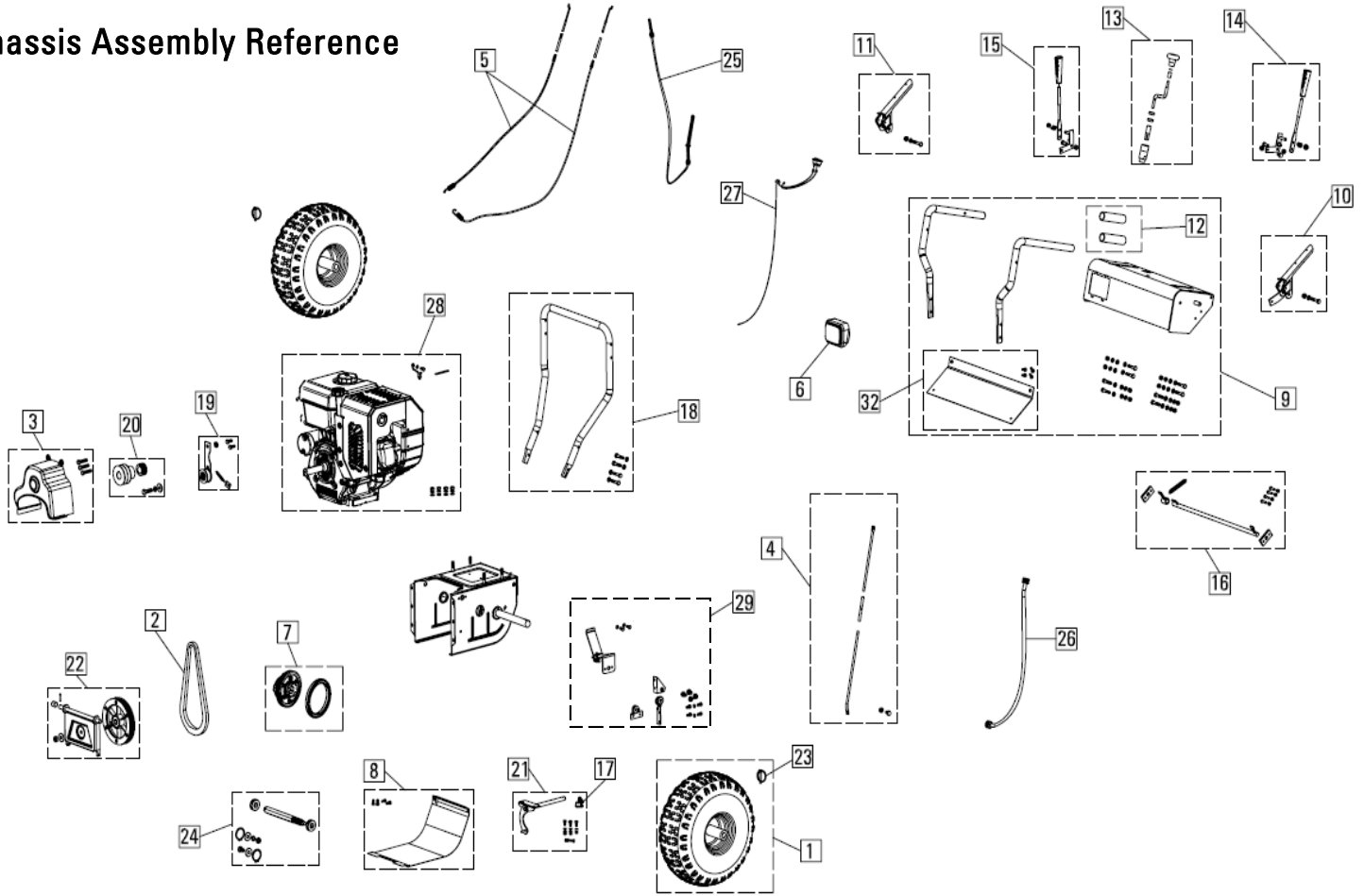

Item #	GXi Part Number	Description
1	B00110	Snow blower Wheel and Tire Assembly. Includes lynch pin. Models: 30SB, 30SS, 36SB, 36SS, 45SB, 45SS
2	B01110	Transmission Belt (toothed belt) Models: 30SB, 30SS, 36SB, 36SS, 45SB, 45SS
3	B01310	Plastic Belt Guard for 420cc Snow blower Engine. Models: 30SB, 30SS, 36SB, 36SS, 45SB, 45SS
4	B01910	Shift Rod. Attaches from the shift lever to the friction wheel pivot bar. Includes hardware. Models: 30SB, 30SS, 36SB, 36SS, 45SB, 45SS
5	B02010	Augers/Impeller OR Drive Engagement cable for snow blowers. Contains 1 cable and cable end for auger/impeller or drive engagement. Models: 30SB, 30SS, 36SB, 36SS, 45SB, 45SS
6	B02210	Headlight Assembly (Black bezel, plastic housing, bulb, and wires). Models: 30SB, 30SS, 36SB, 36SS, 45SB, 45SS
7	B02510	Friction Wheel Assembly with Bearing (Complete friction wheel with bearing and friction rubber pre-installed. Models: 30SB, 30SS, 36SB, 36SS, 45SB, 45SS
8	B02610	Friction Wheel Cover Panel with hardware. Models: 30SB, 30SS, 36SB, 36SS, 45SB, 45SS
9	B09011	Upper Control Handle/Control Panel Frame ONLY - GREY. Includes labels, and rubber grips and hardware to attach to lower control handle. Does not include control handles, crank handles, or electrical wiring. Models 30SB, 36SB, 45SB
10	B02811	Left Control Handle. Includes rubber grip and hardware. - GREY. Models: 30SB, 36SB, 45SB
11	B02911	Right Control Handle. Includes rubber grip and hardware. - GREY. Models: 30SB, 36SB, 45SB
12	B03411	Handle Rubber Grip for 2010+ BEAST Snow blowers. Models: 30SB, 36SB, 45SB
13	B03511	Chute Direction Control Handle. Includes crank handle, rubber knob, square cable receiver, and bearings. Models: 30SB, 30SS, 36SB, 36SS, 45SB, 45SS
14	B03811	Discharge Chute Angle Lever (Left Lever). Includes rubber grip and hardware. Models: 30SB, 30SS, 36SB, 36SS, 45SB, 45SS
15	B03911	Transmission Speed Shift Lever (Right Lever). Includes rubber grip and mounting hardware. Models: 30SB, 30SS, 36SB, 36SS, 45SB, 45SS

Item #	GXi Part Number	Description
16	B04411	Control Handle Inter Lock Linkage. Includes rod, tab, 2 springs, and end connections. (Linkage rod that runs from the left control handle to the right control handle). Models: 30SB, 30SS, 36SB, 36SS, 45SB, 45SS
17	B04511	Outer Friction Wheel Shift Linkage with hardware. Models: 30SB, 30SS, 36SB, 36SS, 45SB, 45SS
18	B04711	Lower Handle Bar Frame - GREY. (Attaches from the frame to the upper control panel assembly.) Includes hardware to attach to upper control handle and chassis. Models: 30SB, 36SB, 45SB
19	B04911	Transmission Belt Idle Pulley with Bracket. (Includes idle pulley, mounting bracket, and return spring) Models: 30SB, 30SS, 36SB, 36SS, 45SB, 45SS
20	B05011	Crankshaft Pulley Set (Includes auger/impeller double pulley, transmission toothed pulley, spacer bushing, axle keys and bolt with washer.) Models: 30SB, 30SS, 36SB, 36SS, 45SB, 45SS
21	B05611	Friction Wheel Shift Linkage Assembly Includes outer friction wheel shift linkage, inner friction wheel shift linkage, and bracket with hardware. Models: 30SB, 30SS, 36SB, 36SS, 45SB, 45SS
22	B09311	Friction Wheel Aluminum Drive Hub Assembly. Models: 30SB, 30SS, 36SB, 36SS, 45SB, 45SS
23	B09411	Snow blower Wheel lynch pin. Models: 30SB, 30SS, 36SB, 36SS, 45SB, 45SS
24	B09711	Intermediate Axle Shaft with bearings, and snap rings. (Friction wheel rotates on intermediate shaft). Models: 30SB, 30SS, 36SB, 36SS, 45SB, 45SS
25	B02110	Discharge Chute Deflector Cable. Includes spring, spring guide and hardware. Models: 30SB, 30SS, 36SB, 36SS, 45SB, 45SS
26	B01810	Chute Direction Control Cable. Models: 30SB, 30SS, 36SB, 36SS, 45SB, 45SS
27	B00410	Headlight Switch and Wiring harness. Models: 30SB, 30SS, 36SB, 36SS, 45SB, 45SS
28	E07610	Engine Assembly - 420cc Electric Start (Includes complete ready to run engine assembly with fuel tank and recoil. Does NOT include crankshaft pulleys.) Models: 36SB, 36SS, 45SB, 45SS
29	B10611	Auger and Impeller Guide Pulley Assembly.

To order replacement parts, visit our web-site at www.parts3221.com

Or dial Toll Free 1-800-393-0668 Monday-Friday 8AM-5PM

OEM Replacement Parts

Engine Parts	
GXi Part Number	Description
E10211	Fuel Primer Bulb Kit: Includes primer bulb assembly, fuel line, and 2 clamps. Models: 30SB, 30SS, 36SB, 36SS, 45SB, 45SS
B01710	Fuel Tank with gas cap, fuel valve, fuel line, and clamps for 420cc Snow Blower Engine. Models: 36SB, 36SS, 45SB, 45SS
B09611	Oil Fill Plug and Gasket for 420cc & 302cc Snow blower Engine. Models: 30SB, 30SS, 36SB, 36SS, 45SB, 45SS
E11512	Engine Assembly - 302cc Electric Start (Includes complete ready to run engine assembly with fuel tank and recoil. Does NOT include crankshaft pulleys.) Models: 30SS, 30SB
E07610	Engine Assembly - 420cc Electric Start (Includes complete ready to run engine assembly with fuel tank and recoil. Does NOT include crankshaft pulleys.) Models: 36SB, 36SS, 45SB, 45SS
E10811	Engine Recoil Assembly for 302cc Snow blower Engine. Models: 30SS, 30SB
E07910	Engine Recoil Assembly for 420cc Snow blower Engine. Models: 36SB, 36SS, 45SB, 45SS
E11311	Carburetor Assembly for 302cc Snow blower Engine. Models: 30SS, 30SB
E08010	Carburetor Assembly for 420cc Snow blower Engine. Models: 36SB, 36SS, 45SB, 45SS
E08110	Snow blower Safety Key Models: 30SB, 30SS, 36SB, 36SS, 45SB, 45SS
E08210	Fuel Tank Lid. Models: 30SB, 30SS, 36SB, 36SS, 45SB, 45SS
E09211	Snow blower fuel tank screen. Models: 30SB, 30SS, 36SB, 36SS, 45SB, 45SS
E10411	Muffler Cover for 302cc Snow blower Engine. Models: 30SS, 30SB
E10311	Engine Cover for 302cc Snow blower Engine. Models: 30SS, 30SB
E09311	Engine Cover for 420cc Snow blower Engine. Models: 36SB, 36SS, 45SB, 45SS
E09411	Muffler Cover for 420cc Snow blower Engine. Models: 36SB, 36SS, 45SB, 45SS
E09511	Muffler Assembly for 420cc Snow blower Engine. Includes muffler and elbow and air check valve. Models: 36SB, 36SS, 45SB, 45SS
E09611	Oil Fill and Drain Assembly. Includes oil fill neck, dipstick, drain tube and drain bolt. For 420cc & 302cc Snow blower Engine. Models: 30SB, 30SS, 36SB, 36SS, 45SB, 45SS
E10611	120V Electric Start Assembly for 302cc Snow blower Engines. Models: 30SS, 30SB
E09711	120V Electric Start Assembly for 420cc Snowblower Engines. Models: 36SB, 36SS, 45SB, 45SS
E09811	EPA Approved Fuel line - Preformed for 420cc snowblower engine. Includes hose clamps. Models: 36SB, 36SS, 45SB, 45SS
E09911	Snowblower engine on/off switch. Includes safety key. Models: 30SB, 30SS, 36SB, 36SS, 45SB, 45SS
E10011	Plastic choke knob for 420cc & 302cc Snowblower engines. Models: 30SB, 30SS, 36SB, 36SS, 45SB, 45SS

Snow BEAST Additional Parts Listing	
GXi Part Number	Description
B00210	Hardware Bag and Owner's Manual - SNOW BEAST (Includes owner's manual, 3 wrenches, spark plug removal tool, 10 shear pins) Models: 30SS, 36SS, 45SS
B05511	Spring Kit (Includes all drive system springs, clutch return springs, etc) Models: 30SB, 30SS, 36SB, 36SS, 45SB, 45SS
B06711	Shear Bolts (Set of 2) for Auger Shaft Models: 30SB, 30SS, 36SB, 36SS, 45SB, 45SS
B07911	Handlebar Hardware Set (Stanless). Models: 30SB, 30SS, 36SB, 36SS, 45SB, 45SS
B08011	Chassis Hardware Kit Models: 30SB, 30SS, 36SB, 36SS, 45SB, 45SS
B08111	Auger Hardware Kit Models: 30SB, 30SS, 36SB, 36SS, 45SB, 45SS
B10411	Label Kit Model: 30SB
B08811	Label Kit Model: 36SB
B08711	Label Kit Model: 45SB
B09911	Belt Guard hardware kit.
B03111	Headlight Bezel Only (Black Plastic Housing) Models: 30SB, 30SS, 36SB, 36SS, 45SB, 45SS
B03211	Halogen Headlight Replacement Bulb. (Bulb only with socket). Models: 30SB, 30SS, 36SB, 36SS, 45SB, 45SS
B00410	Headlight Wiring Harness with Switch. (Includes headlight socket, wiring with split loom tubing, and headlight on/off switch. Terminals factory attached with installation diagram. Models: 30SB, 30SS, 36SB, 36SS, 45SB, 45SS
B01810	Chute Direction Control Cable. Models: 30SB, 30SS, 36SB, 36SS, 45SB, 45SS
B02110	Discharge Chute Deflector Cable. Includes spring, spring guide and hardware. Models: 30SB, 30SS, 36SB, 36SS, 45SB, 45SS
B03011	Discharge chute angle cable support and hardware. Models: 30SB, 30SS, 36SB, 36SS, 45SB, 45SS

If the part needed is not listed, or you need warranty service, please contact GXi Parts & Service to further assist you at email: customerservice@gxioutdoorpower.com

Products Covered by this Warranty	Length of Warranty: *(from the date of original retail purchase)		
	Noncommercial/ Nonrental	Commercial	Rental
Engine	24 months	90 days	90 days
Transmission	12 months	90 days	90 days
Snow blower	12 months	90 days	90 days

*LENGTH OF WARRANTY: Batteries supplied with applicable products as standard, original equipment are covered by this warranty for a period of 90 days from the date of original retail product purchase. Consumable parts such as oil, spark plugs, belts, shear pins, filters, dirty carburetors, and augers/impeller are not covered by this warranty.

To Qualify for this Warranty

The product must be purchased in the United States from a dealer authorized by GXi Outdoor Power, LLC to sell those products. This warranty applies to first retail purchaser/owner during the applicable warranty time period. **SAVE YOUR PROOF OF PURCHASE RECEIPT.**

What GXi Outdoor Power Will Repair or Replace under Warranty

GXi will repair or replace, at its option, any part that is proven to be **defective in material or workmanship** under normal use during the applicable warranty time period subject to the exclusions stated herein. This warranty is void if the owner fails to follow the prescribed maintenance and operating procedures described in this manual. This specifically refers to ensuring routine lubrication and oil changes are made, that fuel stabilizer is used when the product is stored and that the product is not overloaded.

GXi has the right to recover warranty administration costs from the owner if the root cause of the malfunction is found to be other than defective material or workmanship. In particular, this warranty does not cover: contaminants in the fuel or oil; damage caused by not following the prescribed warnings and operating practices; failure to follow proper maintenance and storage procedures; and physical damage due to misuse, shipping, handling or storage.

Warranty repairs will be made without charge for parts and labor for the first year.

Anything replaced under warranty becomes the property of GXi. Parts replaced under warranty will be considered as part of the original product and any warranty on those parts will expire coincident with the original product warranty.

To Obtain Warranty Service

You must take the BEAST product, accessory, replacement part, apparel or the power equipment on which the accessory or replacement part is installed, and proof of purchase, at your expense, to any BEAST service location in the United States, who is authorized to service that product, during the service location’s normal business hours. If you are unable to obtain warranty service, or are dissatisfied with the warranty service you receive, take the following steps: First, contact the manager of the service center involved; normally this will resolve the problem. However, if you should require further assistance, write or call the GXi Parts and Service, LLC.

Exclusions

This warranty does not cover: normal wear, contaminants in the fuel or oil; damage as a result of use in an application for which the product was not designed; damage caused by incorporation or use of unsuitable attachments or parts, unauthorized alteration, or other misuse and neglect; damage caused by failure to follow the prescribed warnings, operating practices, proper maintenance and storage procedures; parts affected or damaged by accident and/or collision; damage due to shipping, handling, storage or any causes other than defects in material or workmanship of the product. The customer is responsible for transporting the snow-blower to and from the service center. Pick Up & Delivery will depend on if the service center provides this service, and will be made at the owner’s expense.

Disclaimer of Consequential Damage and Limitation of Implied Warranties

GXi disclaims any responsibility for loss of time or use of the product, transportation, commercial loss, or any other incidental or consequential damage. Any implied warranties are limited to the duration of this written limited warranty.

THIS WARRANTY IS VOID IF THE MANUFACTURING DATE AND THE SERIAL NUMBER ON THE EQUIPMENT HAS BEEN REMOVED OR THE EQUIPMENT HAS BEEN MODIFIED.

EMISSION CONTROL SYSTEM INFORMATION

The U.S. and California Clean Air Acts

EPA and California regulations require all manufacturers to furnish written instructions describing the operation and maintenance of emission control systems. The following instructions and procedures must be followed in order to keep the emissions from your BEAST engine within the emission standards. Maintenance, replacement, or repair of the emission control devices and systems may be performed by any engine repair establishment or individual, using parts that are “certified” to EPA standards.

The emission control systems on your BEAST engine were designed, built, and certified to conform with EPA regulations. We recommend the use of genuine BEAST parts whenever you have maintenance done. These original-design replacement parts are manufactured to the same standards as the original parts, so you can be confident of their performance. The use of replacement parts that are not of the original design and quality may impair the effectiveness of your emission control system. A manufacturer of an aftermarket part assumes the responsibility that the part will not adversely affect emission performance. The manufacturer or re-builder of the part must certify that use of the part will not result in a failure of the engine to comply with emission regulations. Emission controls are covered by this warranty for all uses for a period of 2 years from original retail purchase date, this coverage extends to subsequent owners of the product with proof of original purchase. For emissions warranty service call 1-800-393-0668 or e-mail customerservice@gxioutdoorpower.com .