



Professional Series

24" Built-In Dishwasher

Model DW-2400



USER MANUAL

HOUSEHOLD USE ONLY

Your satisfaction is guaranteed. If you are not completely satisfied with our Professional Series 24" Built-In Dishwasher and the results it brings, we insist that you let us know. We'll help you make the Dishwasher work for you, or we'll refund your money.

CONTENTS

IMPORTANT SAFEGUARDS _____	pg 2
Correct usage _____	pg 2
Children _____	pg 3
Technical safety _____	pg 3
Operational safety _____	pg 4
DISHWASHER COMPONENTS _____	pg 7
PRODUCT DIAGRAM _____	pg 8
INSTALLATION _____	pg 9
DISHWASHER SETUP _____	pg 9
Water softener _____	pg 9
Adding the salt into the Water softener _____	pg 11
Fill the Rinse aid dispenser _____	pg 12
Fill the Detergent dispenser _____	pg 13
DISHWARE MATERIALS _____	pg 16
LOADING THE DISHWASHER _____	pg 17
DISHWASHER CYCLES AND OPTIONS _____	pg 20
Wash cycles _____	pg 20
Wash cycle options _____	pg 20
WASH CYCLE INFORMATION _____	pg 21
OPERATING THE DISHWASHER _____	pg 22
TURNING ON THE APPLIANCE _____	pg 23
Starting a wash cycle _____	pg 23
Changing the wash cycle _____	pg 23
Adding a dish during wash cycle _____	pg 24
End of the washing cycle _____	pg 24
MAINTENANCE AND CLEANING _____	pg 25
TROUBLESHOOTING TIPS _____	pg 28
SPECIFICATIONS _____	pg 30

IMPORTANT SAFEGUARDS

THIS DISHWASHER IS PROVIDED WITH AN INSTALLATION INSTRUCTION MANUAL TOGETHER WITH THIS USER MANUAL. READ ALL INSTRUCTIONS BEFORE INSTALLING AND OPERATING YOUR PROFESSIONAL SERIES 24" BUILT-IN DISHWASHER FOR THE FIRST TIME. FAILURE TO ADHERE TO THESE INSTRUCTIONS AND PRECAUTIONS WILL VOID THE MANUFACTURER'S WARRANTY.

To reduce the risk of personal injury or damage to your PROFESSIONAL SERIES 24" BUILT-IN DISHWASHER or other property when using this product, basic safety precautions should always be followed, including the following:

HANDLING AND UNPACKING

- **WARNING: HEAVY UNIT** Use proper equipment and adequate manpower to move the dishwasher to avoid personal injury or damage to the unit or the floor.
- Before moving the dishwasher, protect any finished flooring and secure the dishwasher door closed to prevent damage.
- **WARNING: TIP-OVER HAZARD** Opening the door will cause the dishwasher to tip forward. Do not open the door until you are ready to install the dishwasher. If it is necessary to open the door, hold the top of the dishwasher securely with one hand and hold the door with the other hand.
- **WARNING: DO NOT LIFT OR CARRY THE DISHWASHER BY THE DOOR OR CONTROL PANEL.**
- Keep the appliance at room temperature for at least 8 hours after receiving the product in the winter season.
- Remove any packaging including cable ties on the drainage pipe and power cord carefully during unpacking. Sharp scissors might burst the drainage pipe or power cord, which may cause a potential leakage.

CORRECT USAGE

- This appliance is intended for use in domestic households and in similar working and residential environments. NSF/ANSI 184 Certified residential dishwashers are not intended for licensed food establishments.
- **WARNING:** Misuse of the dishwasher can result in serious injury or death. Do not use the dishwasher in any way not covered in this manual or for any purpose other than those explained in the following pages.
- This appliance is not intended for outdoor use.
- **Persons (including children) who lack physical, sensory, or mental capabilities, or experience with the appliance should not use it without supervision or instruction by a responsible person.**

CHILDREN

- Never allow children to play in, on, or with the appliance. To reduce risk of injury, close supervision and observation of children is needed around the dishwasher.
- Never allow children to sit or stand on any part of the appliance, including the door.
- Do not store items of interest to children inside the appliance. Children pulling down the door, climbing, or putting their hands inside could be injured.
- The appliance is hot during use and remains so for some time after being switched off. Keep children away from the appliance door, particularly when opening where steam may disperse.
- **Keep all dishwasher detergents, in particular tablet/pod form, out of reach of children. Harmful if swallowed, and an eye irritant.**

WARNING: Ensure that any packing material, including any plastic bags or film, are disposed of safely and kept out of the reach of children. Do not use plastic bags in cribs, beds, carriages or play pens. These bags are not toys. Danger of suffocation!

TECHNICAL SAFETY

- **IMPORTANT: Refer to the included 'INSTALLATION INSTRUCTIONS' for important information and instructions for correct installation.**
- Installation of this dishwasher requires basic mechanical and electrical skills. Proper installation is the responsibility of the installer. Product failure due to improper installation is not covered under the Appliance Warranty.
- Before installation, make sure that the voltage and frequency listed on the rating label correspond with the household electrical supply. This data must correspond to prevent injury and appliance damage. Consult a qualified electrician if in doubt.
- Before installation, select a suitable area that abides by the cabinet measurements with suitable electrical and water supply as noted in the 'INSTALLATION INSTRUCTIONS'.
- Do not try to use this appliance in damp place. High humidity will make the appliance rust.
- Before installing the dishwasher, check for externally visible damage. Do not operate a damaged appliance. A damaged appliance is a hazard.
- Electrical shock or fire could result if the electrical supply for the dishwasher covered in this manual is incorrectly installed or if the dishwasher has been improperly grounded.

WARNING: Do not use the dishwasher covered in this manual unless you are certain the electrical supply has been correctly installed and the dishwasher has been properly grounded.

- This appliance must be grounded. In the event of a malfunction or breakdown, grounding will reduce the risk of electric shock by providing a path of least resistance for electric current. This appliance is equipped with a cord having an equipment-grounding conductor and a grounding plug. The plug must be plugged into an appropriate outlet that is installed and grounded in accordance with all local codes and ordinances. **DO NOT cut or remove the grounding prong from this plug.**
- **WARNING:** Improper connection of the equipment-grounding conductor can result in a risk of electric shock. Check with a qualified electrician or service representative if you are in doubt whether the appliance is properly grounded. Do not modify the plug provided with the appliance, if it will not fit the outlet, have a proper outlet installed by a qualified electrician.
- Do not use the dishwasher until properly leveled.
- **WARNING:** To reduce the risk of electric shock, fire, or injury to persons, the installer must ensure that the dishwasher is completely enclosed at the time of installation.
- Do not use an adapter or extension cord to connect this appliance to electricity. Extension cords do not guarantee the required safety of the appliance.
- To reduce the risk of injury, immediately replace loose or defective power cords, loose plugs and/or power outlets.
- Do not operate this appliance unless all enclosure panels are properly in place.
- Before servicing, disconnect the water intake hose and power supply.
- Under no circumstance open the outer casing or controls of the appliance. This is a safety hazard and may damage the appliance.
- Severe product damage and/or injury could result from the use of unqualified service technicians or non-original replacement parts. All repairs must be performed by a qualified service technician using only original equipment factory replacement parts. Do not attempt to repair the appliance yourself.
- Do not operate the appliance if the power cord or plug is damaged, or if the appliance has been damaged in any manner.
- In the event of damage or defect, turn off the appliance immediately. Turn off the water supply and disconnect completely from the electrical supply. Do not use the appliance until it has been repaired. Ensure power is not supplied to the appliance while repair work is carried out.
- Before discarding an old appliance, disconnect it from the water and electrical supply, and cut off the power cord to prevent it from becoming a hazard.

OPERATIONAL SAFETY

- Do not operate your appliance in the presence of explosive fumes.
- Do not add or mix any flammable or explosive substances to wash.
- Do not operate your appliance when parts are missing or broken.
- Do not abuse, sit on it, or stand on the door or the dishwasher rack.
- Do not unplug your appliance by pulling on the power cord. Always grasp the plug firmly and pull it straight out from the outlet.
- This dishwasher is an automatic appliance, do not add water manually when the appliance is working. It will cause overflow and danger.
- Use only specialized detergents or wetting agents recommended for use in a dishwasher. Do not use washing-up liquid, washing powder, hand sanitizer soap or other detergents that not are specialized for a dishwasher.
- Do not wash plastic items unless they are marked "dishwasher safe" or the equivalent. For plastic items without such markings, check the manufacturer's recommendations.
- Do not load the dishwasher with paper products, plastic bags, packing materials or anything other than normal, dishwasher safe dishware and kitchenware.
- Knives and other sharp utensils with sharp points must be loaded in the basket with their points facing downwards or placed in a horizontal position.
- Ensure no sharp items are not close to the front of the dishwasher to prevent accidental piercing of the door seal.
- Utensils will be hot after washing. Allow 30 minutes to cool off before taking out.
- Always use caution when opening the door during or following a wash cycle as hot water or steam may escape. Do not fully open the door until water noises have stopped and steam has subsided. If it is necessary to load or unload some utensils, please push pause button and wait 10 seconds, then open the door slightly and wait for the steam to dissipate completely, then open the door and move your utensils.
- Never operate the dishwasher without the filter assembly in place. Always reinsert in the correct order.
- The interior tub base will be extremely hot after use. DO NOT touch.
- Do not move or clean the appliance while it is working. It might cause electrical or water leakage.
- To avoid floor damage and possible mold growth, do not allow wet areas to remain around or under the dishwasher.
- Before cleaning, disconnect the water supply hose and power supply.

- Never use harsh chemicals or abrasive cleaners to clean your dishwasher. Some chloride-containing products can damage your dishwasher and may present health hazards.
- Never use steam cleaning products to clean your dishwasher. The manufacturer will not be responsible for possible damages or consequences.
- Protect your dishwasher from the elements. Protect against freezing to avoid possible damage to the fill valve. Damage caused by freezing is not covered by the warranty.
- If your old appliance is not being used or will be discarded, we recommend that you store the unit out of reach of children and remove its door. This will reduce the risk of injury to children.
- Hydrogen gas may be produced if the water heater has not been used in more than two weeks. This could be explosive and can explode under certain circumstances. If this is the case, before using this appliance, turn on all the hot water faucets and let the hot water run for a few minutes. This will let the trapped hydrogen escape. During this process do not turn on an electric appliance, smoke, light a match or lighter, or use a flame to avoid serious injury, due to the highly flammable nature of hydrogen gas.

KEEP THIS MANUAL IN A SAFE PLACE FOR FUTURE REFERENCE AND REVIEW PERIODICALLY.

DISHWASHER COMPONENTS



REFER TO 'OPERATING THE DISHWASHER' FOR FURTHER DESCRIPTION

Additional Features	Description
Time Remaining Indicator	Indicates the cycle time remaining.
49dBA Sound Level	Quiet washing.
Delay Start	Start of a cycle can be delayed in 1-hour increments up to 24 hours.
Rinse Cycle	If you need to pre-rinse dishes to avoid odors, let the dishwasher do the work for you. Place unrinsed dishes inside dishwasher and select the "Rinse" cycle. Uses less water than hand rinsing and very low energy. Note: Do not use detergent in this cycle.
Plastic Item Clips	Securely holds light-weight plastic accessories (cups, lids, etc.).
Low Salt Notification Light	Illuminates to indicate Salt is low.
Low Rinse Aid Notification Light	Illuminates to indicate Rinse Aid is low.
Sanitized Notification Light	Illuminates to indicate sanitation requirements are met.
Energy Efficient 270kWh	ENERGY STAR certified.

PRODUCT DIAGRAM

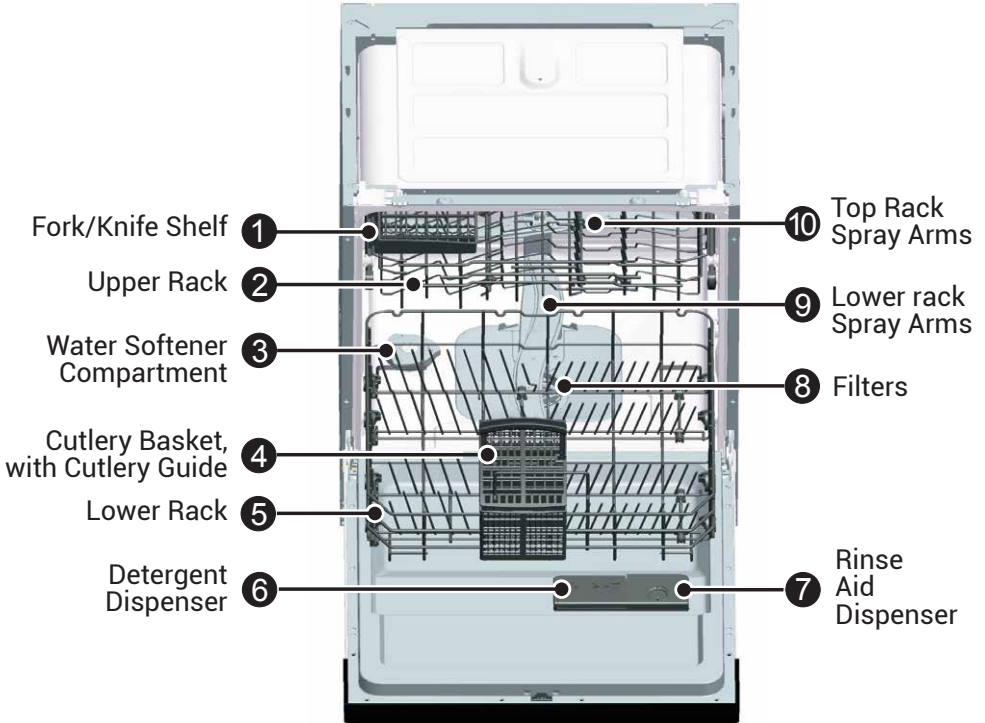

Funnel - For Water Softener Compartment

INSTALLATION

REFER TO THE 'INSTALLATION INSTRUCTIONS' BOOKLET INCLUDED WITH YOUR APPLIANCE FOR COMPLETE INFORMATION ON INSTALLING YOUR APPLIANCE.

IMPORTANT: The installation of the pipes and electrical components of this appliance should be carried out by a service professional.



⚠ WARNING: ELECTRICAL SHOCK HAZARD

Disconnect electrical power before installing the dishwasher. Failure to do so can result in electrical shock or possible death.

DISHWASHER SETUP

Before using your dishwasher for the first time:

- A) Adjust the Water softener
- B) Add the salt into the Water softener
- C) Fill the Rinse aid dispenser
- D) Fill the Detergent dispenser

A) WATER SOFTENER:

The water softener is designed to remove minerals and salts from the water, which would have a detrimental or adverse effect on the operation of the appliance. The higher the content of these minerals and salts, the harder the water is. The softener should be adjusted according to the hardness of the water in your area. Your local Water Authority can advise you on the hardness of the water in your area.

WATER SOFTENER

The hardness of the water varies from place to place. If hard water is used in the dishwasher, deposits will form on the dishes and utensils.

The appliance is equipped with a special softener that uses salts specifically designed to eliminate lime and minerals from the water.

Adjusting the settings:

The amount of salt dispensed can be set from H0 to H7.

Salt is not required at the set value H0.

1. Find out about the hardness value of your tap water. Your water utility company may help you with this.
2. Use the Water hardness table (listed below) to set the value on your dishwasher based on the hardness of your tap water.
3. Close the door.
4. Press the "Power" button.
5. Hold down the "Delay" button and then press the "Program" button for 5 seconds. The buzzer rings one time, and "H" .. flashes on the digital display. (Factory setting is H0)

Water hardness table

Water hardness		Mmol/l	Set value on the machine
°Clark	Range		
0-8	soft	0-1.1	H0
9-10	soft	1.2-1.4	H1
11-12	medium	1.5-1.8	H2
13-15	medium	1.9-2.1	H3
16-20	medium	2.2-2.9	H4
21-26	hard	3.0-3.7	H5
27-38	hard	3.8-5.4	H6
39-62	hard	5.5-8.9	H7

To change the settings:

1. Press the " Delay " button.

Each time the button is pressed, the set value increases by one level; when the value of H7 has been reached, the display goes back to H0 (off).

2. When you have adjusted to the desired level, press the" Program " button. The chosen setting has now been stored.

B) ADDING THE SALT INTO THE WATER SOFTENER:

Always use salt intended for use with the dishwasher.

ATTENTION! Only use salt specifically designed for use in dishwashers! All other types of salt not specifically designed for use in a dishwasher, especially table salt, will damage the water softener. In case of damage caused by the use of unsuitable salt, the manufacturer does not give any warranty nor is liable for any caused damages caused.

Only fill with salt just before starting one of the complete washing programs.

This will prevent any grains of salt or salty water from remaining on the bottom of the machine for any period of time, which may cause corrosion.

After the first wash cycle, the control panel light goes OFF.

The Water softener/Salt compartment is located beneath the lower rack and should be filled as follows:



1) Remove the lower rack, then unscrew and remove the cap from the Water softener/Salt compartment. (illustration 1)

2) Before using the appliance for the first time, pour about 17oz / 500 ml of water in the salt compartment.

3) Using the funnel, fill with dishwasher salt (max. 3.3lbs / 1.5kg) until the salt container is full. When you refill the salt, it is normal for small amount of water to be displaced and to drains off.

4) Carefully screw the compartment cap back on.

WARNING: Risk of Corrosion. Immediately after filling the compartment, run the "Express" program and without any crockery in the dishwasher to remove any traces of salt from the dishwasher base.

NOTE: It may take up to 2-6 days for the salt warning light to turn OFF, after the Water softener/Salt compartment is filled with salt.

NOTE: The compartment must be refilled when the salt warning light on the control panel turns ON. Once the compartment is filled enough, the indicator light may not turn OFF before the salt fully dissolves.

C) FILL THE RINSE AID DISPENSER:

Rinse aid function:

The rinse aid is released during the final rinse to prevent water from forming droplets on your dishes that can leave spots and streaks. It also improves drying by allowing water to 'sheet' off the dishes.

The rinse aid dispenser is located on the interior side of the door next to the detergent dispenser.

Your dishwasher is designed to use liquid rinse aids.

ATTENTION! Only use branded rinse aid for the dishwasher. Never fill the rinse aid dispenser with any other substances (e.g., dishwasher cleaning agent, liquid detergent). This will damage the appliance.

When to refill the Rinse aid dispenser:

The Rinse aid compartment must be refilled when the warning light on the control panel turns ON. You can also judge the amount of rinse-aid by the color of the optical level rinse aid indicator located next to the cap. When the rinse-aid container is full, the whole indicator will be dark. As the rinse aid diminishes, the size of the dark dot decreases. It would be best if you never let the rinse aid get below 1 / 4 full.

As the rinse aid diminishes, the size of the black dot on the rinse aid level indicator changes, as illustrated below.

- Full
- ◐ 3 / 4 full
- ◑ 1 / 2 full
- ◒ 1 / 4 full - Should refill to eliminate spotting
- Empty

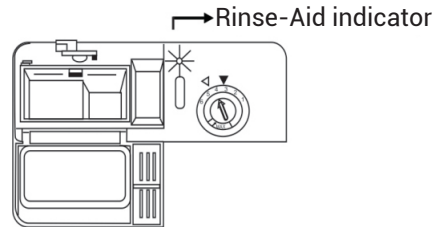

RINSE AID DISPENSER

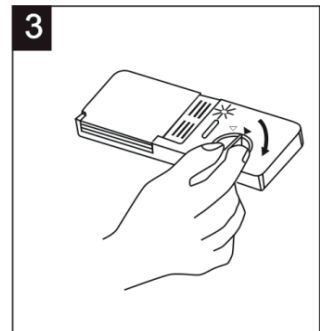
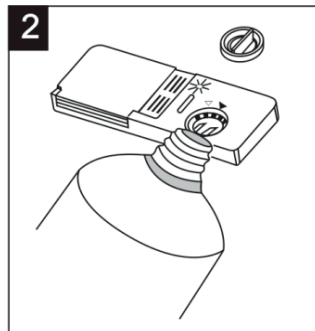
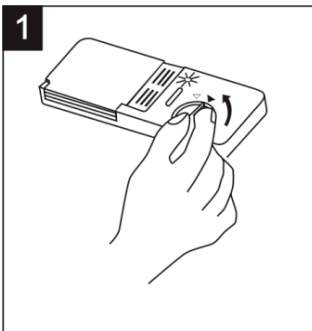

1. To open the dispenser, turn the cap to the "open" position (left arrow) and lift it out.
2. Pour the rinse aid into the dispenser, be careful not to overfill. The volume of the rinse aid container is about 4.7 oz / 140ml.

ATTENTION! Do not overfill and clean up any rinse aid spilled during filling with an absorbent cloth to avoid excess foaming during the next wash.

3. Replace the cap by inserting it aligned with the "open" arrow and turning it to the "closed" (right arrow) position.

Adjusting the Rinse aid dispenser:

The rinse aid dispenser has four settings (depending on model). Always start with the dispenser set on "2". If spots and poor drying problems appear, increase the amount of rinse aid dispensed by removing the dispenser lid and rotating the dial to "3". If the dishes are still not drying properly or are spotted, adjust the dial to the next highest number until your dishes are spot-free.

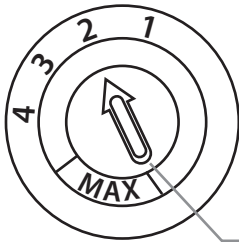

Adjust lever (Rinse)

D) FILL THE DETERGENT DISPENSER:

Function of the Detergent:

Detergents with their chemical ingredients are necessary to remove, break down, and transport residue out of the dishwasher. Most commercial quality detergents are suitable for this purpose.

Concentrated Detergent

Based on their chemical composition, the detergents can be placed into two basic types:

- conventional, alkaline detergents with caustic components, and
- low alkaline concentrated detergents with natural enzymes.

The use of the "Normal" washing program in conjunction with concentrated detergents reduces pollution and is good for your dishes; these washing programs are specially matched to the soil-dissolving properties of the enzymes of the concentrated detergent. For this reason, the "Normal" washing program in which concentrated detergents are used can achieve the same results that can otherwise only be achieved using an "intensive" program.

Detergent Tablets/Pods

Detergent tablets/pods of different brands dissolve at a different rate. For this reason, some detergent cannot dissolve and develop their full cleaning power during short programs. Therefore, please use long programs (Heavy, Normal, Delicate) when using detergent tablets/pods to ensure the complete removal of detergent residuals.

Detergent Dispenser

The dispenser must be refilled before the start of each washing cycle, following the instructions provided in the Wash Cycle Table. Your dishwasher uses less detergent and rinse aid than conventional dishwashers. Generally, only **one tablespoon** of detergent is needed for an average wash load. Also, more heavily soiled items need more detergent. Always add the detergent just before starting the dishwasher; otherwise, it could get damp and will not dissolve properly.

Adding the detergent to the Detergent dispenser:

The marking engraved within the detergent chambers indicates the dosing levels, as presented in the illustration below:

- 1) Main Wash detergent compartment:
"MIN" amount - approximately 0.7oz / 20g of detergent.
"MAX" amount - approximately 2.3oz / 65 g of detergent.
- 2) Pre-Wash detergent compartment:
Marking - approximately 0.27oz / 7.5g of detergent.

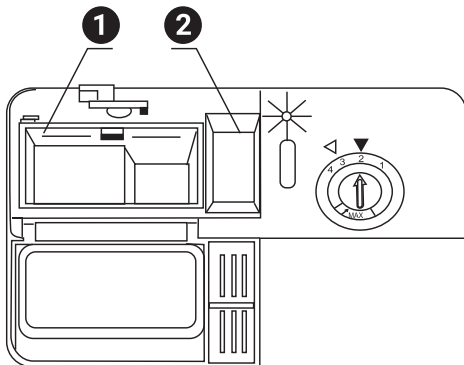

To fill the Detergent dispenser with detergent:

1. Press the release button located on the lid of the Detergent dispenser. The lid will open.
2. Add one tablespoon of the detergent powder, or one tablet/pod.
3. If the dishes are heavily soiled, place an additional detergent dose in the pre-wash detergent chamber. This detergent will take effect during the pre-wash phase.
4. Close the lid and press until it locks in place.

NOTE: It is not recommended to use detergent pods (3-in-1) for Light, Express, and Rinse wash cycles, as some detergent residue may appear due to short time length of these cycles.

WARNING! Dishwasher detergent is corrosive! Keep out of reach of children!

WARNING: Dishwasher detergents can cause burning in the nose, mouth and throat if swallowed, or inhibit breathing. Avoid inhalation of powder detergents and do not ingest dishwasher detergent. Seek medical attention immediately if detergent has been swallowed or inhaled. Keep detergent out of the reach of children at all times. Keep children away from the dishwasher when the door is open. There could still be detergent residues in the dispenser. Only add detergent just before starting the program and close the door, activating the safety lock.

NOTE: Use only detergent specifically made for use in dishwashers. Keep your detergent fresh and dry. Don't put powder detergent into the dispenser until you're ready to wash dishes.

Please be aware that according to the level of soiling and the specific hardness of water, differences are possible.

Please observe the manufacturer's recommendations on the detergent packaging.

Detergents:

There are 3 sorts of detergents:

1. With phosphate and with chlorine.
2. With phosphate and without chlorine.
3. Without phosphate and without chloride.

Normally new pulverized detergent is without phosphate. The water softener function of phosphate is not given. In this case, we recommend filling salt in the salt container even when the hardness of water is only 6 dH. If detergents without phosphate were used in case of hard water, often white spots appear at dishes and glasses. In this case, please add more detergent to reach better results. Detergents without chlorine only bleach a little. Strong and colored spots will not be removed completely. In this case, please choose a program with a higher temperature.

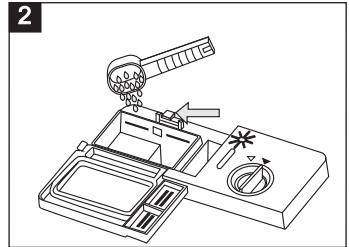
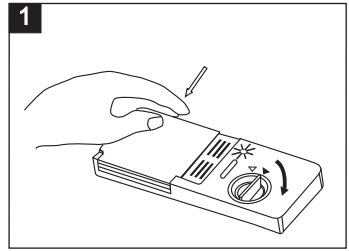

DISHWARE MATERIALS

NOTE: Before using your dishwasher for the first time, check the information in this section.

Some items are not dishwasher safe and should be hand-washed; others require special loading.

Notes Prior to Dishwashing

Aluminum: Colored anodized aluminum may fade over time. Minerals in your water may cause the aluminum to darken or spot. This can usually be removed with a soap-filled steel wool pad.

China, Crystal, Stoneware: Some hand-painted utensils may discolor, fade, or spot. Handwash these utensils. Position fragile glassware so that it will not fall over or come in contact with other utensils during the wash cycle.

Glass: Milk glasses may discolor or become yellow.

Non-stick Coatings: Apply a light coating of vegetable oil to non-stick surfaces after drying.

Plastics: Make sure the plasticware is dishwasher safe.

Stainless Steel, Sterling Silver, and Silver Plates: Load these so they do not come in contact with other metals.

Not Recommended

Acrylic: Crazing, small cracks throughout the acrylic may occur.

Adhesive-Joined Pieces: Adhesives that join materials such as plastic, wood, bone, steel, copper, tin, etc., may loosen.

Bone-Handled Utensils: Handles may separate.

Iron: Iron will rust. Hand wash and dry immediately.

Non-Dishware items: Your dishwasher is intended for use in cleaning ONLY standard household dishware and kitchenware.

Pewter, Brass, Bronze: These items will tarnish. Hand wash and dry immediately.

Tin: Tin will stain. Hand wash and dry immediately.

Wood: Wooden bowls, wooden utensils, and utensils with wooden handles can crack, warp and lose their finish.

LOADING THE DISHWASHER

For the best performance of the dishwasher, follow these loading guidelines. Features and the appearance of rack and silverware baskets may vary from your model.

Before Loading the Dishwasher racks:

Scrape off any large amounts of leftover food. It is not necessary to rinse the dishes under running water.

Place objects in the dishwasher in the following way:

1. Items such as cups, glasses, pots/pans, etc., are to be placed upside down.
2. Curved items, or those with recesses, should be at a slant so that water can runoff.
3. Make sure that the dishware is stacked securely and cannot tip over.
4. Make sure that dishware or the utensils do not prevent the spray arms from rotating during the washing cycle.

NOTE: Very small items should not be washed in the dishwasher as they could easily fall out of the basket or rack.

NOTE: To avoid dishwasher damage, do not load the dishwasher with paper products, plastic bags, packing materials, or anything other than normal, dishwasher safe dishware and kitchenware.

WARNING: The sharp points and edges of knives and other sharp utensils can cause serious injuries. Load knives and other sharp utensils with edges facing down. Do not allow children to handle or play near knives and sharp utensils.

Loading the Upper rack:

The upper rack is designed to hold more delicate and lighter dishware such as glasses, coffee and teacup, saucers, as well as small plates, small bowls and shallow pans (as long as they are not too dirty). Position the dishes and cookware so that they do not get moved by the spray of water.

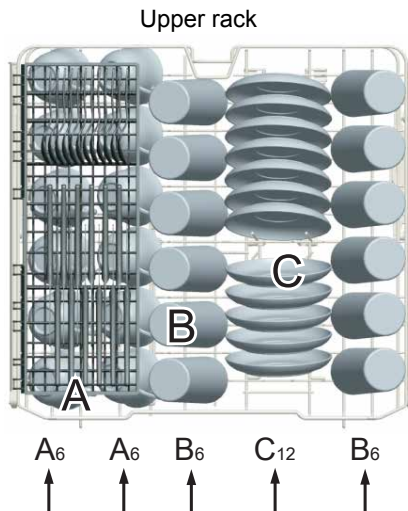

Upper rack	
Type	Item
A	Coffee Cup
B	Glass
C	Saucer

Adjusting the Upper rack:

If required, the upper rack's height can be adjusted to create more space for large dishware or utensils either in the upper or lower racks. The upper rack can be adjusted by pulling out to remove, and repositioning the rail between the different wheel heights.

NOTE: Long items, serving cutlery, salad servers, or knives should be placed horizontally on the rack, or Fork/Knife shelf in the Upper rack, so that they do not obstruct the rotation of the spray arms.

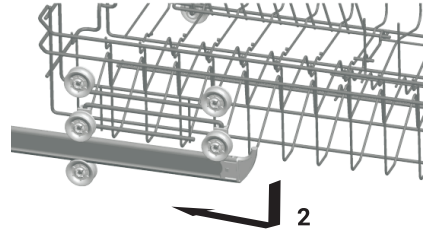
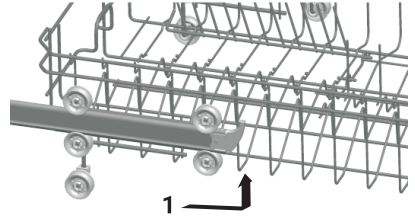
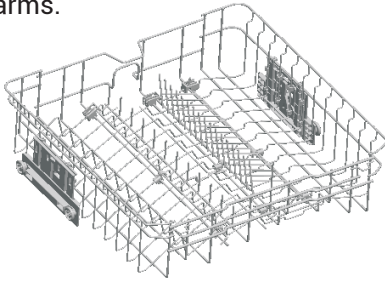

Loading the Lower rack

We recommend that you place large items that are more difficult to clean into the lower rack: pots, pans, lids, serving dishes, and bowls, as shown in the figure below.

It is preferable to place serving dishes and lids on the side of the racks in order to avoid blocking the rotation of the top spray arm.

Pots, serving bowls, etc., must always be placed top down.

Deep pots should be slanted to allow water to flow out.

Lower rack

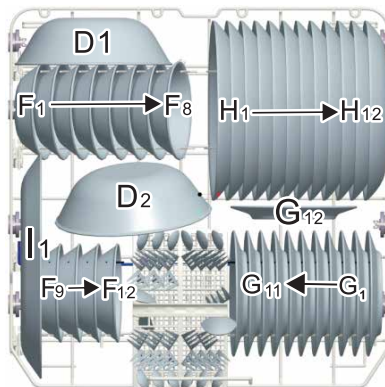

Lower rack	
Type	Item
D	Serving bowl
F	Fruit bowl
G	Bread plate
H	Dinner plate
I	Serving Oval platter

ATTENTION: Do not put into the dishwasher items that are dirty from cigarette ash, candle wax, lacquer, or paint.

NOTE: Do not use dishware that is not suitable for dishwashers. This is important for good results and for reasonable energy consumption.

Please do not overload your dishwasher.

Upper and Lower rack Folding racks

Folding racks consisting of three/two parts in the upper/lower rack of your dishwasher are designed to allow you to place large items such as pots, pans, etc. If requested, each part can be folded separately, or all of them can be folded to create more space in the racks. You can use folding racks by raising them upwards or by folding them down.

Upper rack:

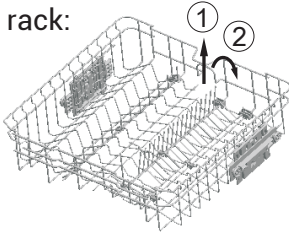

Lower rack:

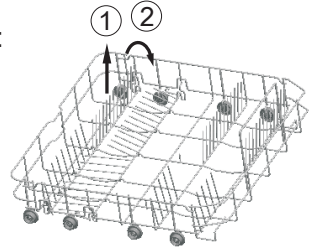

Cutlery Basket

Cutlery should be placed in the cutlery basket with handles at the bottom. Any long knives or utensils should not be placed in the cutlery basket. Instead, place horizontally in the Upper Rack, or the designated Fork/Knife shelf in the Upper rack.

ATTENTION: Ensure that the cutlery does not impede the rotation of the spray arms.

ATTENTION: LONG BLADED KNIVES STORED IN AN UPRIGHT POSITION ARE A POTENTIAL HAZARD! LONG AND/OR SHARP ITEMS OF CUTLERY SUCH AS CARVING KNIVES MUST BE POSITIONED HORIZONTALLY IN THE UPPER RACK OR FORK/KNIFE SHELF IN THE UPPER RACK!

Fork shelf

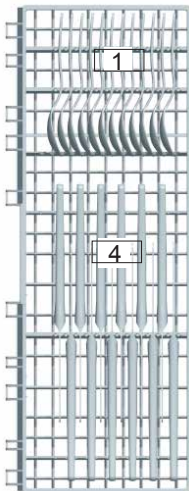

Cutlery basket

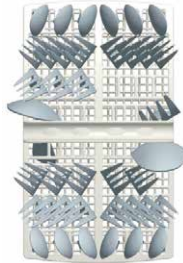

Door side

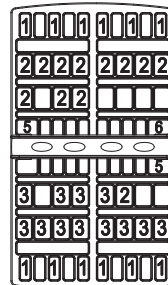

Cutlery basket	
Type	Item
1	Teaspoon
2	Dinner Fork
3	Salad Fork
4	Knife
5	Serving Spoon
6	Serving Fork

NOTE: Please do not overload your dishwasher. There is only space for 12 standard dishes.

Removing the Dishes

ATTENTION: The dishes are hot and easily breakable immediately after washing cycle. Please allow 30 minutes for dishes to cool off before unloading the dishwasher.

To prevent water from dripping from the upper basket into the lower basket, we recommend that you empty the lower rack first and then the upper rack.

DISHWASHER CYCLES AND OPTIONS

WASH CYCLES:

Heavy: Best for cleaning items with baked-on food or grease. These dishes would normally require soaking.

Normal: This cycle is recommended to completely wash and dry a full load of normally soiled dishes. The energy usage label is based on this cycle and option combination.

Delicate: Provides a light wash and gentle dry for delicate items such as china and crystal.

Light: Cleans lightly soiled dishes and reduces overall wash time. Use this cycle to clean glasses and dessert dishware that may need to be reused at the event.

Express: When you need fast results, the Express Wash cycle will clean your dishes using slightly more water and energy. Then, towel dry dishes for immediate use. Select Sanitize if you want to add a drying option.

Rinse: It allows you to rinse food soil off a partial load and hold the dishes in the dishwasher until you are ready to run a full load.

NOTE: It is not recommended to use detergent pods (3-in-1) for Light, Express, and Rinse wash cycles, as some detergent residue may appear due to short time length of these cycles.

WASH CYCLE OPTIONS:

Delay Start: Allows you to delay the start time of your dishwasher in one-hour increments for up to 24 hours.

Sanitize: The Sanitize feature increases the temperature during the final rinse stage, and is available with any cycle except Rinse. Select one of these cycles, press the "Sanitize" button and then press Start to activate the Sanitation features.

The sanitize LED light will illuminate when sanitation requirements are met. The technical sanitation measures may also improve the drying results.

Upper Wash/Lower Wash: The features are available with any cycle. For convenience, use it to wash a small load of dishes in the Upper rack only or Lower rack only to help keep the kitchen continuously clean.

WASH CYCLE INFORMATION

The cycle's time duration is based on average soil loads and 120°F water intake temperature and will vary based on the actual conditions.

WASH CYCLE INFORMATION

	Heavy	Normal	Delicate	Light	Express	Rinse
cycle time	175min	144min	96min	70min	50min	12min
water consumption	22.3L 5.9gal	12.1L 3.2gal	11.7L 3.1gal	9.1L 2.4gal	9.1L 2.4gal	3.8L 1.0gal
water temperature	50-65°C 122-149°F	50-53°C 122-127°F	50°C 122°F	50-55°C 122-131°F	40°C 104°F	Water inlet temperature
rinse temperature	65°C 149°F	60°C 140°F	60°C 140°F	60°C 140°F	60°C 140°F	Water inlet temperature
Sanitize						
cycle time	180min	154min	106min	80min	60min	n/a
water consumption	22.3L 5.9gal	12.2L 3.2gal	11.7L 3.1gal	9.1L 2.4gal	9.1L 2.4gal	n/a
water temperature	50-65°C 122-149°F	50-53°C 122-127°F	50°C 122°F	50-55°C 122-131°F	40°C 104°F	n/a
rinse temperature	70°C 158°F	70°C 158°F	70°C 158°F	70°C 158°F	70°C 158°F	n/a
Upper Wash/ Bottom Wash						
cycle time	175min	144min	96min	70min	50min	12min
water consumption	22.3L 5.9gal	12.1L 3.2gal	11.7L 3.1gal	9.1L 2.4gal	9.1L 2.4gal	3.8L 1gal
water temperature	50-65°C 122-149°F	50-53°C 122-127°F	50°C 122°F	50-55°C 122-131°F	40°C 104°F	Water inlet temperature
rinse temperature	65°C 149°F	60°C 140°F	60°C 140°F	60°C 140°F	60°C 140°F	Water inlet temperature

OPERATING THE DISHWASHER

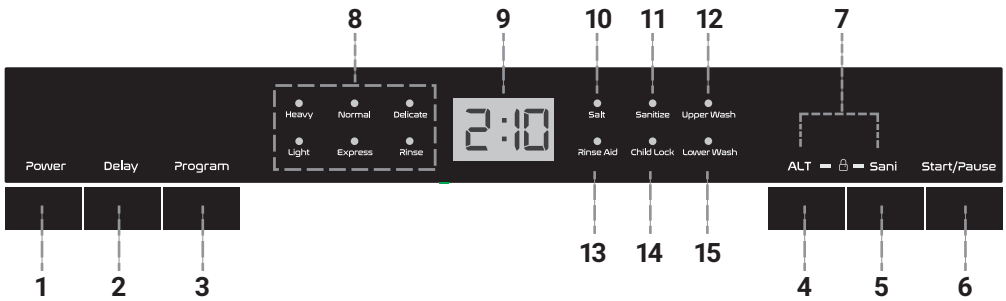

NOTE: Buttons are sensitive and should be touched gently. Avoid any grease or food particles resting on the buttons as they could activate the dishwasher. Wiping and cleaning can also activate the dishwasher. For best results, use bare, clean hands when touching the buttons.

WARNING: To avoid the risk of injury, always use caution when opening the door during or following a wash cycle as hot water or steam may escape. Do not fully open the door until water noises have stopped and steam has subsided.

- 1. Power button:** Power ON/OFF button.
- 2. Delay button:** Allows you to delay the start of any wash cycle for up to 24 hours.
- 3. Program button:** Press the button to scroll through the wash cycles. The corresponding program light will illuminate to indicate which wash cycle has been selected.
- 4. Function alternative (ALT) button:** Press this button to choose the additional function washing of the upper rack or washing of the lower rack. The corresponding light will illuminate.
- 5. Sanitize button:** Provides an increased temperature during the final rinse stage which improves the drying process.
- 6. Start/Pause button:** The appliance will start or pause the selected washing cycle.
- 7. Child lock:** Press the ALT button and Sani button together at the same time for 3 seconds to lock the appliance and disable the button's functions.
- 8. Program indicator lights:** When selecting the wash cycle, the corresponding light will illuminate.
- 9. Digital display:** Displays the wash cycle remaining time, malfunction codes, and delay time.
- 10. Salt indicator:** The indicator light turns ON when the water softener dispenser needs a refill.
- 11. Sanitize indicator:** The indicator light will illuminate when the Sanitize button is selected.

12. Upper Wash indicator light: The light illuminates when the Upper layer feature is selected, and the upper spray arm is in motion.

13. Rinse aid refill indicator: The indicator light turns ON when the rinse aid dispenser needs a refill.

14. Child lock indicator: The "Child Lock" indicator light flashes 6 times and then stays solid once the Child lock buttons (ALT + Sani) are pressed and held for 3 seconds.

15. Lower Wash indicator light: The light illuminates when the Lower layer feature is selected, and the lower spray arm is in motion.

TURNING ON THE APPLIANCE

STARTING A WASH CYCLE:

1. Pull out the lower and upper racks, load the dishes, and push the racks all the way back. It is recommended to load the lower rack first, then the upper one (see the section entitled "Loading the Dishwasher"). Pour in the detergent (see the section entitled "Dishwasher Setup").

2. Insert the plug into the socket. You must have: 120-volt, 60Hz, AC-only, 10-or 12-amp, fused electrical supply.

Make sure that the water supply is turned on to full pressure.

3. Close the door, using a little force to ensure it latches properly.

NOTE: A click could be heard when the door is properly closed.

4. Press the "Power" button. Press the "Program" button to select a desired "Wash cycle". (See the section entitled "Wash Cycle Information").

5. Press the Start/Pause button, and the dishwasher will start the wash cycle.

When the washing cycle is over, you can shut off the dishwasher by pressing "Power" button.

CHANGING THE WASH CYCLE:

Prerequisite: The ongoing cycle can only be modified if the detergent dispenser cover is not open (the door can be opened for viewing). Otherwise, the detergent may have already been released, and the appliance may have already drained the wash water. If this is the case, the detergent dispenser must be refilled (see the section entitled "Fill the Detergent Dispenser").

Press the "Power" button to cancel the program, and press it on again to change the program to the desired wash cycle setting (see the section entitled "Starting a wash cycle").

NOTE: If you open the door during the wash cycle, the machine pauses, and the warning alarm rings. On display appears E1.

When you close the door, you must press the Start/Pause button and the the dishwasher will continue to work.

The 6 program lights show the state of the dishwasher:

a) One of the program lights illuminated --> cycle running

b) One of the program lights blinking --> pause

NOTE: If all the lights begin to glimmer, that indicates the machine is out of order; please turn off the main power and water supply before calling an authorized service provider.

ADDING A DISH DURING WASH CYCLE:

A forgotten dish can be added at any time before the detergent dispenser lid opens.

1. Carefully open the door a little bit to stop the wash cycle.
2. After the spray arms stop working, you can open the door completely.
3. Add forgotten dishes to the rack.
4. Close the door, and the dishwasher will continue the wash cycle after ten seconds.

WARNING: It is dangerous to open the door during the washing cycle because the hot water may scald you.

END OF THE WASHING CYCLE:

Once the washing cycle has finished, the buzzer of the dishwasher will ring 6 times, and then it will go off.

Turn off the appliance using the "Power" button, shut off the water supply and open the door of the dishwasher ajar. Take caution as hot steam is likely to escape. Wait a few minutes before unloading the dishwasher to avoid handling the dishes and utensils while they are still hot and more susceptible to breakage. The dishes will also dry better if you leave them in the dishwasher for some time after the washing cycle ends.

MAINTENANCE AND CLEANING

Prior to initial use it is recommended to fill the Water Softener Compartment, Detergent Dispenser and Rinse Aid Dispenser and run an empty program cycle to remove any foreign manufacturing testing residue. Any yellow-colored water initially is normal and will dissipate with use.

For optimal performance it is important to take the time to ensure the interior of your dishwasher is clean.

Warning: Before thorough cleaning of your dishwasher, always disconnect the power plug from the socket. Pressing the Power ON/OFF button to the OFF position does NOT disconnect the appliance from the power supply.

FILTERING SYSTEM

The filters are used to avoid large food remnants and other residues getting inside the dishwasher pump. The residue can obstruct the filter in sometime.

The filter system consists of 3 components:

1. Coarse Filter

Larger debris, such as bone and glass that could clog the drain will be trapped in the coarse filter. To remove an item caught in this filter, gently squeeze the tabs on the top of this filter and lift it out.

2. Micro Filter

This filter holds soil and food residue in the sump area and prevents it from being redeposited on the dishes during a cycle.

3. Flat Filter (Main Filter)

Food and debris will be trapped by a special jet on the lower spray arm.

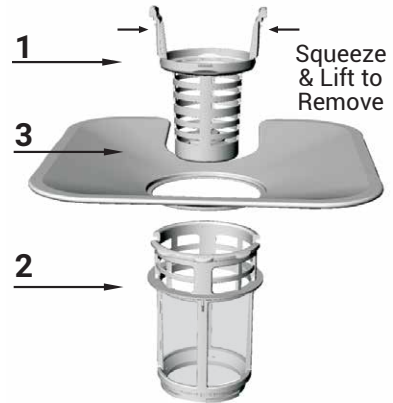

Cleaning:

The filter assembly efficiently removes food particles from the wash water, allowing it to be recirculated during the cycle. For best performance and dishwashing results, it is therefore recommended to inspect and clean the filter assembly for any obstructions or residue after every wash cycle once the dishwasher has cooled.

1. For everyday cleaning, slide the Lower Rack forward and then remove the Coarse Filter by gently squeezing the tabs located at the top of the filter and lifting out of the Micro Filter (See previous image). Remove debris, rinse under running water, and reinsert.

2. For thorough cleaning, rotate the Micro Filter (with Coarse Filter still inserted) counterclockwise to release and lift out of the base of the dishwasher. Remove Coarse Filter as per Step 1 above.



3. Remove the Flat Filter by lifting up.

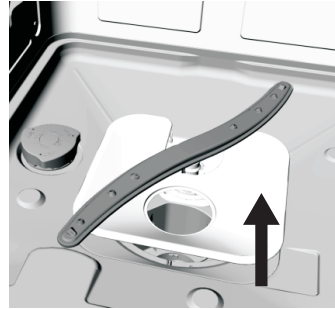

4. Rinse the 3 filter parts under running water. Use a small kitchen brush or toothbrush to clean the fine holes of filters.

Warning: When cleaning the filters, don't bang or knock them to clean; otherwise, the filters could become contorted and the performance of dishwasher could be compromised.

5. To reassemble, position the Flat Filter over the filter hole at the base of the dishwasher. Insert the Coarse Filter back into the Micro Filter by pushing in until tabs are securely positioned. Then, reinsert the Micro Filter back into the filter hole, pressing downwards and turning clockwise to secure.

Note: Do not reinsert the Micro Filter upside down.

6. Thorough cleaning of the filter assembly should be carried out once a week with regular use of the dishwasher.

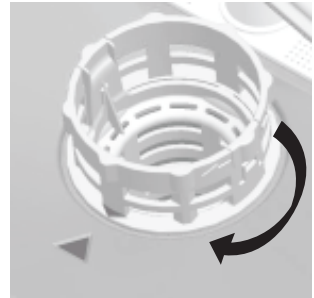

WARNING: THE DISHWASHER MUST NEVER BE USED WITHOUT THE FILTERS. IMPROPER REPLACEMENT OF THE FILTER MAY REDUCE THE PERFORMANCE LEVEL OF THE APPLIANCE AND DAMAGE DISHES AND UTENSILS.

CLEANING THE SPRAY ARMS

It is necessary to clean the spray arms regularly as hard water chemicals will clog the spray arm jets and bearings.

To remove the top spray arm, unscrew the lock nut clockwise and pull the spray arm down to release. To remove the bottom spray arm, grasp the middle and pull up out of the socket with a little force.

Wash the arms under running warm water and use a soft brush to clean the jets. Ensure there are no blockages in the jet holes.

Carefully reinstall the spray arms, making sure the rotary movement is in no way impeded.

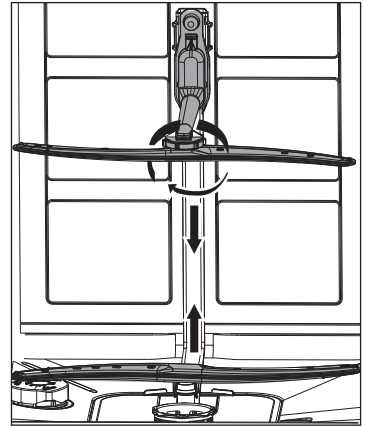
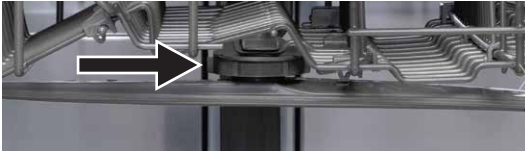

INTERIOR

To remove spots or stains from the interior surfaces, use a water dampened cloth and a little white vinegar, or a cleaning product made specifically for dishwashers.

EXTERIOR

To clean the control panel and door frame, wipe with a lightly dampened cloth then dry thoroughly. Never use a spray cleaner of any kind for it could damage the door lock and electrical components.

To clean the exterior surface, use a damp cloth with warm water or spray suitable for dishwasher surfaces. Never use sharp objects, scouring pads (metal or plastic), abrasive cleaners, or abrasive cloths/paper towels for risk of scratching or leaving marks on the surface.

SEALS

One of the factors that cause odors to form in the dishwasher is food that remains trapped within the door seals. Clean periodically with a damp sponge. Do not use abrasive substances or scouring pads that could affect the seal.

PROTECT AGAINST FREEZING

If your dishwasher is to be left in an unheated location during the winter, we recommend the following steps be taken, with the assistance of a service professional:

1. Disconnect the electrical power to the dishwasher.
2. Turn off the water supply and disconnect the water supply hose from the water valve.
3. Drain water from the inlet hose and water valve. (Use a container to collect draining water)
4. Reconnect the water supply hose to the water valve.
5. Remove the filter assembly from the interior base of the dishwasher and use a sponge to soak up water in the sump area.

GENERAL CARE RECOMMENDATIONS

- After every wash, turn off the water supply to the appliance and leave the door slightly ajar so that moisture and odors are not trapped inside.
- Never use harsh chemicals to clean your dishwasher. Some chloride-containing products can damage your dishwasher and may present health hazards!
- Never use steam cleaning products to clean your dishwasher. The manufacturer will not be responsible for the possible damages or consequences.
- If you do not intend to use the dishwasher for an extended period of time, it is recommended that you run a wash cycle with the dishwasher empty and then remove the power plug from the socket, turn off the water supply and leave the door of the appliance slightly ajar. This will help the seals last longer and prevent odors from forming in the appliance.
- If the appliance must be moved, try to keep it in the vertical position. If absolutely necessary, it can be positioned on its back.

TROUBLESHOOTING TIPS

ERROR CODES

When some malfunctions happen, the appliance will display error codes to warn you.

CODES	MEANINGS	POSSIBLE CAUSE
E1	Door open	The door is opened when the dishwasher is operating
E2	Water inlet	Water inlet malfunction
E3	Water drainage	Water drainage malfunction
E4	Temperature sensor	Temperature sensor malfunction
E5	Overflow/leakage	Overflow occurs/Water leakage occurs
E6	Water leakage	Water leakage occurs
E7	Heating element	Abnormal heating

WARNING: If overflow occurs, turn off the main water supply before calling for service. If there is water in the base interior of the dishwasher because of an overflow or small leak, the water should be removed before restarting the dishwasher.

BEFORE CALLING FOR SERVICE

Review the following troubleshooting guide to assist prior to calling for professional service.

PROBLEM	POSSIBLE CAUSES	WHAT TO DO
Dishwasher doesn't run	Fuse blown, or the circuit breaker acted	Replace fuse or reset circuit breaker. Remove any other appliances sharing the same circuit with the dishwasher.
	Power supply is not turned on	Make sure the dishwasher is turned on and the door is closed securely. Make sure the power cord is properly plugged into the wall socket.
	Water pressure is low	Check that the water supply is connected properly and the water is turned on.
Drain pump doesn't stop	Overflow	The system is designed to detect an overflow. When it does, it shuts off the circulation pump and turns on the drain pump.
Noise	Some audible sounds are normal	Sound from detergent cup opening.
	Utensils are not secure in the baskets or something small has dropped into the basket	Ensure everything is secured in the dishwasher.
	Motor hums	Dishwasher has not been used regularly. If you do not use it often, remember to set it to fill and pump out every week, which will help keep the seal moist.
Suds in the tub	Improper detergent	Use only specialized dishwasher detergent to avoid suds. If suds occurs, open the dishwasher and let suds evaporate. Add 1 gallon of cold water to the tub. Close and latch the dishwasher, then start the "pre-rinse" wash cycle to drain out the water. Repeat if necessary.
	Spilled rinse agent	Always wipe up rinse agent spills immediately.
Stained tub interior	Detergent with colorant was used	Make sure that the detergent is one without colorant.
Dishes and flatware not clean	Improper program	Select a stronger program.
	Improper basket loading	Make sure that the action of the detergent dispenser and spray arms are not blocked by large dishware.
Spots and filming on glasses and flatware	<ol style="list-style-type: none"> 1. Extremely hard water 2. Low inlet temperature 3. Overloading the dishwasher 4. Improper loading 5. Old or damp powder detergent 6. Empty rinse agent dispenser 7. Incorrect dosage of detergent 8. Use of tablet with short cycles 	<p>To remove spots from glassware:</p> <ol style="list-style-type: none"> 1. Take out all metal utensils out of the dishwasher. 2. Do not add detergent. 3. Choose the longest cycle. 4. Start the dishwasher and allow it to run for about 18 to 22 minutes, then it will be in the main wash. 5. Open the door to pour 2 cups of white vinegar into the bottom of the dishwasher. 6. Close the door and let the dishwasher complete the cycle. If the vinegar does not work: Repeat as above, except use 1/4 cup (60 ml) of citric acid crystals instead of vinegar.
Cloudiness on glassware	Combination of soft water and too much detergent	Use less detergent if you have soft water and select a short cycle to wash the glassware. Avoid using tablets/pods.

PROBLEM	POSSIBLE CAUSES	WHAT TO DO
Yellow or brown film on inside surfaces	Tea or coffee stains	Use a solution of 1/2 cup of bleach and 3 cups of warm water to remove the stains by hand. Wear cleaning gloves. WARNING: Wait for 20 minutes after a cycle to let the heating elements cool down before cleaning the interior; otherwise, burns will happen.
	Iron deposits in water can cause an overall film	Contact a water softener company for a specialized filter.
White film on inside surface	Hard water minerals	To clean the interior, use a damp sponge with dishwasher detergent and wear rubber gloves. Use white vinegar to spot clean or a specialized dishwasher cleaner. Never use any other cleaner for the risk of foaming or suds.
The detergent dispenser lid cannot be closed properly	Clogged detergent residue is blocking the catch	Clean the detergent dispenser and catch thoroughly. Avoid using tablets/pods for short programs.
Detergent left in dispenser cups	Dishes block detergent Cups	Re-load the dishes properly.
	Use of tablet/pods	Only use tablets/pods for Heavy, Normal & Delicate programs.
Steam	Normal phenomenon	There is some steam coming through the vent by the door latch during drying and water draining.
Black or gray marks on dishes	Aluminum utensils have rubbed against dishes	Use a mild abrasive cleaner to eliminate those marks.
Water sitting on the bottom of the tub	This is normal	A small amount of clean water around the outlet on the tub bottom keeps the water seal lubricated.
Dishwasher leaks	Overfill dispenser or rinse aid spills	Be careful not to overfill the rinse aid dispenser. Spilled rinse aid could cause excess suds and lead to overflowing. Wipe away any spills with a damp cloth.
	Dishwasher is not level	Make sure the dishwasher is level.

SPECIFICATIONS

Rated Power: 120V~60Hz

12 Place Setting Capacity

ENERGY STAR Certified

UL Listed



Your purchase comes with a 100% satisfaction guarantee from Müller

If you are not happy with the product for any reason, please contact us at support@muellerdirect.com or **888-632-9981** with your feedback or questions, and we will do our best to make things right for you!

Müller USA

168 Mason Way Unit #4A,
City of Industry, CA 91746

Telephone: (888) 632-9981

E-mail: support@muellerdirect.com

Web: www.muellerdirect.com