

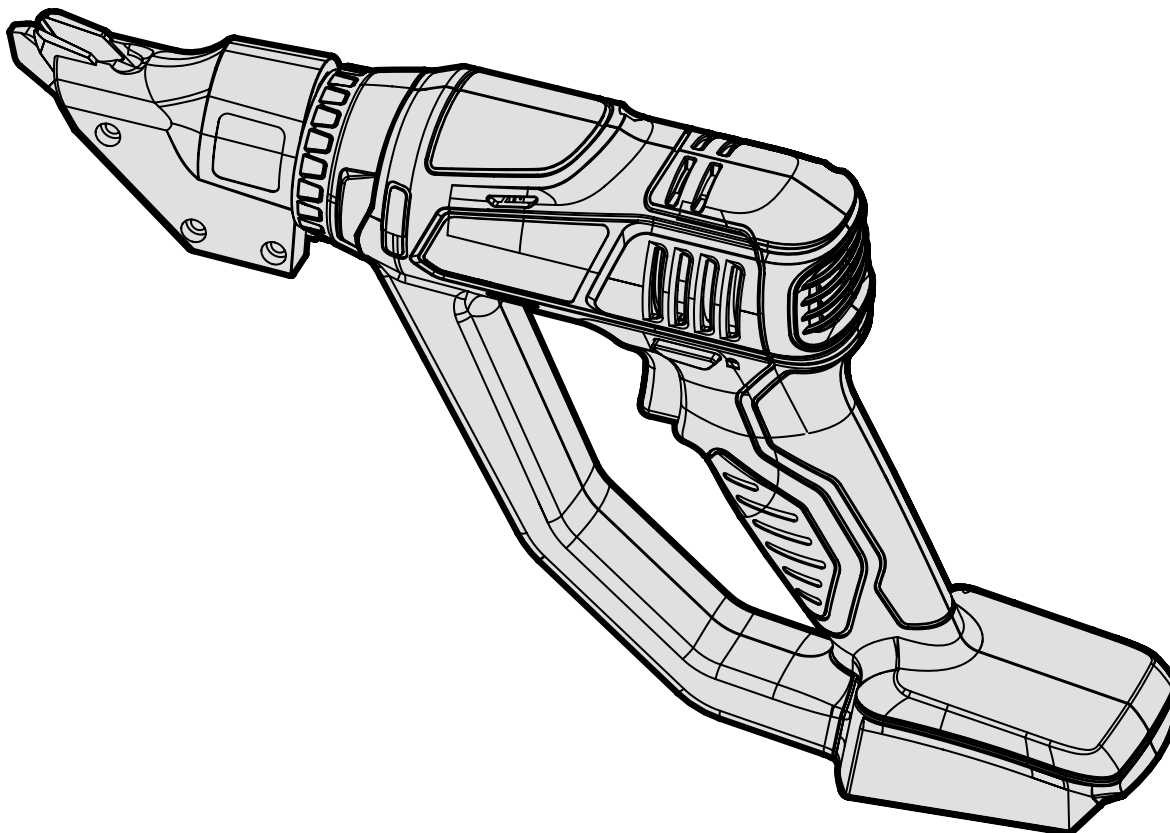

MODEL 20314, 20314BT

20V CORDLESS METAL CUTTING SHEARS

Instruction Manual



NEED HELP? CONTACT US!

Have product questions? Need technical support? Please feel free to contact us:



1-800-232-1195 (M-F 8AM-5PM CST)



TECHSUPPORT@WENPRODUCTS.COM

IMPORTANT: Your new tool has been engineered and manufactured to WEN's highest standards for dependability, ease of operation, and operator safety. When properly cared for, this product will supply you years of rugged, trouble-free performance. Pay close attention to the rules for safe operation, warnings, and cautions. If you use your tool properly and for its intended purpose, you will enjoy years of safe, reliable service.

For replacement parts and the most up-to-date instruction manuals, visit ***WENPRODUCTS.COM***

CONTENTS

WELCOME	3
Introduction	3
Specifications.....	3
SAFETY	4
General Safety Rules.....	4
Metal Cutting Shears Safety Warnings.....	6
Electrical Information.....	8
Battery & Charger Safety Warnings	9
BEFORE OPERATING	11
Unpacking & Packing List.....	11
Know Your Metal Cutting Shears	12
OPERATION & MAINTENANCE	12
Operation	12
Maintenance.....	14
Exploded View & Parts List.....	15
Warranty Statement.....	17

To purchase accessories and replacement parts for your tool, visit **WENPRODUCTS.COM**

20V 2.0Ah Max Battery (Model 20202)

20V 4.0Ah Max Battery (Model 20204)

20V 5.0Ah Max Battery (Model 20205)

20V 2A Charger (Model 20200C)

20V 5A Quick Charger (Model 20201Q)

WEN plans to continue to add more items to our 20V line. For an up-to-date list of the 20V cordless tools compatible with the included battery and charger, visit **wenproducts.com** and search model number 20202 (2Ah) or 20204 (4Ah). In the battery's description, there will be a list of current products that this battery can be used with.

INTRODUCTION

Thanks for purchasing the WEN Metal Cutting Shears. We know you are excited to put your tool to work, but first, please take a moment to read through the manual. Safe operation of this tool requires that you read and understand this operator's manual and all the labels affixed to the tool. This manual provides information regarding potential safety concerns, as well as helpful assembly and operating instructions for your tool.

 Indicates danger, warning, or caution. The safety symbols and the explanations with them deserve your careful attention and understanding. Always follow the safety precautions to reduce the risk of fire, electric shock or personal injury. However, please note that these instructions and warnings are not substitutes for proper accident prevention measures.

NOTE: The following safety information is not meant to cover all possible conditions and situations that may occur. WEN reserves the right to change this product and specifications at any time without prior notice.

At WEN, we are continuously improving our products. If you find that your tool does not exactly match this manual, please visit wenproducts.com for the most up-to-date manual or contact our customer service at **1-800-232-1195**.

Keep this manual available to all users during the entire life of the tool and review it frequently to maximize safety for both yourself and others.

SPECIFICATIONS

Model Number	20314, 20314BT
Included Battery*	2.0Ah Battery (Model 20202)*
Included Charger*	20V, 2A DC (Model 20200C)*
Operating Temperature	0°F - 125°F
Load Speed	0-2500 SPM
Cutting Speed	18 ft/min
Blade Type	Double Cut
Minimum Cutting Radius	7 Inches
Cutting Capacity for Steel	2.0mm, 14 Gauge
Cutting Capacity for Stainless Steel	1.2mm, 18 Gauge
Product Weight	3.91 Pounds (Without Battery) 5.4 Pounds(With Battery)
Product Dimensions	17 in. x 8 in. x 3 in.
Battery Models	All WEN 20V MAX Batteries**
Charger Models	All WEN 20V MAX Chargers

***NOTE:** Battery and charger only included with model 20314. Model 20314BT does not include a battery or charger.

****NOTE:** Some tools may not be compatible with WEN 20V MAX 1.5Ah Batteries, model 49120B. Contact WEN customer service at **1-800-232-1195**, M-F with questions.

GENERAL SAFETY RULES

 **WARNING!** Read all safety warnings and all instructions. Failure to follow the warnings and instructions may result in electric shock, fire and/or serious injury.

Safety is a combination of common sense, staying alert and knowing how your item works. The term “power tool” in the warnings refers to your mains-operated (corded) power tool or battery-operated (cordless) power tool.

SAVE THESE SAFETY INSTRUCTIONS.

WORK AREA SAFETY

- 1. Keep work area clean and well lit.** Cluttered or dark areas invite accidents.
- 2. Do not operate power tools in explosive atmospheres, such as in the presence of flammable liquids, gases or dust.** Power tools create sparks which may ignite the dust or fumes.
- 3. Keep children and bystanders away while operating a power tool.** Distractions can cause you to lose control.

ELECTRICAL SAFETY

- 1. Power tool plugs must match the outlet. Never modify the plug in any way. Do not use any adapter plugs with earthed (grounded) power tools.** Unmodified plugs and matching outlets will reduce risk of electric shock.
- 2. Avoid body contact with earthed or grounded surfaces such as pipes, radiators, ranges and refrigerators.** There is an increased risk of electric shock if your body is earthed or grounded.
- 3. Do not expose power tools to rain or wet conditions.** Water entering a power tool will increase the risk of electric shock.
- 4. Do not abuse the cord. Never use the cord for carrying, pulling or unplugging the power tool. Keep cord away from heat, oil, sharp edges or moving parts.** Damaged or entangled cords increase the risk of electric shock.
- 5. When operating a power tool outdoors, use an extension cord suitable for outdoor use.** Use of a cord suitable for outdoor use reduces the risk of electric shock.

- 6. If operating a power tool in a damp location is unavoidable, use a ground fault circuit interrupter (GFCI) protected supply.** Use of a GFCI reduces the risk of electric shock.

PERSONAL SAFETY

- 1. Stay alert, watch what you are doing and use common sense when operating a power tool. Do not use a power tool while you are tired or under the influence of drugs, alcohol or medication.** A moment of inattention while operating power tools may result in serious personal injury.
- 2. Use personal protective equipment. Always wear eye protection.** Protective equipment such as a respiratory mask, non-skid safety shoes and hearing protection used for appropriate conditions will reduce the risk of personal injury.
- 3. Prevent unintentional starting. Ensure the switch is in the off-position before connecting to power source and/or battery pack, picking up or carrying the tool.** Carrying power tools with your finger on the switch or energizing power tools that have the switch on invites accidents.
- 4. Remove any adjusting key or wrench before turning the power tool on.** A wrench or a key left attached to a rotating part of the power tool may result in personal injury.
- 5. Do not overreach. Keep proper footing and balance at all times.** This enables better control of the power tool in unexpected situations.
- 6. Dress properly. Do not wear loose clothing or jewelry. Keep your hair and clothing away from moving parts.** Loose clothes, jewelry or long hair can be caught in moving parts.

GENERAL SAFETY RULES

 **WARNING!** Read all safety warnings and all instructions. Failure to follow the warnings and instructions may result in electric shock, fire and/or serious injury.

Safety is a combination of common sense, staying alert and knowing how your item works. The term “power tool” in the warnings refers to your mains-operated (corded) power tool or battery-operated (cordless) power tool.

SAVE THESE SAFETY INSTRUCTIONS.

7. If devices are provided for the connection of dust extraction and collection facilities, ensure these are connected and properly used. Use of dust collection can reduce dust-related hazards.

POWER TOOL USE AND CARE

1. Do not force the power tool. Use the correct power tool for your application. The correct power tool will do the job better and safer at the rate for which it was designed.

2. Do not use the power tool if the switch does not turn it on and off. Any power tool that cannot be controlled with the switch is dangerous and must be repaired.

3. Disconnect the plug from the power source and/or the battery pack from the power tool before making any adjustments, changing accessories, or storing power tools. Such preventive safety measures reduce the risk of starting the power tool accidentally.

4. Store idle power tools out of the reach of children and do not allow persons unfamiliar with the power tool or these instructions to operate the power tool. Power tools are dangerous in the hands of untrained users.

5. Maintain power tools. Check for misalignment or binding of moving parts, breakage of parts and any other condition that may affect the power tool's operation. If damaged, have the power tool repaired before use. Many accidents are caused by poorly maintained power tools.

6. Keep cutting tools sharp and clean. Properly maintained cutting tools with sharp cutting edges are less likely to bind and are easier to control.

7. Use the power tool, accessories and tool bits, etc. in accordance with these instructions, taking into account the working conditions and the work to be performed. Use of the power tool for operations different from those intended could result in a hazardous situation.

8. Use clamps to secure your workpiece to a stable surface. Holding a workpiece by hand or using your body to support it may lead to loss of control.

9. KEEP GUARDS IN PLACE and in working order.

SERVICE

1. Have your power tool serviced by a qualified repair person using only identical replacement parts. This will ensure that the safety of the power tool is maintained.

CALIFORNIA PROPOSITION 65 WARNING

Some dust created by power sanding, sawing, grinding, drilling, and other construction activities may contain chemicals, including lead, known to the State of California to cause cancer, birth defects, or other reproductive harm. Wash hands after handling. Some examples of these chemicals are:

- Lead from lead-based paints.
- Crystalline silica from bricks, cement, and other masonry products.
- Arsenic and chromium from chemically treated lumber.

Your risk from these exposures varies depending on how often you do this type of work. To reduce your exposure to these chemicals, work in a well-ventilated area with approved safety equipment such as dust masks specially designed to filter out microscopic particles.

METAL CUTTING SHEARS SAFETY WARNINGS

 **WARNING!** Do not operate the power tool until you have read and understood the following instructions and the warning labels.

METAL CUTTING SHEARS SAFETY

1. Tool purpose. Use the power tool, accessories, and cutting tools, etc., as intended. Using the power tool in ways it was not intended for can lead to potentially hazardous situations.

2. Work environment. Do not operate the tool in wet or damp conditions; doing so significantly increases the risk of electrical shock. Do not operate the tool in the presence of flammable liquids or gases; sparks generated by the grinder could ignite these flammable materials.

3. Personal Safety. Always wear ANSI Z87.1-approved glasses with side shields, hearing protection, and a dust mask when using the metal cutting shears. Tie back long hair. Do not wear loose clothing or jewelry as they might get drawn in by the tool.

4. Tool and accessory inspection. Before operation, check the tool and accessories for any damage or missing parts. Do not use the tool if any part is missing or damaged. Make sure all adjustments are correct and all connections are tight. Keep all guards in place.

5. Preventing electric shock. Hold your power tool by the insulated gripping surfaces, especially when performing an operation where the accessory could contact hidden wiring. Contact with a “live” wire will make exposed metal parts of the tool “live” and shock the operator.

6. Securing the workpiece. Secure any loose workpieces using vises or clamps to prevent wobble, damage to the workpiece, and personal injury.

7. Starting the tool. Hold the tool with both hands in front and away from you. Place the blades of the metal shears onto the workpiece and then smoothly press the power trigger and start cutting.

8. During operation. To prevent personal injury, maintain a firm grip on the tool with both hands. Keep hands, hair, and other beloved body parts away from the rotating components of the tool.

9. Turning off the tool. Lift the tool from the workpiece before turning the machine off. Do not lay the tool down until it has come to a complete stop. Do not touch the pad or the workpiece immediately after operation. They may be extremely hot and could burn your skin.

10. Making adjustments. Always turn off and remove the battery from the tool before cleaning, making adjustments, or changing attachments. Accidental start-ups may occur if the tool has power during an accessory change or adjustment.

11. Storing the power tool. Store the shears, when not in use, out of the reach of children and do not allow people who are not familiar with the tool or these instructions to operate it.

12. Maintain power tools. Check for misalignment or jammed moving parts, breakages, or any other feature that might affect the operation of the metal cutting shears. If it is damaged, the power tool must be repaired by a professional.

13. Keep cutting tools sharp and clean. Properly maintained cutting tools with sharp cutting edges are less likely to jam and are easier to control.

METAL CUTTING SHEARS SAFETY WARNINGS

 **WARNING!** Do not operate the power tool until you have read and understood the following instructions and the warning labels.

REDUCING KICKBACK

Kickback is a sudden reaction to a pinched or snagged rotating grinding wheel or any other accessory. Pinching or snagging causes rapid stalling of the rotating accessory which in turn causes the uncontrolled power tool to be jump toward or away from the operator, depending on direction of the wheel's movement at the point of pinching. Take proper safety prevention methods to reduce the risk of kickback:

1. Maintain a firm grip on the power tool and position your body and arm to allow you to resist kickback forces. The operator can control torque reactions or kickback forces, if proper precautions are taken.
2. Never place your hand near a moving accessory. Accessories may kick back over your hand.
3. Do not position your body in the area where the power tool will move if kickback occurs. Kickback will propel the tool in direction opposite to the wheel's movement at the point of snagging.
4. Use special care when working corners, sharp edges etc. Avoid bouncing and snagging the shears. Corners or sharp edges have the tendency to snag the rotating shears and cause loss of control or kickback.

VIBRATION SAFETY

This tool vibrates during use. Repeated or long-term exposure to vibration may cause temporary or permanent physical injury, particularly to the hands, arms and shoulders. To reduce the risk of any vibration-related injury:

1. First be examined by a doctor and then have regular medical check-ups to ensure medical problems are not being caused or worsened from use. Pregnant women or people who have impaired blood circulation to the hand, past hand injuries, nervous system disorders, diabetes, or Raynaud's disease should not use this tool. If you feel any symptoms related to vibration (such as tingling, numbness, and white or blue fingers), seek medical advice as soon as possible.
2. Do not smoke during use. Nicotine reduces the blood supply to the hands and fingers, increasing the risk of vibration-related injury.
3. Wear suitable gloves to reduce the effects of vibration.
4. Use tools with the lowest vibration when there is a choice.
5. Take vibration-free breaks during each day of work.
6. To reduce vibration, maintain the tool as explained in this manual. If any abnormal vibration occurs, stop using the tool immediately.

ELECTRICAL INFORMATION (CHARGER)

DOUBLE-INSULATED CHARGER

The charger's electrical system is double-insulated where two systems of insulation are provided. This eliminates the need for the usual three-wire grounded power cord. Double-insulated tools do not need to be grounded, nor should a means for grounding be added to the product. All exposed metal parts are isolated from the internal metal components with protecting insulation.

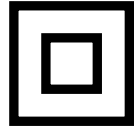

IMPORTANT: Servicing a double-insulated product requires extreme care and knowledge of the system, and should be done only by qualified service personnel using identical replacement parts. Always use original factory replacement parts when servicing.

1. Polarized Plugs. To reduce the risk of electric shock, this equipment has a polarized plug (one blade is wider than the other). This plug will fit in a polarized outlet only one way. If the plug does not fit fully in the outlet, reverse the plug. If it still does not fit, contact a qualified electrician to install a proper outlet. Do not modify the machine plug or the extension cord in any way.

2. Ground fault circuit interrupter protection (GFCI) should be provided on the circuit or outlet used for this power tool to reduce the risk of electric shock.

3. Service and repair. To avoid danger, electrical appliances must only be repaired by a qualified service technician using original replacement parts.

GUIDELINES AND RECOMMENDATIONS FOR EXTENSION CORDS

When using an extension cord, be sure to use one heavy enough to carry the current your product will draw. An undersized cord will cause a drop in line voltage, resulting in loss of power and overheating. The table below shows the correct size to be used according to cord length and ampere rating. When in doubt, use a heavier cord. The smaller the gauge number, the heavier the cord.

AMPERAGE	REQUIRED GAUGE FOR EXTENSION CORDS			
	25 ft.	50 ft.	100 ft.	150 ft.
2A	18 gauge	16 gauge	16 gauge	14 gauge

1. Examine extension cord before use. Make sure your extension cord is properly wired and in good condition. Always replace a damaged extension cord or have it repaired by a qualified person before using it.

2. Do not abuse extension cord. Do not pull on cord to disconnect from receptacle; always disconnect by pulling on plug. Disconnect the extension cord from the receptacle before disconnecting the product from the extension cord. Protect your extension cords from sharp objects, excessive heat and damp/wet areas.

3. Use a separate electrical circuit for your tool. This circuit must not be less than a 12-gauge wire and should be protected with a 15A time-delayed fuse.

BATTERY & CHARGER SAFETY WARNINGS

Despite all of the safety precautions, caution must always be taken when handling batteries. The following points must be obeyed at all times to ensure safe use. Safe use can only be guaranteed if undamaged cells are used. Incorrect handling of the battery pack can cause cell damage.

- **Avoid dangerous environments** – Do not charge the battery pack in rain, snow or in damp or wet locations. Do not use the battery pack or charger in the presence of explosive atmospheres (gaseous fumes, dust or flammable materials) because sparks may be generated when inserting or removing the battery pack, which could lead to a fire.

- **Charge in a well-ventilated area** – Do not block the charger vents. Keep them clear to allow for proper ventilation. Do not allow smoking or open flames near a charging battery pack. Vented gases may explode.

NOTE: The safe temperature range for the battery charging is 41°F to 104°F. Do not charge the battery outside in freezing weather; charge it at room temperature.

- **Maintain charger cord** – When unplugging the charger, pull the plug, not the cord, from the receptacle to reduce the risk of damage to the electrical plug and cord. Never carry the charger by its cord or yank it by the cord to disconnect it from the receptacle. Keep the cord away from heat, oil and sharp edges. Make sure the cord will not be stepped on, tripped over or subjected to damage or stress when the charger is in use. Do not use the charger with a damaged cord or plug. Replace a damaged charger immediately.

- **Do not use an extension cord unless it is absolutely necessary** – Using the wrong, damaged or improperly wired extension cord poses a risk of fire and electric shock. If an extension cord must be used, plug the charger into a properly wired 16 gauge or larger extension cord with the female plug matching the male plug on the charger. Make sure that the extension cord is in good electrical condition.

- **Charger is rated for 120 volt AC only** – The charger must be plugged into an appropriate receptacle.

- **Use only recommended attachments** – Use of an attachment not recommended or sold by WEN Products may result in risk of fire, electric shock or personal injury.

- **Unplug charger when not in use** – Make sure to remove battery packs from unplugged chargers.

 **WARNING!** To reduce the risk of electric shock, always unplug the charger before performing any cleaning or maintenance. Do not allow water to flow into the charger. Use a Ground Fault Circuit Interrupter (GFCI) to reduce shock hazards.

- **Do not burn or incinerate battery packs** – Battery packs may explode, causing personal injury or damage. Toxic fumes and materials are created when battery packs are burned.

- **Do not crush, drop or damage battery packs** – Do not use the battery pack or charger if they have sustained a sharp blow, been dropped, run over or have been damaged in any way (i.e. pierced with a nail, hit with a hammer, stepped on, etc.).

- **Do not disassemble** – Incorrect reassembly may pose a serious risk of electric shock, fire or exposure to toxic battery chemicals. If the battery or charger are damaged, call WEN customer service at **1-800-232-1195** for assistance.

- **Battery chemicals cause serious burns** – Never let a damaged battery pack contact the skin, eyes or mouth. If a damaged battery pack leaks battery chemicals, use rubber or neoprene gloves to safely dispose of it. If skin is exposed to battery fluids, wash the affected area with soap and water and rinse with vinegar. If eyes are exposed to battery chemicals, immediately flush with water for 20 minutes and seek medical attention. Remove and dispose of contaminated clothing.

- **Store your battery pack and charger in a cool, dry place** – Do not store the battery pack or charger where temperatures may exceed 104 °F, such as in direct sunlight or inside a vehicle or metal building during the summer.

- **Do not short circuit** – A battery pack will short circuit if a metal object makes a connection between the positive and negative contacts on the battery pack. Do not place a battery pack near anything that may cause a short circuit, such as paper clips, coins, keys, screws, nails and other metallic objects. A short-circuited battery pack poses a risk of fire and severe personal injury.

BATTERY & CHARGER SAFETY WARNINGS

ABOUT THE BATTERY

1. The battery pack has to be charged completely before you use the tool for the first time.
2. For optimum battery performance, avoid low discharge cycles by charging the battery pack frequently.
3. Lithium-ion batteries are subject to a natural aging process. The battery pack must be replaced at the latest when its capacity falls to just 80% of its capacity when new. Weakened cells in an aged battery pack are no longer capable of meeting the high power requirements needed for the proper operation of your tool, and therefore pose a safety risk.
4. Do not throw battery packs into an open fire as this poses a risk of explosion. Do not ignite the battery pack or expose it to fire.
5. Do not exhaustively discharge batteries. Exhaustive discharge will damage the battery cells. The most common cause of exhaustive discharge is lengthy storage or non-use of partially discharged batteries. Stop working as soon as the performance of the battery falls noticeably or the electronic protection system triggers. Place the battery pack in storage only after it has been fully charged.
6. Protect batteries and the tool from overloads. Overloads will quickly result in overheating and cell damage inside the battery housing even if this overheating is not apparent externally.
7. Avoid damage and shocks. Immediately replace batteries that have been dropped from a height of more than one meter or those that have been exposed to violent shocks, even if the housing of the battery pack appears to be undamaged. The battery cells inside the battery may have suffered serious damage. In such instances, please read the waste disposal information for proper battery disposal.
8. If the battery pack suffers overloading and overheating, the integrated protective cutoff will switch off the equipment for safety reasons.
9. Use only original battery packs. The use of other batteries poses a fire risk and may result in injuries or an explosion.

ABOUT THE CHARGER

Protect battery charger and cord from damage. Keep the charger and its cord away from heat, oil and sharp edges.

Electrical plugs must match the outlet. Never modify the plug in any way. Do not use any adapter plugs with grounded appliances. Unmodified plugs and matching outlets will reduce the risk of electric shock.

Keep the battery charger, battery pack(s), and the cordless tool out of the reach of children.

Do not use the supplied battery charger to charge other cordless tools.

During periods of heavy use, the battery pack will become warm. Allow the battery pack to cool to room temperature before inserting it into the charger to recharge.

Do not overcharge batteries. Do not exceed the maximum charging times. These charging times only apply to discharged batteries. Frequent insertion of a charged or partially charged battery pack will result in overcharging and cell damage. Do not leave battery in the charger for days on end.

Never use or charge a battery if you suspect that it has been more than 12 months since last time they were charged. There is a high probability that the battery pack has already suffered dangerous damage (exhaustive discharge).

Do not use batteries that have been exposed to heat during the charging process, as the battery cells may have suffered dangerous damage.

Do not use batteries that have suffered curvature or deformation during the charging process or those that exhibit other atypical symptoms (gassing, hissing, cracking, etc.)

UNPACKING & PACKING LIST

UNPACKING

Carefully remove the metal cutting shears from the packaging and place it on a sturdy, flat surface. Make sure to take out all contents and accessories. Do not discard the packaging until everything is removed. Check the packing list below to make sure you have all of the parts and accessories. If any part is missing or broken, please contact customer service at **1-800-232-1195** (M-F 8-5 CST), or email techsupport@wenproducts.com.

Components

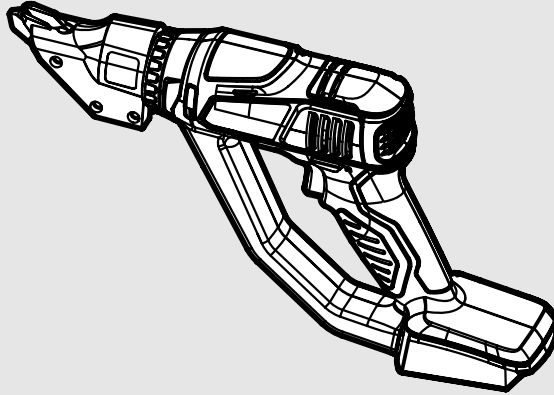

Metal Cutting Shears

Accessories

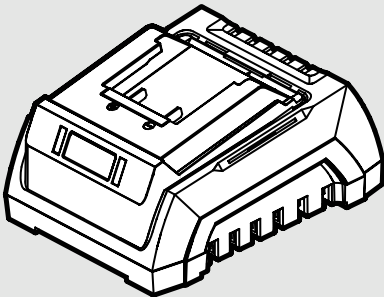

20V Charger (1)*

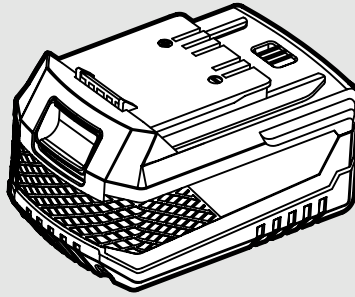

20V Battery (1)*



4mm Hex Wrench (1)

*Only included with model number 20314.

KNOW YOUR METAL CUTTING SHEARS

TOOL PURPOSE

Easily cut through steel and stainless steel with your WEN Metal Cutting Shears. Refer to the following diagrams to become familiarized with all the parts and controls of your shears. The components will be referred to later in the manual for assembly and operation instructions.

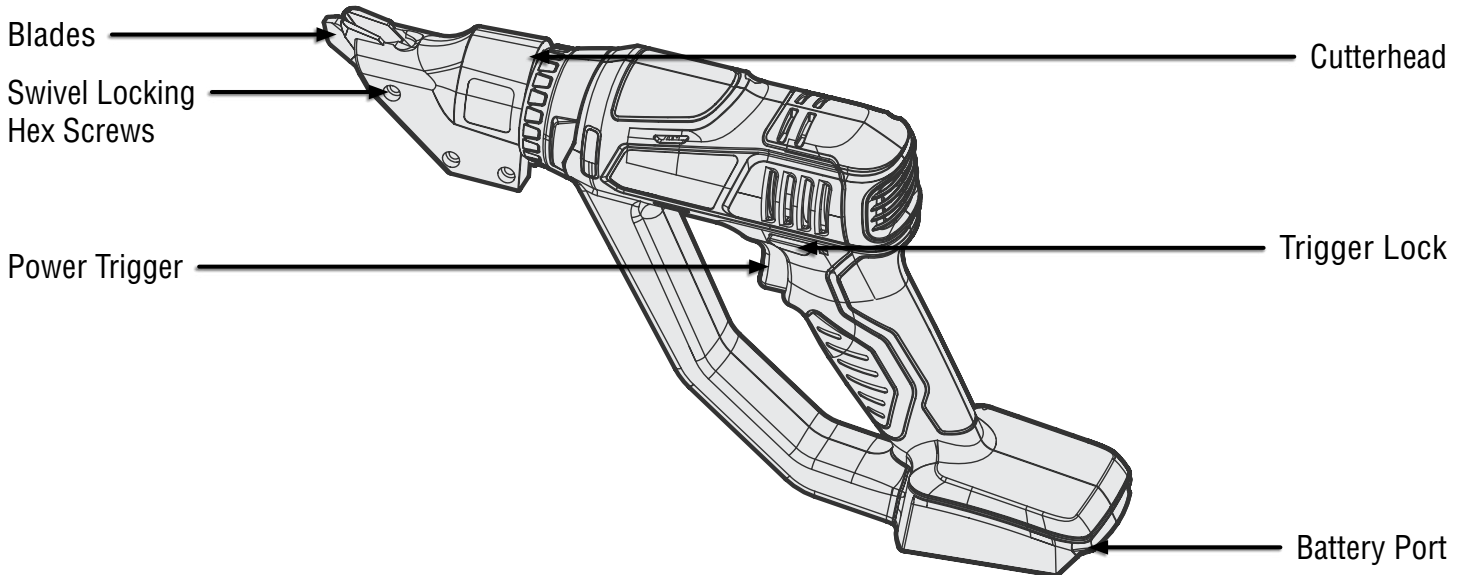

OPERATION

⚠ WARNING! To avoid injury from accidental startups, make sure that the power trigger lock is engaged and the battery is removed from the shears.

NOTE: Maintain the tools with care. This tool requires no additional lubrication. Never use water or chemical cleaner to clean your power tool. Wipe clean with a dry cloth. Always store your power tool in a dry place away from the reach of children. Keep the motor ventilation slots clean and free of debris. Periodically clean dust and metal chips from the guard and base. Occasionally, a small spark may ignite within the ventilation slots. This is a normal result of the carbon brushes and will not damage your tool.

OPERATING THE METAL CUTTING SHEARS

1. Connect the battery to the battery port on the shears. Make sure that the battery has charge.
2. Place the shearing jaws at the edge of a workpiece with the piece of metal running between the blades.

NOTE: Before cutting your workpiece, make some practice cuts on a piece of scrap material to make sure that you can adequately operate the tool.

3. Disengage the trigger lock.
4. Press the power trigger to start the shears. Gradually move the blade through the material following your desired pattern. Never force the tool to do a job that it cannot handle. The scrap chunk being cut should curl up as you cut.
5. Do not lean the shears forward or attempt to force the shears through the workpiece. Keep the flat of the cutter head parallel with the workpiece and the shears at a 45-degree angle.

OPERATION

ADJUSTING THE CUTTERHEAD

The cutterhead of the shears can be rotated up to 360 degrees depending on the requirements of the workpiece at hand.

1. Engage the power trigger lock and remove the battery from the battery port.
2. Loosen the three hex screws found along the edge of the cutterhead (Fig. 1 - 1). Once loosened, rotate the head of the unit to the desired position and retighten the hex screws. Make sure all hex screws are secure before attempting to power and operate the device.

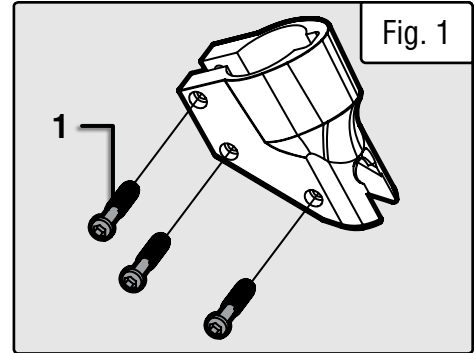

REPLACING THE CUTTING BLADES

After extended use, the cutting blades will become dull and need replacing.

1. Remove the three hex screws (Fig 1 - 1) located around the outer edge of the cutterhead in order to remove the head from the machine. Set them to the side for safe keeping.
2. Carefully remove the three blades, taking note as to the way they are configured (left blade, middle blade, and right blade). Watch for the two spacers (Fig. 2 - 1) included in the blade assembly: one can be found through the neck of the middle blade while the other is threaded through the center hex screw. Make sure not to lose these.

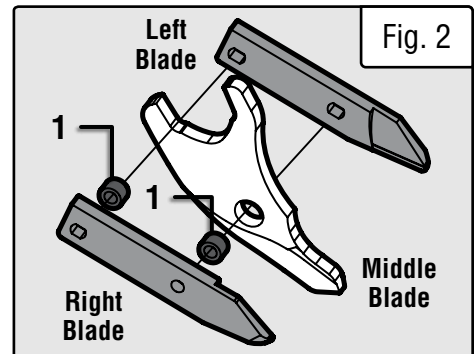

3. Replace the dull blades with new, sharp blades. Place the spacers in as necessary. Once the blades and spacers have been properly aligned within the cutter-head, insert the hex screws. Wait to fully tighten the hex screws until the head has been placed back onto the body of the unit.

MAINTENANCE

 **WARNING!** To avoid accidents, make sure the power switch is in the OFF position and unplug the tool from the electrical outlet before cleaning or performing any maintenance. Servicing of the tool must be performed by a qualified technician.

ROUTINE INSPECTION

1. Before each use, inspect the general condition of the tool.

Check for:

- Loose hardware,
- Misalignment or binding of moving parts,
- Damaged cord/electrical wiring,
- Cracked or broken parts, and
- Any other condition that may affect its safe operation.

2. After every use, wipe the tool with a soft cloth. Do not let water enter the tool.

3. Keep the ventilation openings free from dust and debris to prevent the motor from overheating.

4. Most plastics are susceptible to damage from various types of commercial solvents. Do not use any solvents or cleaning products that could damage the plastic parts. Some of these include but are not limited to: gasoline, carbon tetrachloride, chlorinated cleaning solvents, ammonia and household detergents that contain ammonia.

5. Store the tool in a clean and dry place away from the reach of children.

PRODUCT DISPOSAL

Used power tools should not be disposed of together with household waste. This product contains electronic components that should be recycled. Please take this product to your local recycling facility for responsible disposal and to minimize its environmental impact.

EXPLODED VIEW & PARTS LIST

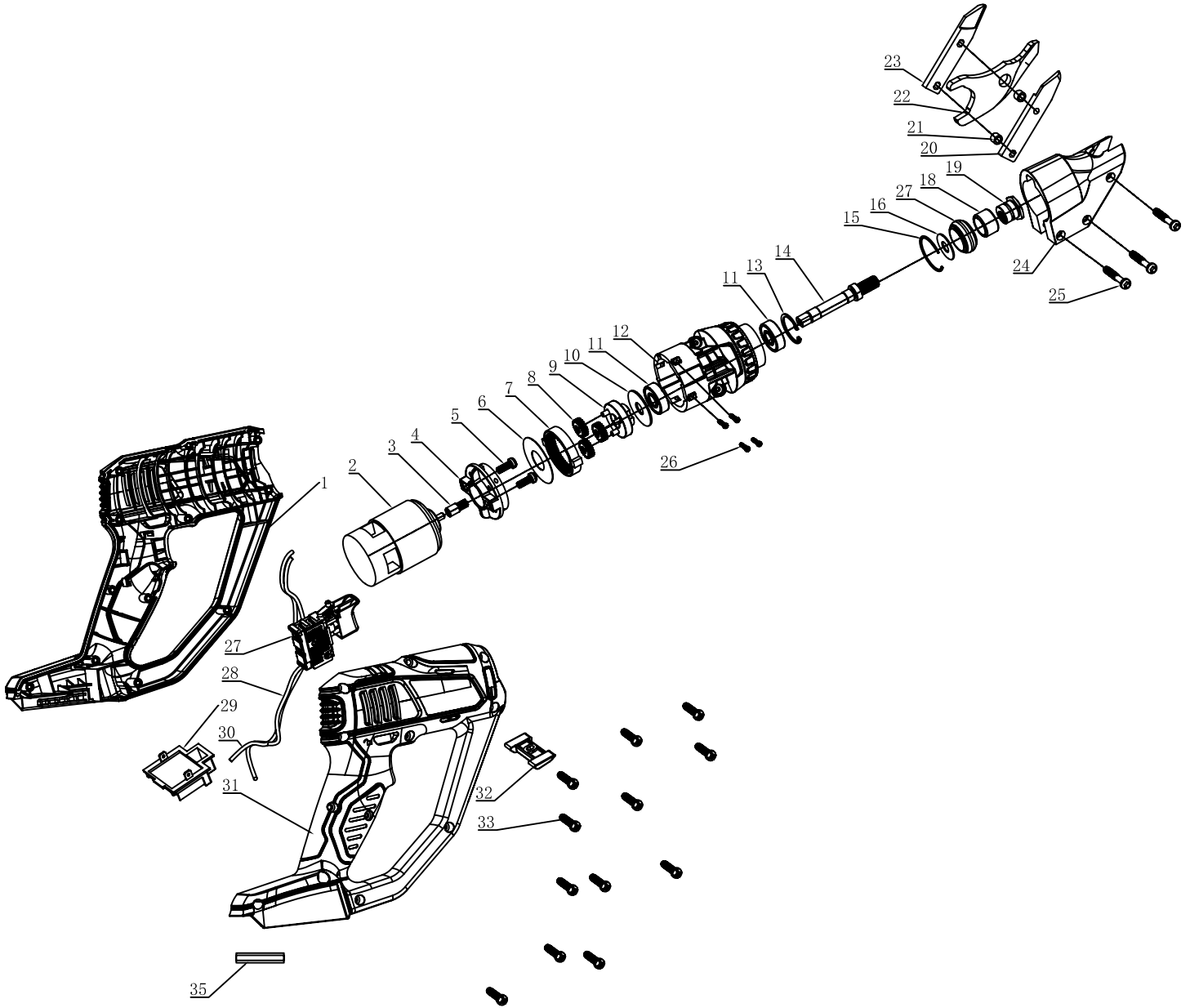

NOTE: Not all parts may be available for purchase. Parts and accessories that wear down over the course of normal use are not covered under the warranty.

EXPLODED VIEW & PARTS LIST

No.	Part No.	Description	Qty.	No.	Part No.	Description	Qty.
1	20314-001	Left Housing	1	18	20314-018	Needle Bearing	1
2	20314-002	Motor	1	19	20314-019	Eccentric Nut	1
3	20314-003	Motor Pinion	1	20	20314-020	Right Blade	1
4	20314-004	Gear Box Cover	1	21	20314-021	Bushing	2
5	20314-005	Screw	2	22	20314-022	Middle Blade	1
6	20314-006	Washer	1	23	20314-023	Left Blade	1
7	20314-007	Ring	1	24	20314-024	Blade Collar	1
8	20314-008	Gear	3	25	20314-025	Screw	3
9	20314-009	Subassembly	1	26	20314-026	Screw	4
10	20314-010	Washer	1	27	20314-027	Switch	1
11	20314-011	Bearing 6000RZ	2	28	20314-028	Internal Wires	1
12	20314-012	Gear Case	1	29	20314-029	Junction Plate	1
13	20314-013	Check Ring	1	30	20314-030	Internal Wires	1
14	20314-014	Output Shaft	1	31	20314-031	Right Housing	1
15	20314-015	Check Ring	1	32	20314-032	Pushrod	1
16	20314-016	Washer	1	33	20314-033	Screw	12
17	20314-017	Bearing Sleeve	1	35	20314-035	Thermoplastic hose	

NOTE: Not all parts may be available for purchase. Parts and accessories that wear down over the course of normal use are not covered under the warranty.

WARRANTY STATEMENT

WEN Products is committed to building tools that are dependable for years. Our warranties are consistent with this commitment and our dedication to quality.

LIMITED WARRANTY OF WEN PRODUCTS FOR HOME USE

GREAT LAKES TECHNOLOGIES, LLC (“Seller”) warrants to the original purchaser only, that all WEN consumer power tools will be free from defects in material or workmanship during personal use for a period of two (2) years from date of purchase or 500 hours of use; whichever comes first. Ninety days for all WEN products if the tool is used for professional or commercial use. Purchaser has 30 days from the date of purchase to report missing or damaged parts.

SELLER’S SOLE OBLIGATION AND YOUR EXCLUSIVE REMEDY under this Limited Warranty and, to the extent permitted by law, any warranty or condition implied by law, shall be the replacement of parts, without charge, which are defective in material or workmanship and which have not been subjected to misuse, alteration, careless handling, misrepair, abuse, neglect, normal wear and tear, improper maintenance, or other conditions adversely affecting the Product or the component of the Product, whether by accident or intentionally, by persons other than Seller. To make a claim under this Limited Warranty, you must make sure to keep a copy of your proof of purchase that clearly defines the Date of Purchase (month and year) and the Place of Purchase. Place of Purchase must be a direct vendor of Great Lakes Technologies, LLC. Purchasing through third party vendors, including but not limited to garage sales, pawn shops, resale shops, or any other secondhand merchant, voids the warranty included with this product. Contact techsupport@wenproducts.com or 1-800-232-1195 with the following information to make arrangements: your shipping address, phone number, serial number, required part numbers, and proof of purchase. Damaged or defective parts and products may need to be sent to WEN before the replacements can be shipped out.

Upon the confirmation of a WEN representative, your product may qualify for repairs and service work. When returning a product for warranty service, the shipping charges must be prepaid by the purchaser. The product must be shipped in its original container (or an equivalent), properly packed to withstand the hazards of shipment. The product must be fully insured with a copy of the proof of purchase enclosed. There must also be a description of the problem in order to help our repairs department diagnose and fix the issue. Repairs will be made and the product will be returned and shipped back to the purchaser at no charge for addresses within the contiguous United States.

THIS LIMITED WARRANTY DOES NOT APPLY TO ITEMS THAT WEAR OUT FROM REGULAR USAGE OVER TIME, INCLUDING BELTS, BRUSHES, BLADES, BATTERIES, ETC. ANY IMPLIED WARRANTIES SHALL BE LIMITED IN DURATION TO TWO (2) YEARS FROM DATE OF PURCHASE. SOME STATES IN THE U.S. AND SOME CANADIAN PROVINCES DO NOT ALLOW LIMITATIONS ON HOW LONG AN IMPLIED WARRANTY LASTS, SO THE ABOVE LIMITATION MAY NOT APPLY TO YOU.

IN NO EVENT SHALL SELLER BE LIABLE FOR ANY INCIDENTAL OR CONSEQUENTIAL DAMAGES (INCLUDING BUT NOT LIMITED TO LIABILITY FOR LOSS OF PROFITS) ARISING FROM THE SALE OR USE OF THIS PRODUCT. SOME STATES IN THE U.S. AND SOME CANADIAN PROVINCES DO NOT ALLOW THE EXCLUSION OR LIMITATION OF INCIDENTAL OR CONSEQUENTIAL DAMAGES, SO THE ABOVE LIMITATION OR EXCLUSION MAY NOT APPLY TO YOU.

THIS LIMITED WARRANTY GIVES YOU SPECIFIC LEGAL RIGHTS, AND YOU MAY ALSO HAVE OTHER RIGHTS WHICH VARY FROM STATE TO STATE IN THE U.S., PROVINCE TO PROVINCE IN CANADA AND FROM COUNTRY TO COUNTRY.

THIS LIMITED WARRANTY APPLIES ONLY TO ITEMS SOLD WITHIN THE UNITED STATES OF AMERICA, CANADA AND THE COMMONWEALTH OF PUERTO RICO. FOR WARRANTY COVERAGE WITHIN OTHER COUNTRIES, CONTACT THE WEN CUSTOMER SUPPORT LINE. FOR WARRANTY PARTS OR PRODUCTS REPAIRED UNDER WARRANTY SHIPPING TO ADDRESSES OUTSIDE OF THE CONTIGUOUS UNITED STATES, ADDITIONAL SHIPPING CHARGES MAY APPLY.

**THANKS FOR
REMEMBERING**

