

Item ID	Front Thickness [in] mm	Door Thickness [in] mm
EH2135B-GB	[.75] 19	[.75] 19

This profile belongs to EH2135B-GB

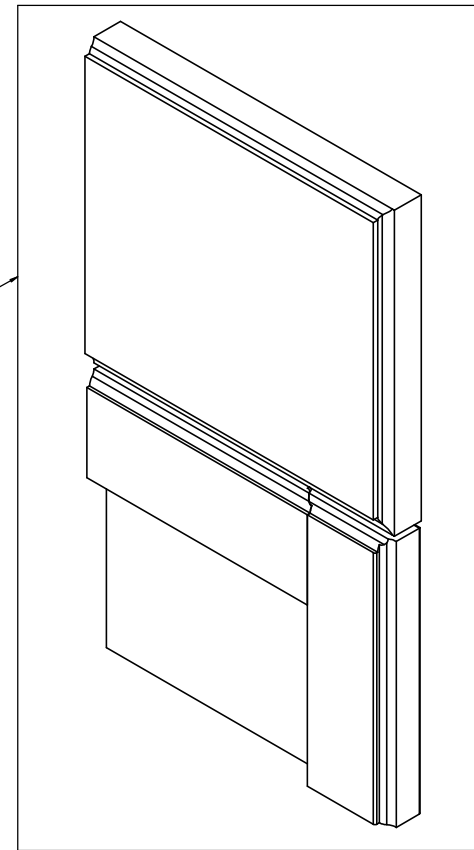
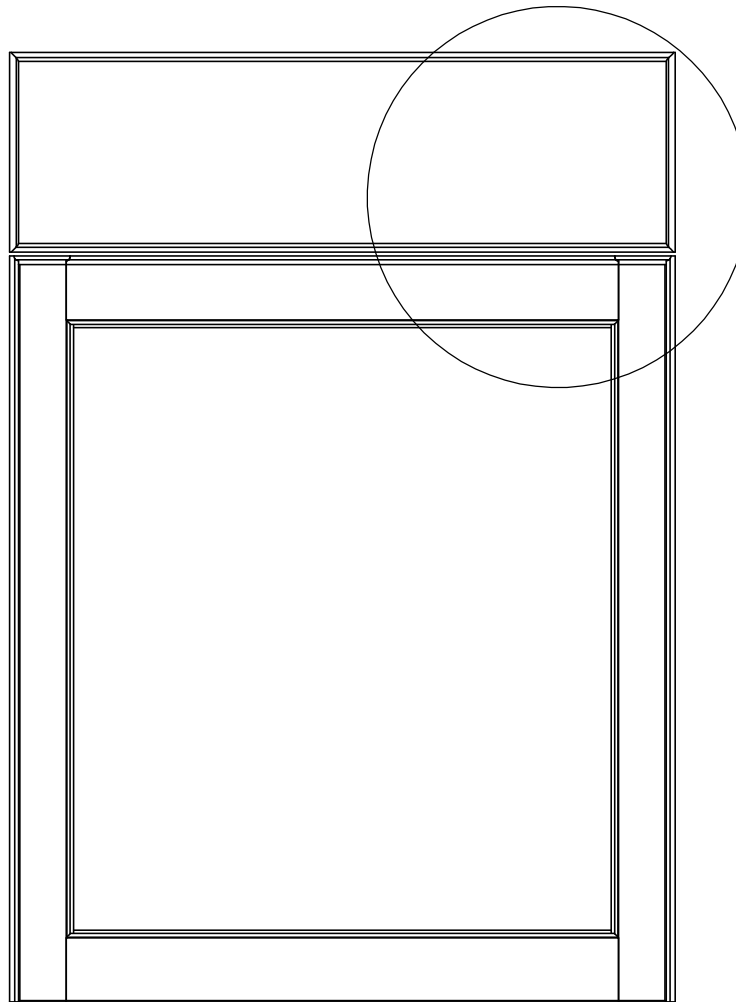

Detailed View

**Profile: Easthaven German Beech**

PROPRIETARY AND CONFIDENTIAL  
 THE INFORMATION CONTAINED IN THIS DRAWING IS THE SOLE PROPERTY OF WOODCRAFTERS. ANY REPRODUCTION IN PART OR AS A WHOLE WITHOUT THE WRITTEN PERMISSION OF WOODCRAFTERS IS PROHIBITED.

UNLESS OTHERWISE SPECIFIED  
 DIMENSIONS ARE IN MM AND [INCHES]  
 TOLERANCES ARE  
 +.039[1]-.039[1]  
 SCALE:1:2



Item ID	Shelf Thickness [in] mm	Shelf Length and Width [in] mm	Depth "X" [in] mm
BT3035B-BT	[.75] 19	L:[10.57] 268.5 W:[28.58] 726	[24.60] 625
BT3035B-WH	[.75] 19		[24.44] 621
CM3035B-DK	[.75] 19		[24.60] 625
CM3035B-WH	[.59] 15		[24.44] 621
EH3035B-GB	[.75] 19		[24.60] 625
BT3035B-RC	[.75] 19		[24.60] 625
CM3035B-KG	[.75] 19		[24.44] 621

Description					
Kitchens - Base Cabinet 30 with Soft Close Full Extension Drawer					
REV	ECO#	Description	REV'D BY DATE	CHK'D BY DATE	APRV'D BY DATE
3		Structural Change	07/25/18	07/25/18	07/25/18

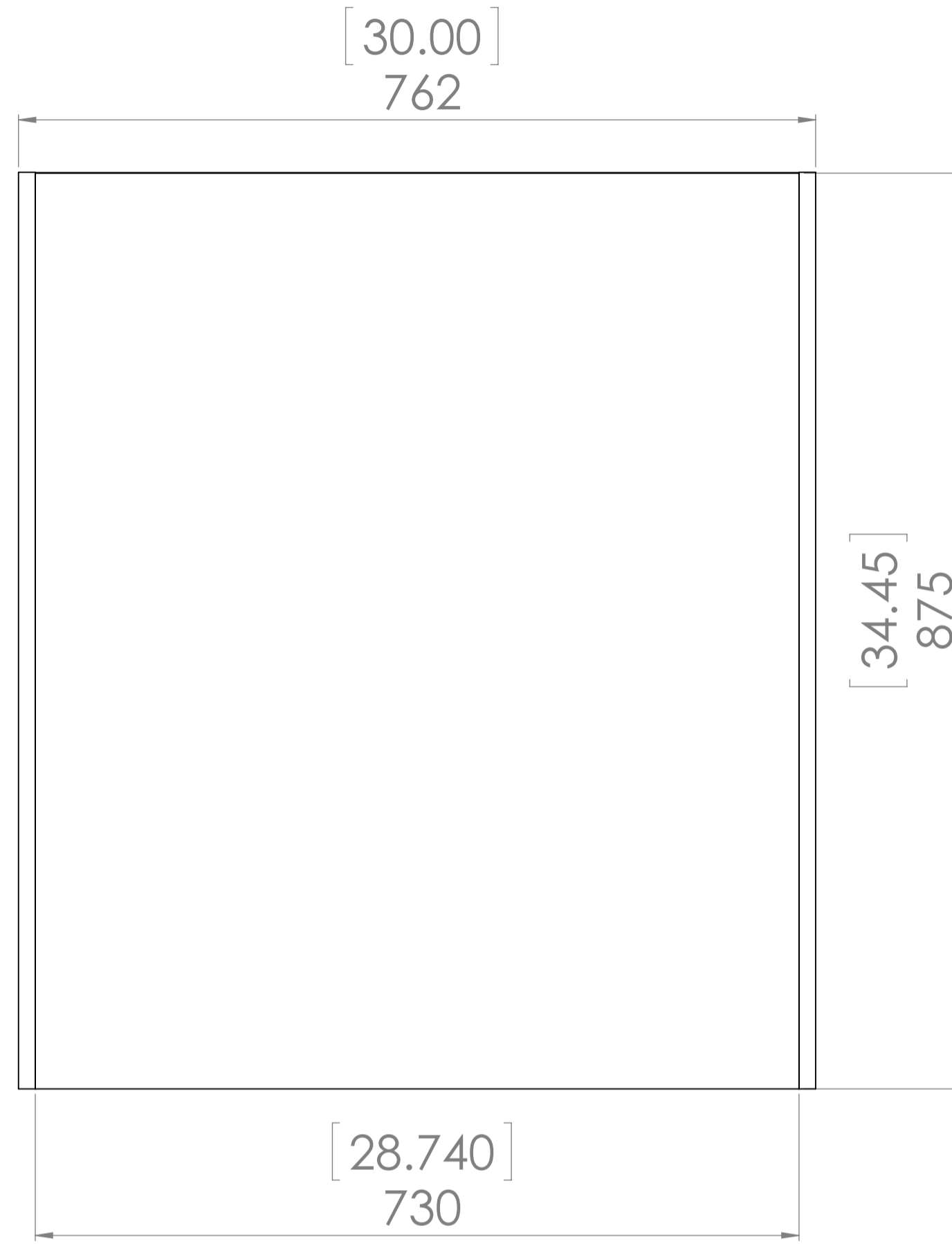

**Back View**

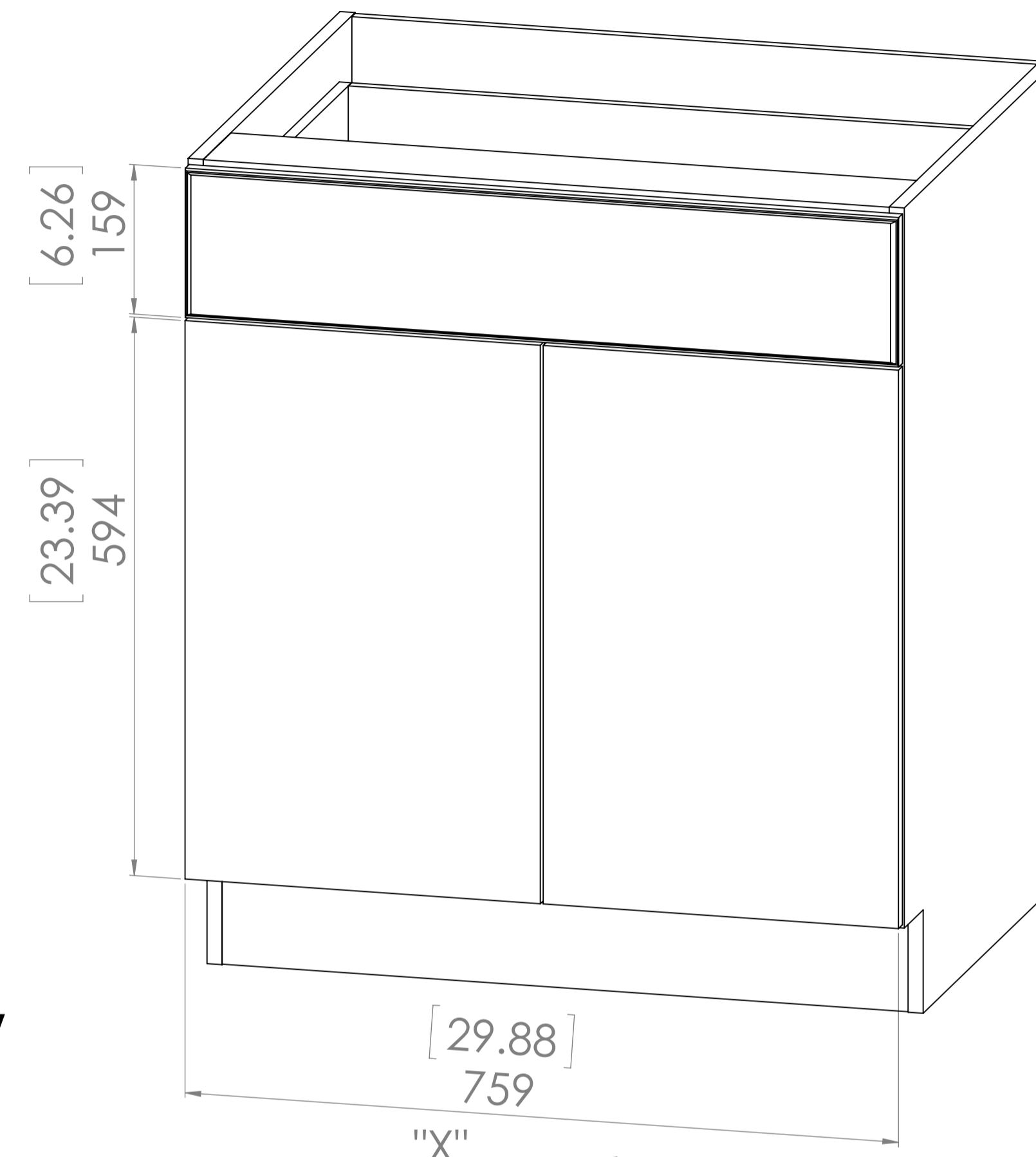

**Isometric View**

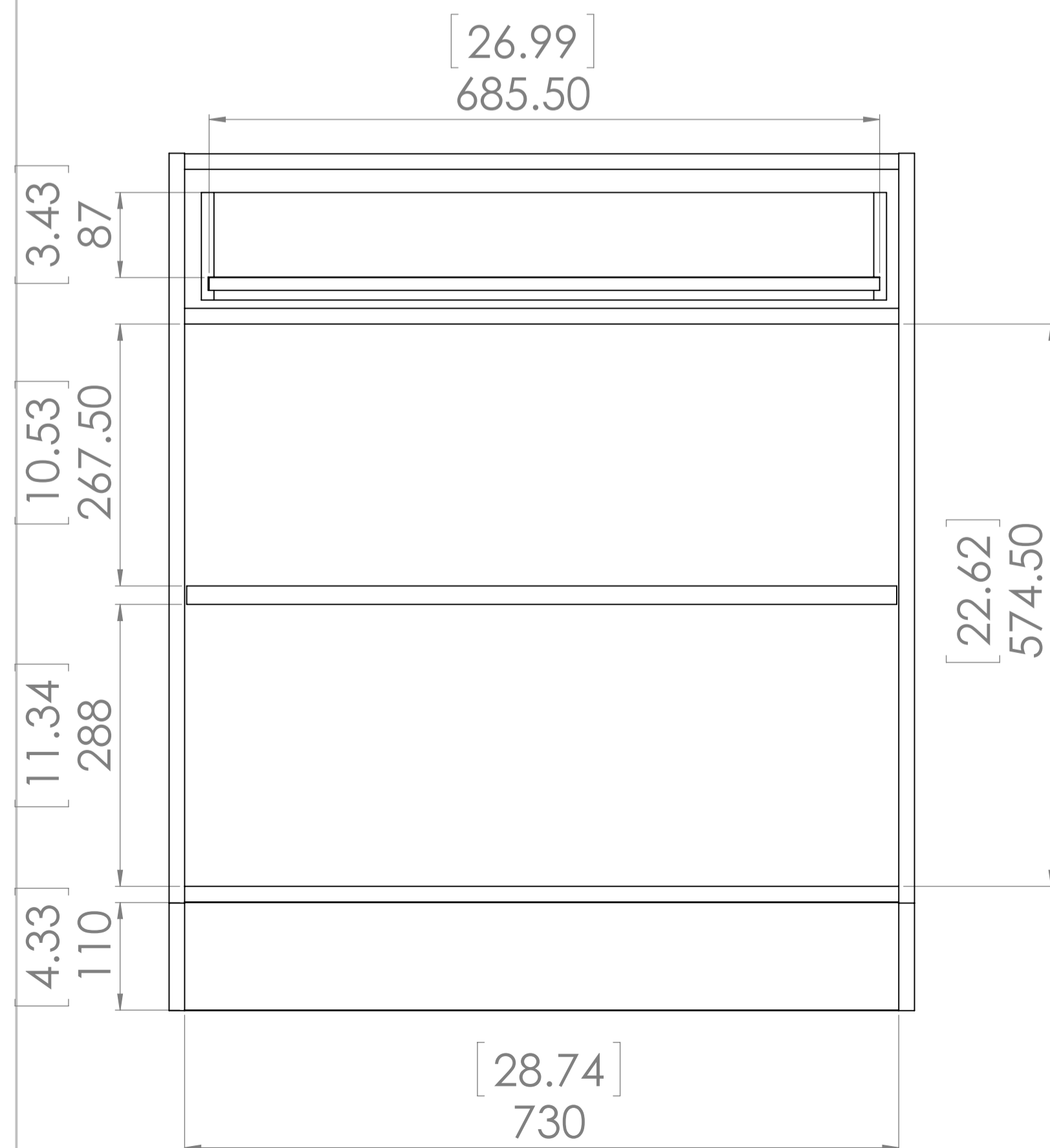

**Front View  
(front door removed)**

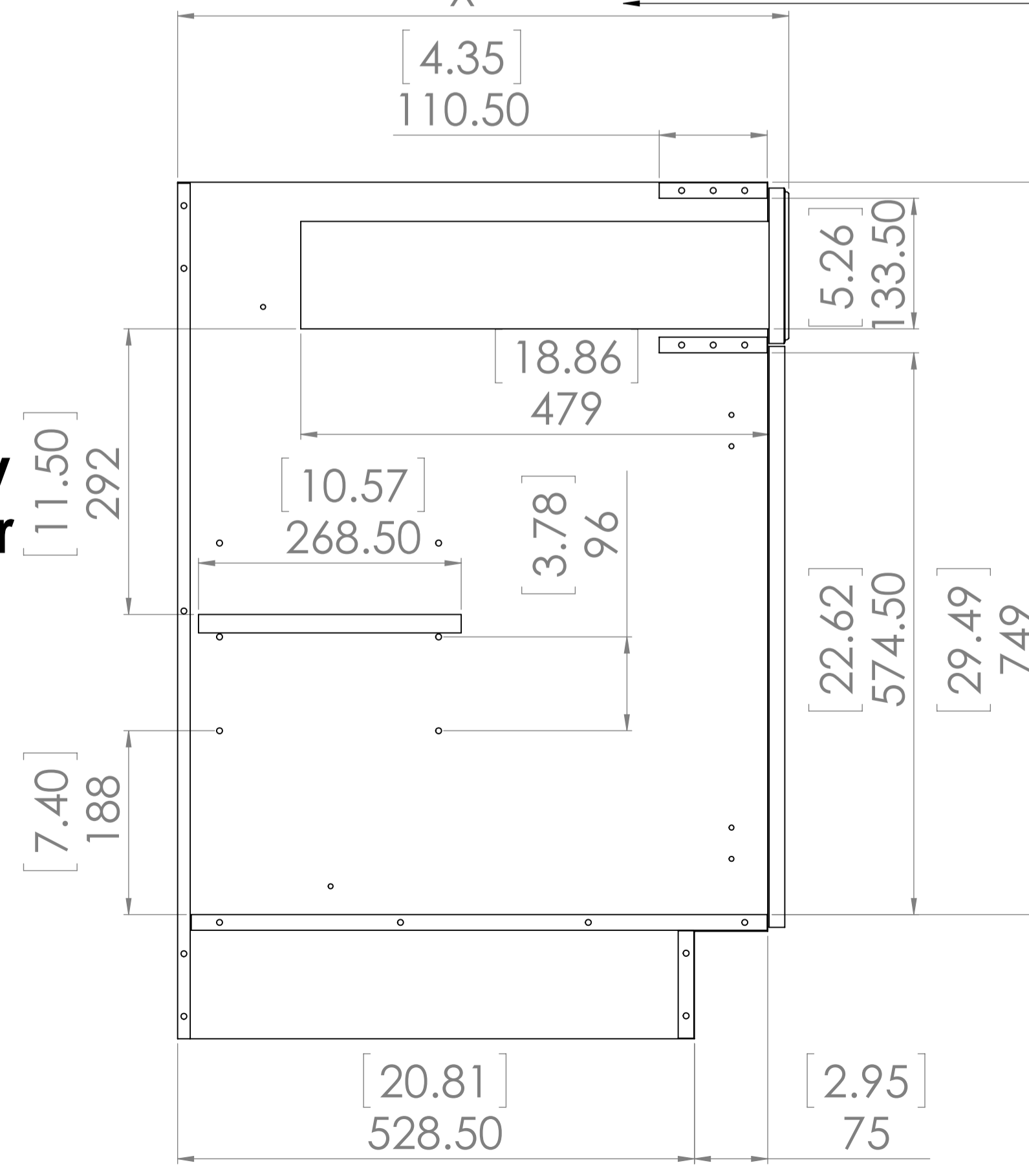

Depth "X" depends on door profile

**Side View  
(left panel removed)**

	NAME	SIGNATURE	DATE	MATERIAL:	
DRAWN	R. Rubio		11/09/17	Plywood CM-WH.	
CHK'D	R. Rubio		11/09/17	Particle Board the	
APPV'D	R. Rubio		11/09/17	other Cabinets.	
MFG	R. Rubio		11/09/17		
PROPRIETARY AND CONFIDENTIAL THE INFORMATION CONTAINED IN THIS DRAWING IS THE SOLE PROPERTY OF WOODCRAFTERS. ANY REPRODUCTION IN PART OR AS A WHOLE WITHOUT THE WRITTEN PERMISSION OF WOODCRAFTERS IS PROHIBITED.				UNLESS OTHERWISE SPECIFIED DIMENSIONS ARE IN mm. AND (INCHES) TOLERANCES ARE +/- 1[0.039]	<b>Base Cabinet_30in</b> SCALE:1:10 SHEET 1 OF 1