



Assembly and Owner's Manual

3425CLA/3495CLA EASY ACCESS Two Drawer* VERTICAL CHARCOAL SMOKER



* Patent Pending

ASSEMBLER / INSTALLER:

Leave these instructions with the consumer.

CONSUMER / USER:

This instruction manual contains important information necessary for the proper assembly and safe use of this appliance. Read and follow all warnings and instructions before assembling and using this appliance. Follow all warnings and instructions when using this appliance. Keep this manual for future reference.

DANGER:

1. Never operate this appliance unattended.
2. Never operate this appliance within 25 feet (7.5m) of any flammable liquid.

Failure to follow these instruction could result in fire, explosion or burn hazard, which could cause property damage, personal injury or death.

STATEMENT OF COMMITMENT

Congratulations and thank you for your purchase of our Great Outdoors Smoky Mountain Smoker. We are pleased that you have recognized the value of the design, function and quality of components used in the product.

We are committed to producing quality products that your family will enjoy for years to come. If for any reason we have failed to meet or exceed your expectations, please allow us the opportunity to make it right by calling us toll free at:

1-800-321-3473

between the hours 8:00am and 5:00pm, EST, Monday through Friday

We want you to be completely satisfied with your purchase.

For your future records, please fill in:

Model # _____

Serial # _____

Date of Purchase: _____

Place of Purchase: _____

 **LANDMANN**

Landmann USA, Inc.
7405 Graham Rd.
Fairburn, Georgia 30213

Service Note:

If you are experiencing difficulties or are dissatisfied with your purchase, please contact Landmann at the telephone number listed above prior to returning your product to the store.





















For more information about growing family of Smokers, Grills, Fire Pits, Firewood Storage and Fireplace Accessories, please visit our website:

[www. landmann-usa.com](http://www.landmann-usa.com)







READ ALL INSTRUCTIONS AND WARNINGS!

YOUR SAFETY IS VERY IMPORTANT - FAILURE TO FOLLOW PROPER PROCEDURES AND SAFEGUARDS MAY RESULT IN PERSONAL INJURY OR PROPERTY DAMAGE.

WARNING

-  **DO NOT use this smoker in a manner other than its intended purpose. It is not intended for commercial use. It is NOT intended to be installed or used in or on a recreational vehicle and/or boats. The smoker is not to be used as a heater.**
-  **Keep a fire extinguisher accessible at all times.**
-  **The use of alcohol, prescription or non-prescription drugs may impair the user's ability to properly assemble or safely operate the smoker.**
-  **This smoker is for outdoor use only, in a well-ventilated area. DO NOT operate the smoker indoors, in a garage, or in any other enclosed area or under overhead construction.**
-  **Use caution when assembling and operating the smoker to avoid cuts and scrapes from rough or sharp edges.**
-  **Use caution when lifting and moving the smoker to avoid strains or back injury. Two (2) people are recommended to lift or move the smoker. DO NOT move the smoker while it is in use.**
-  **DO NOT operate the smoker near or under flammable or combustible materials such as decks, porches or carports. The minimum clearance shall be at least 24 inches (6.1cm) from any structure or combustible material. DO NOT operate the smoker under overhead construction.**
-  **Operate the smoker only on stable, level, non-flammable surfaces such as asphalt, concrete or solid ground. DO NOT operate the smoker on flammable material such as carpet or a wood deck.**
-  **DO NOT store the smoker near gasoline or other combustible liquids or where combustible vapors may be present.**
-  **DO NOT store or operate the smoker in an area accessible to children or pets. Store the smoker in a dry, protected location.**
-  **DO NOT leave the smoker unattended while it is in use. Operate the smoker with close supervision.**
-  **DO NOT allow anyone to conduct activities around the smoker during or following its use until it has cooled. It is hot during operation and remains hot for a period of time following use.**
-  **DO NOT leave hot ashes unattended until the smoker cools completely.**
-  **DO NOT move the smoker while it is in use. Allow the smoker to cool completely before moving or storing.**
-  **This smoker becomes extremely hot - allow the smoker to cool completely before handling. If you must handle the smoker while it is hot, ALWAYS wear protective oven mitts or heat-resistant gloves when handling the smoker or its components.**
-  **Never use gasoline or other highly volatile fluids as a starter. They can EXPLODE!**
-  **The water pan and wood chip box should not be removed while the smoker is operating or until the smoker has cooled sufficiently. These contain hot liquid and hot ashes that may cause serious injury. If you must move these components, ALWAYS wear protective oven mitts or heat-resistant gloves.**
-  **Dispose of cold ashes by wrapping them in heavy aluminum foil and putting them in a non-combustible container. Be sure there are no other combustible materials in or near the container.**
-  **If you must dispose of the ashes in less time than it takes for them to completely cool, remove the ashes from the smoker, keeping them in heavy duty foil and soaking them completely with water before disposing of them in a non-combustible container.**
-  **DO NOT obstruct the flow of combustion air and/or ventilation air for the smoker.**

WARNING

-  Use caution when operating the door while in operation. Keep hands, face and body safe from hot steam or flare ups.
-  **DO NOT** wear loose clothing while operating the smoker. Tie back long hair while operating the smoker. **ALWAYS** wear fully-covering shoes while operating the smoker.
-  Allow the smoker and its components to cool completely before conducting any routine cleaning or maintenance.
-  **NEVER** use glassware, plastic or ceramic cookware on or in your smoker.
-  **NEVER** operate the smoker without water in the water pan. **NEVER** allow the water to completely evaporate. Check the water level at least every 2 hours. A sizzling sound may indicate a low water level or bellowing smoke may indicate no water in the water pan. Follow instructions in this manual for adding water while operating. Adding while operating may splash hot water and cause serious injury.
-  When using flavoring wood, add a sufficient amount prior to operation to avoid having to add wood while operating. Adding while operating may splash hot water and cause serious injury.
-  Use of accessories not intended for this smoker is not recommended and may lead to injury or property damage.

**USE CAUTION AND COMMON SENSE WHEN OPERATING YOUR SMOKER.
READ ALL INSTRUCTIONS, WARNINGS AND SAFEGUARDS BEFORE ASSEMBLING
AND OPERATION YOUR SMOKER.**

SAVE THESE INSTRUCTIONS!

Assembly Step 1 - Identifying the parts

Check your contents for these parts. If you are missing any parts or if any parts are damaged, please call our toll-free customer service line to order parts:

1-800-321-3473

DO NOT RETURN YOUR SMOKER TO THE RETAILER. PLEASE CALL US FIRST.

3425CLA Vertical Charcoal Smoker



AZ002130
Temperature
Gauge

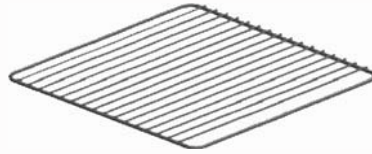

AZ002031 Cooking Rack



AZ002001 Meat hanger



AZ002075
Adjustable
Chimney

AZ002106
CABINET & DOOR



AZ002108 Door Panel



AZ002071
Nylon
Plastic
Door
handle



AZ002122 Side Handle



AZ002129 Damper Vent
with Plastic Tip Guard



AZ002024
Water Pan

AZ002064
Water Pan
Drawer

AZ002076
Nylon Plastic
drawer handle
with logo



AZ002128-COA
Charcoal Pan
Drawer

AZ002071
Nylon Plastic
drawer handle



AZ002068 Ash Holder

AZ001106
Steel Tube Leg



AZ002067 Charcoal Grate



AZ002066 Charcoal Pan

Assembly Step 1 - Continued

Check your contents for these parts. If you are missing any parts or if any parts are damaged, please call our toll-free customer service line to order parts:

1-800-321-3473

DO NOT RETURN YOUR SMOKER TO THE RETAILER. PLEASE CALL US FIRST.

3495CLA CHARCOAL VERTICAL SMOKER PARTS

Part Number	Description	Qty
AZ001106	STEEL TUBE LEG	4
AZ002001	MEAT HANGER	1
AZ002024	WATER PAN	1
AZ002031	COOKING RACK	4
AZ002064	WATER PAN DRAWER	1
AZ002066	CHARCOAL PAN	1
AZ002067	CHARCOAL GRATE	1
AZ002068	ASH HOLDER	1
AZ002069	WIRE RACK TRACK	2
AZ002071	DOOR HANDLE - Nylon Plastic - no logo	2
AZ002072	MAGNETIC CONNECTORS	2
AZ002075	CHIMNEY ASSEMBLY	1
AZ002076	DRAWER HANDLES - Nylon Plastic - with logo	1
AZ002106	DOOR PANEL	1
AZ002107	CABINET ASSEMBLY	1
AZ002108	CABINET (no door)	1
AZ002122	SIDE HANDLE - Steel 7"	2
AZ002128-COA	CHARCOAL PAN DRAWER	1
AZ002129	DAMPER PLATE with plastic tip guards	2
AZ002130	TEMPERATURE GAUGE with wingnuts	1
AZ002132	HARDWARE KIT - 2 drawer Smokers	1
IM3425CLA	INSTRUCTION MANUAL	1
31971	COVER (not included - available as a purchased accessory via our website: www.landmann-usa.com)	n/a

Assembly Step 2

Locate these parts:

Vent Damper Plate
with plastic tab guard



Tools needed:



Phillips Head
Screwdriver



8mm Wrench

Hardware:



M5 nut
2 required



5.5mm lock washer
2 required



M5 x 15 bolt
2 required

Hardware Bag 

1. Remove all loose inner packages from inside cabinet. Set the cabinet assembly top side down. To prevent scratching or damage to your smoker, set the cabinet on a padded surface like cardboard or carpet.
2. Set the damper plate on the side of the cabinet and align it with the corresponding "butterfly" holes. The metal tab should seat inside the one of these holes and the plastic tab guard should be positioned towards the top of the smoker.
3. Insert a bolt through the damper plate center hole and through corresponding hole in the center of the "butterfly" hole.
4. From the inside of the cooking chamber, place a lock washer and nut on the bolt and secure.
5. Thread nut just tight enough to keep the damper plate snug but allow it to rotate with little resistance.
6. Repeat on other side of cooking chamber.

Note that the metal tab that goes inside the "butterfly" holes is specifically designed to keep these vent partially open at all times.

This is a safety feature required in all Smoky Mountain Vertical Smokers.

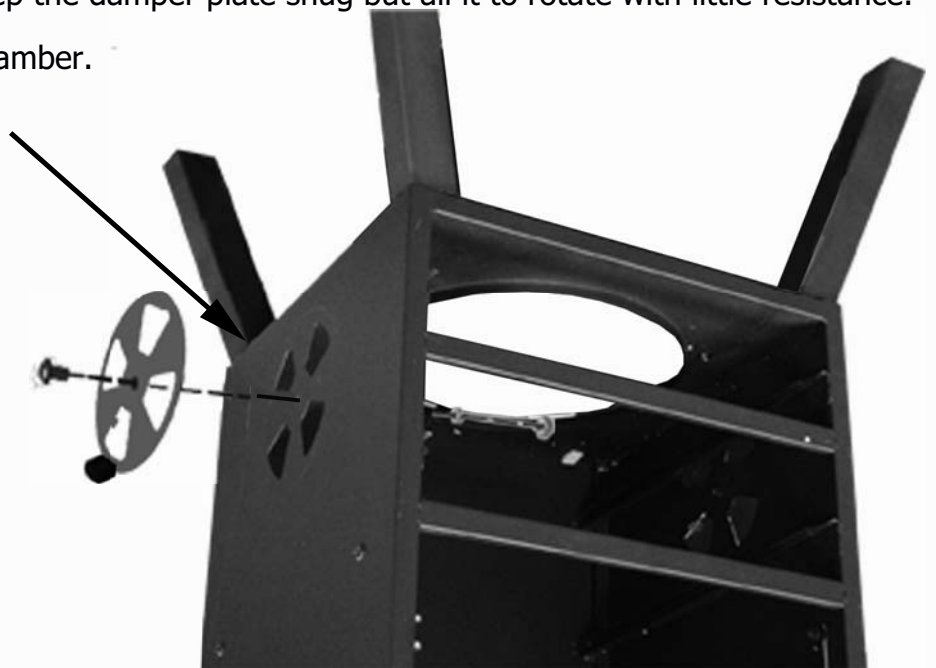

Assembly Step 3

Locate these parts:

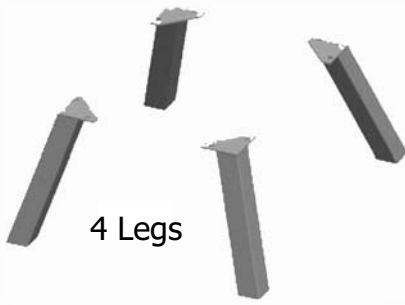

Cabinet Assembly



Tools needed:



Phillips Head Screwdriver

Hardware:



M6 x 15 bolts
8 required

Hardware Bag **A**

1. For each leg, line up the holes and insert the bolts. Nuts are pre-welded to the cabinet. The back legs bolts should be inserted and securely tightened. Then the front legs bolts should be inserted and securely tightened.

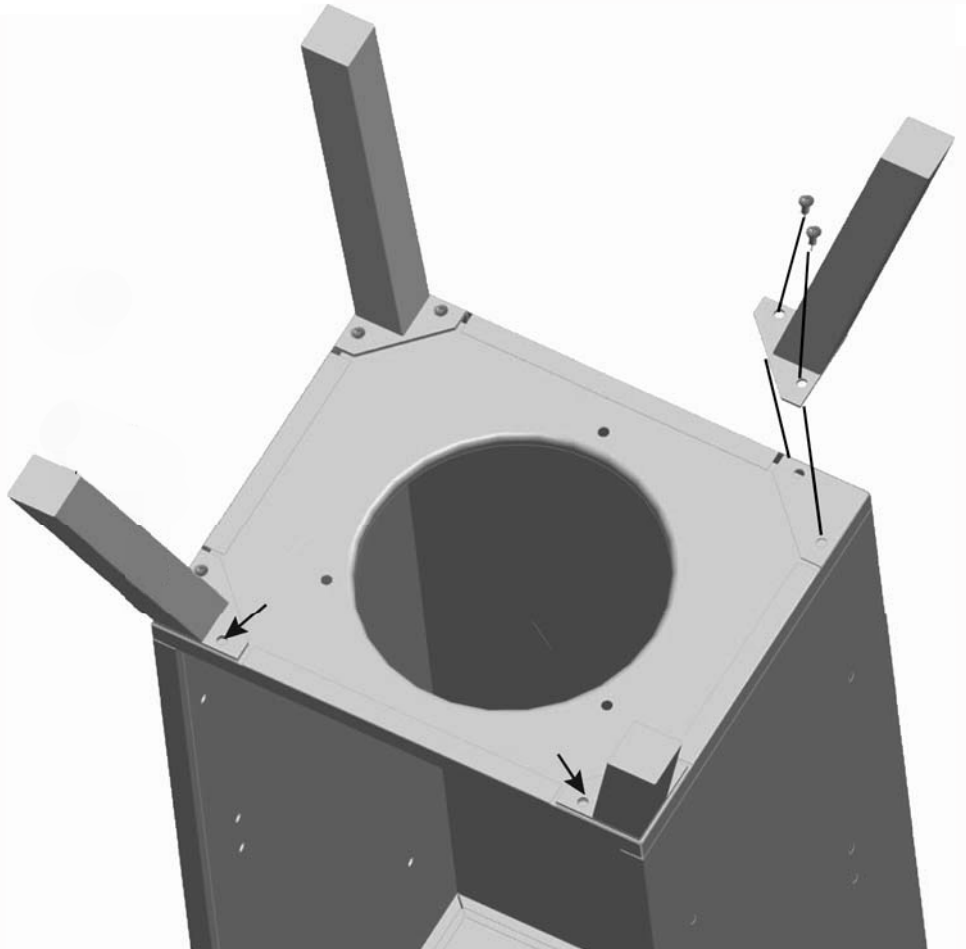

Assembly Step 4

Locate these parts:

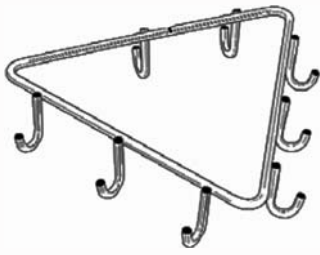

Meat Hanger



Adjustable Chimney

Tools needed:



Phillips Head
Screwdriver

Hardware:



M5 x 8 bolt
1 required



M6 x 10 bolts
3 required

Hardware Bag **(B)**

1. Turn the smoker upright. Ideally, it needs 2 people to lift the smoker up. Carefully tilt the cabinet on the side legs, grasp the empty hole for the adjustable chimney and pull up gently until smoker is upright on all four legs.
2. Set the Adjustable Chimney on top of the cabinet and align the 3 thread tabs from the underneath with the corresponding holes. The nuts for the bolts are pre-welded to the bottom of the chimney base. Position Adjustable Chimney knob so the adjustment now is on the right side.
3. Reaching inside the cooking chamber, thread a bolt through the corresponding opening and into the pre-welded nuts. Thread each bolt 1/2 way until all 3 bolts are threaded and then tighten each bolt securely.
4. To attach the Meat Hanger, position the Meat Hanger into the metal tabs on the underneath part of the top of the cooking chamber. Make sure that the bolt end of the Meat Hanger matches up with the attached thread tab. Insert bolt and tighten.

Meat Hanger

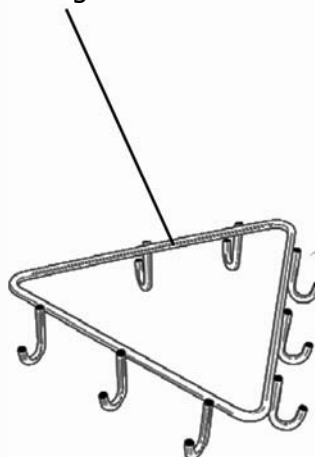

Adjustable
Chimney

Cabinet top

Assembly Step 5

Locate these parts:

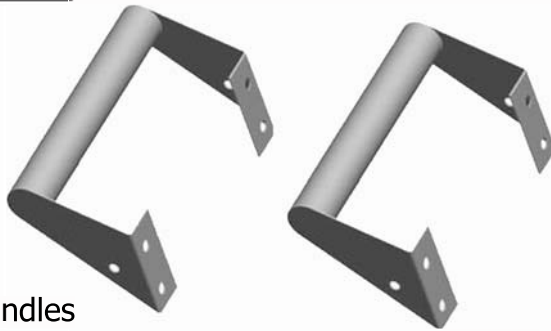

2 Side Carry handles

Tools needed:



Phillips Head
Screwdriver



10mm Wrench

Hardware:



M6 Nuts
8 Required



6.5mm Lock Washers
8 Required



M6 x 15 Bolt
8 Required

Hardware Bag **D**

1. Align the side carry handle with the corresponding holes on the side of the cabinet. Then handles must be positioned upright with the bolt holes on the bottom.
2. Insert the bolts from the outside and the thread the lock washers and nuts from the inside of the cabinet.
3. Securely tighten the nuts using both screwdriver and wrench.
4. Complete steps for both sides of the cabinet assembly.

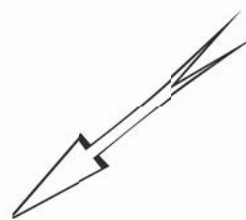

Assembly Step 6

Locate these parts:



Water pan drawer
with Nylon Plastic handle
with Logo



Charcoal Pan drawer
with Nylon Plastic handle

Tools needed:



Phillips Head
Screwdriver



10mm Wrench

Hardware:



M6 nut
4 required



6.5mm lock washer
4 required



M6 x 15 bolt
4 required

Hardware Bag **D**

1. Align the drawer handle bracket holes to match the holes in the front panel of the drawers.
2. Insert the bolts from the outside and the thread to the lock washers and nuts from the inside of the drawers.
3. Securely tighten the nuts using both screwdriver and wrench.
4. Complete steps for both drawers.

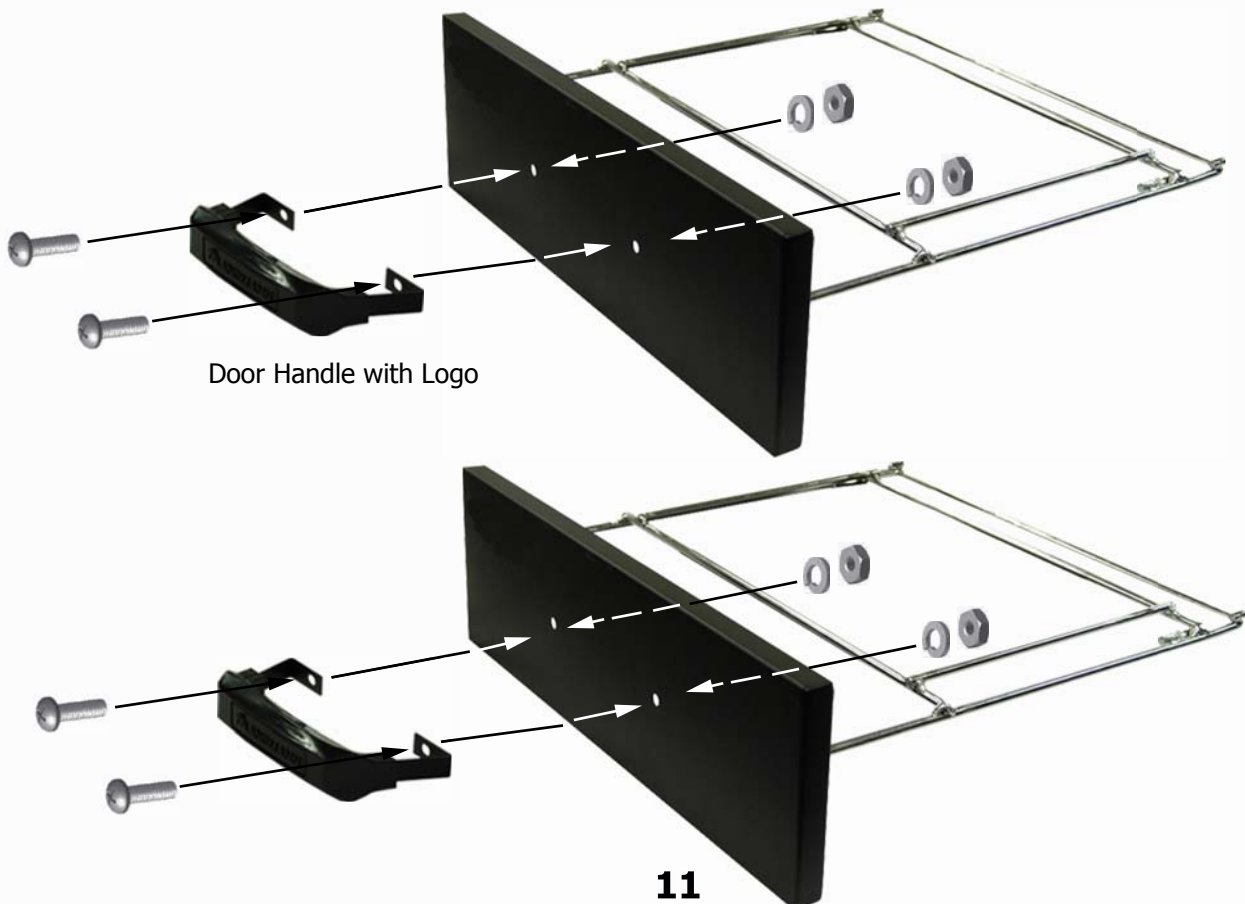

Assembly Step 7

Locate these parts:



Water Pan Drawer



Charcoal Pan Drawer

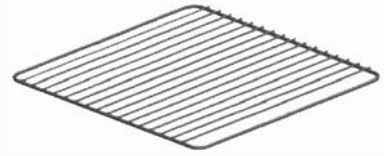

Cooking racks

NOTE: No tools or hardware are required for this step.

1. Insert cooking grids into available rack positions and grease pan as shown.
2. Place charcoal grate in charcoal pan and position complete on drawer frame as shown. Slide charcoal pan drawer into cabinet.
3. Position water pan on drawer frame as shown, and then slide water pan drawer into cabinet.

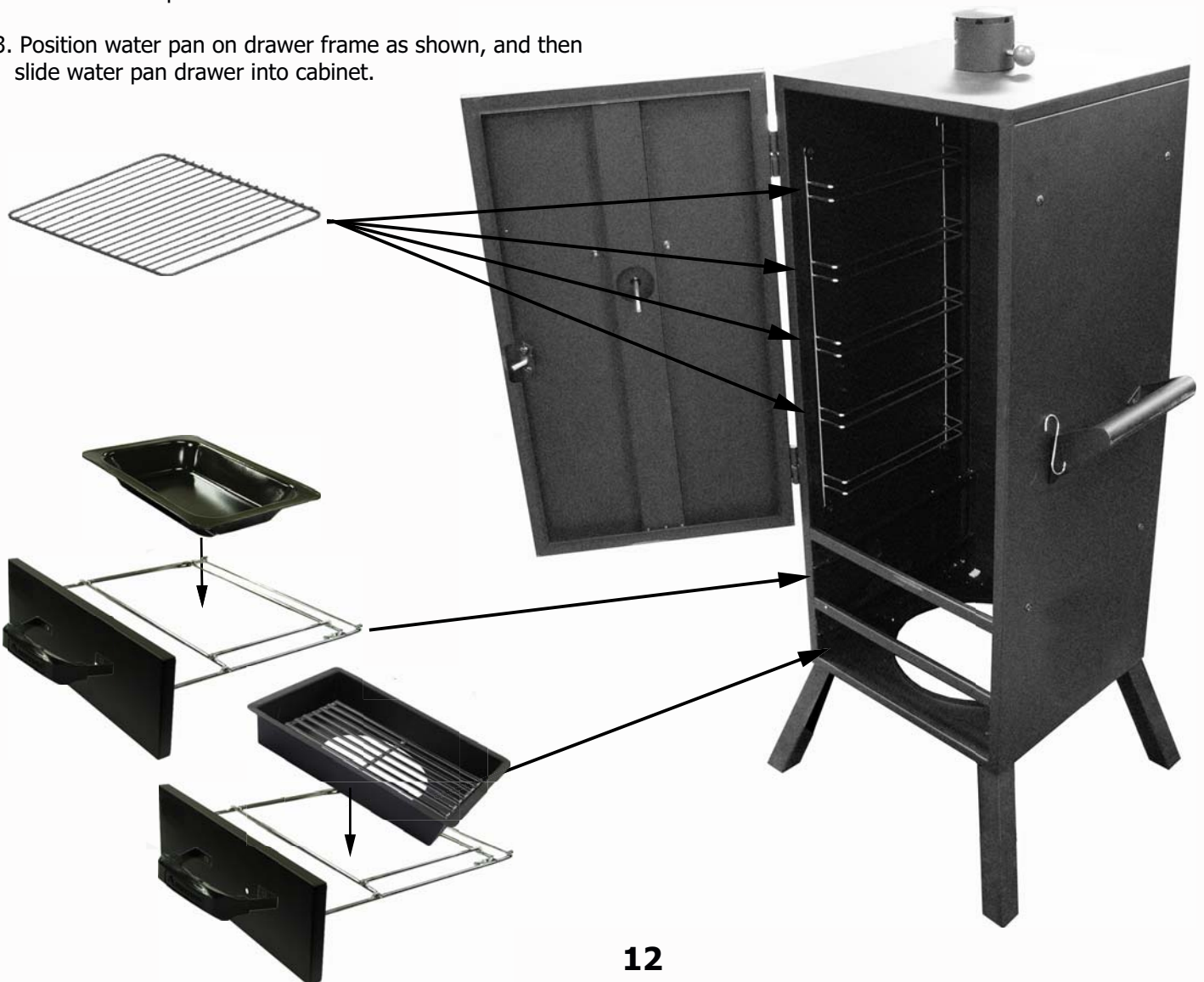

Assembly Step 8

Locate these parts:



Nylon Plastic Door handle

Tools needed:



Phillips Head
Screwdriver



10mm Wrench

Hardware:



M6 nut
2 required



6.5mm lock washer
2 required



M6 x 15 bolt
2 required

Hardware Bag **D**

1. Align the door handle with the corresponding holes on the front of the cabinet door.
2. Insert the bolt through hole in door handle bracket and then thread the lock washers and nuts from the inside of the door..
3. Securely tighten the nuts using both screwdriver and wrench.

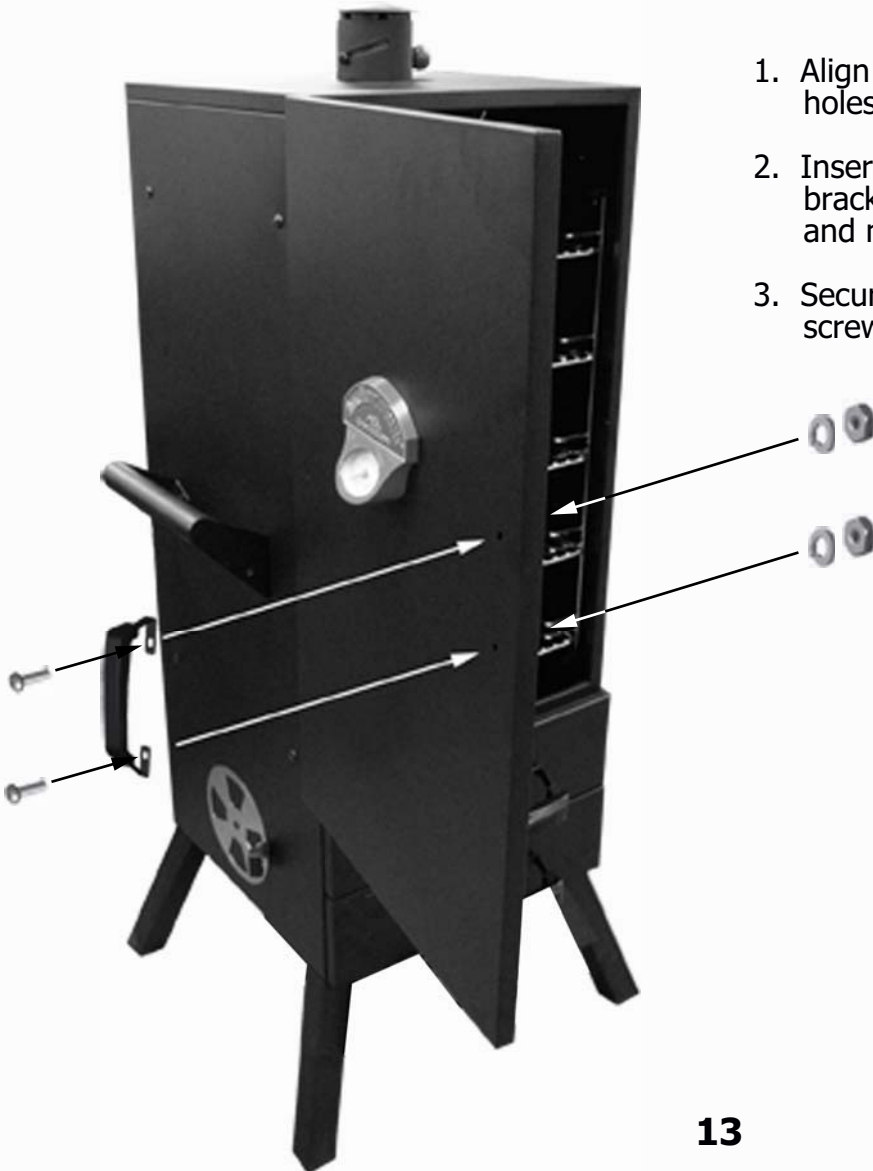

Assembly Step 9

Locate these parts:

Name-plate
Temperature Gauge

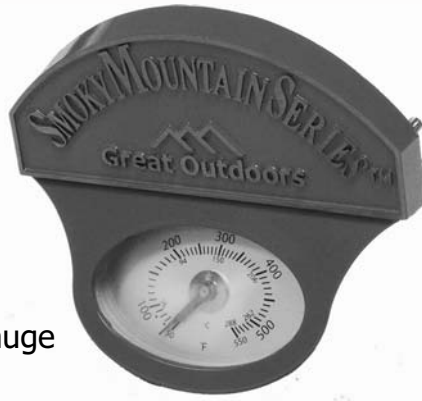

2 wingnuts



2 flat washers

Hardware Box **I**

NOTE: No tools or hardware are required for this step.

1. Insert the Temperature Gauge mounting pins through the mounting holes in the front of the door panel.
2. From the inside of the door, securely attach flat washer and wingnut to each mounting pin.

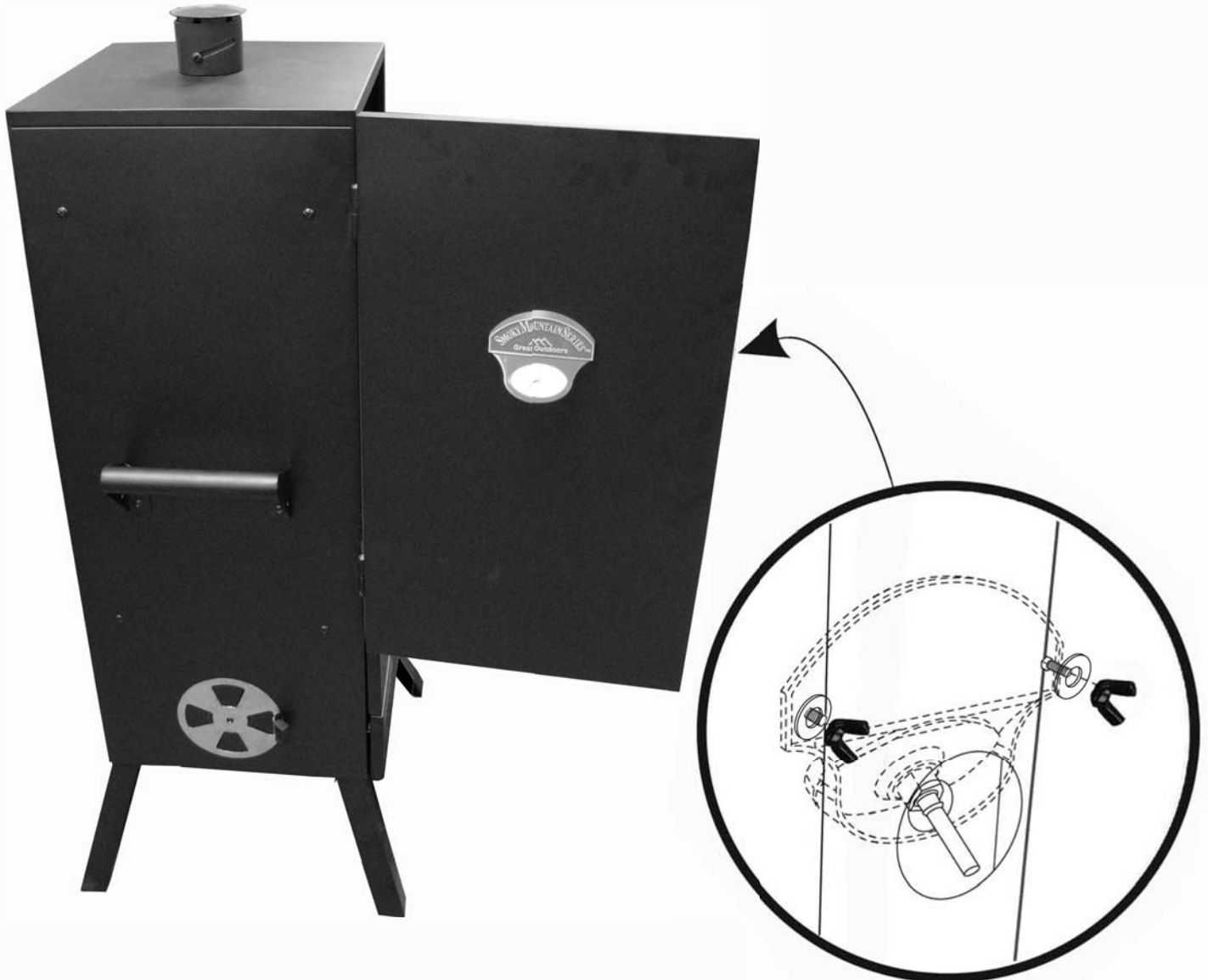

Assembly Step 10

Locate these parts:



Ash Holder

No tools or hardware are required for this step.

Slide the ash holder into the bottom rack position as shown.
Make sure it is seated properly.



15

LIGHTING PROCEDURES:

Before you light your smoker, it is recommended that you choose our igniting substances carefully. **Use only lighting fluid specifically designed for outdoor charcoal or wood lighting.**

For best flavor, we recommend using **NON-TOXIC** lighting fluids. Or, for even better results and ease of lighting, you can use a wax lighting block or electric charcoal starter.

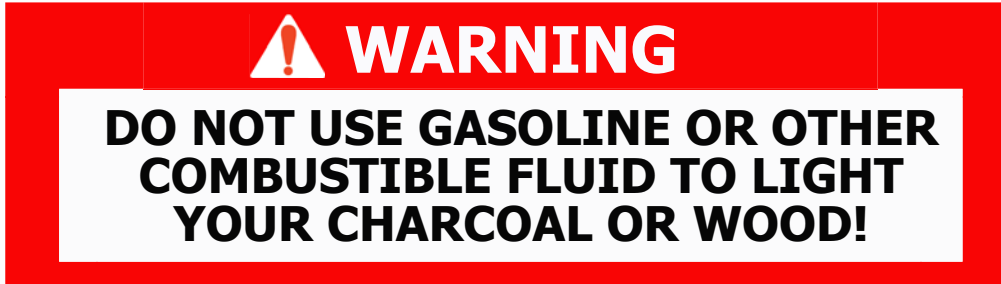

- * Place a sufficient amount of charcoal and/or hardwood in the charcoal pan.
- * You may choose a number of methods of lighting your charcoal or wood.
- * Place the charcoal pan in the bottom of the smoker with the handle facing to the front of the smoker.
- * Light the charcoal or wood using a long-reaching match or lighter.
- * Leave the smoker door open until the charcoal or wood is fully lit and then close the door to allow heat to accumulate. The damper vents can then be adjusted to the desired setting to allow proper air flow and combustion.
- * If using an electric charcoal starter, make sure to remove the starter from the smoker once the charcoal is lit and prior to operating the smoker.

CHIMNEY AND DAMPER VENT ADJUSTMENTS:

Temperature maintenance is best controlled by different chimney and side damper adjustments. The key to effective smoking is to watch your heat indicator (temperature gauge) on the door and adjust the chimney and side dampers accordingly.

- * For better performance, rotate the smoker to where the front or back of the smoker is facing the wind. This allows the adjustment of the chimney and side damper vents to be more effective and accurate.
- * Opening the chimney and side damper vents helps to exhaust both heat and smoke.
- * The chimney and side dampers vents **SHOULD NEVER BE FULLY CLOSED.**
- * Opening the side damper vents allows more oxygen to be consumed by the fire, fueling flames and causing an increase in temperature.
- * Temperature maintenance is best controlled by different chimney and side damper adjustment configurations.

OPERATING INSTRUCTIONS

PRE-USE PROCEDURES:

Before you cook food in our smoker, it is important to "season" your smoker. Seasoning seals the paint and interior of your smoker to enhance flavoring, durability and overall performance. This is also referred to as the "break-in" process.

If your smoker requires any touch-up paint on the inside of the cabinet, the only time you should apply paint to the inside is before the seasoning process. Paint should never be applied to the interior of your smoker after your smoker has been used. See these section in this instruction manual concerning AFTER USE CARE AND MAINTENANCE.

To season your smoker, simply use it as you normally would, only DO NOT cook any food. You will need to follow all of the operating procedures in the next few sections of this manual.

Using your desired flavoring woods and placing water in the water pan, burn your smoker at around 225 degrees and allow 45-60 minutes for this burn. Allow the smoker to completely cool and then clean out the used water and wood.

Once the seasoning is complete, your smoker's interior will have a durable, seasoning coating.

ADDING WATER:

To add water before cooking:

For one door smokers, simply remove water pan and fill it with water up to 1" (25mm) below the rim. Then carefully place the water pan in the correct shelf position in the cabinet. To add water while the smoker is hot, DO NOT PULL THE WATER PAN OUT! To safely add water to the water pan, use a clean watering can with a long spout (or similar device).



For Two Drawer smokers, open water pan drawer and fill with water up to 1" (25mm) below the rim. Slowly and steadily, push water pan drawer closed until it comes to a complete stop. To add water while the smoker is hot, SLOWLY open the water pan drawer to prevent any splashing of remaining water. Replenish the water as need and then again SLOWLY and CAREFULLY push the water pan drawer closed until it comes to a complete stop.



ADDING WOOD CHIPS

To add wood chips or chunks for smoking, carefully open the charcoal pan drawer and add pre-soaked (for best results pre-soak in water for at least 30 minutes) wood chips or chunks to the sides of the charcoal pan. The amount and type of wood you use is entirely up to you.



COOKING TIPS - Flavored woods:

- * Use dry hardwoods such as hickory, pecan, apple, cherry or mesquite.
- * Most fruit and nut tree woods produce an excellent smoke flavoring.
- * Do not use resinous woods such as pine. These usually product unpleasant flavoring.
- * Let our taste be your guide - experiment with different types and quantities of wood chunks, chips or sticks. You also mix woods.
- * To produce more smoke and prevent fast burning, pre-soak the wood chips in a separate bowl of water for at least 30 minute, or wrap the chips in perforated aluminum foil.
[See wood chip manufacturer's instructions]
- * Most smoker flavoring occurs within the first hour of cooking. Adding wood chips after the first hour is typecially not necessary unless extra smoke flavoring is desired.



CAUTION

THE CHARCOAL PAN WILL GET VERY HOT DURING SMOKING. AVOID HANDLING THIS WHILE IN USE. ALWAYS WEAR PROTECTIVE OVEN MITTS WHEN HANDLING HOT COMPONENTS.

COOKING INSTRUCTIONS:

- * Carefully add wood chips or chunks inside the smoker as instructed in the assembly section of this instruction manual. Refer to the section that explains adding wood chips for recommended use.
- * Place the water pan inside the smoker as instructed in the assembly section of this instruction manual. Carefully fill the water pan with water (or marinade) up to 1" (25mm) below the water pan rim. DO NOT over fill or allow water to overflow from the water pan. A full water pan should last for approximately 2-3 hours. Checking and adding water to the water pan is covered on page 21.
- * Insert or adjust the cooking racks to the desired rack positions. For better access to the food with tongs or spatulas, (1) use only the cooking racks needed for your smoking and (2) be sure the grids of the cooking racks run front-to-back as shown in the assembly section.
- * You are now ready to light your smoker. Refer to the Lighting procedure on the previous pages of this manual and carefully follow the directions. Adjust the Chimney and side dampers to control the heat.
- * Place the food on the cooking racks in a single layer with space between each piece. This will allow smoke and hot moisture to circulate evenly around the food pieces.
- * Depending on meat and size, smoking for 2 to 3 hours at the ideal constant cooking temperature of 225°F to 250°F will get the best results. The temperature is according to the heat indication (temperature gauge) mounted on the front of the door. For more tender and heavily smoked meat, a lower temperature of 220-225°F and smoking for 4 to 6 hours, may be preferred. If time is critical, a higher temperature range is recommended.
- * Always use a meat probe thermometer to ensure the food is fully cooked before removing it from the smoker.
- * Check the water periodically and add water if low. For best results and to retain heat, avoid opening the door or drawer of the smoker while in use. When the door or drawer must be opened, only open it briefly. The smoker will quickly resume cooking temperature after the door or drawer are closed.
- * After each use, and after the smoker has cooled, carefully remove the water pan from the smoker, empty the water and clean the water pan. Same procedure for the Charcoal Pan.

CAUTION: The smoker can be very hot while in use. DO NOT touch any portion of the smoker except for the door or drawer handles. It may be necessary to use protective gloves.

- * Follow all warnings and safety precautions before removing meat from smoker or preparing the smoker for storage. See instructions on proper storage procedures. See all warnings and safeguards on Pages 3 and 4.

TEMPERATURE CHART

Here is a chart for measuring properly cooked meat temperature:

(USDA Standard)

CAUTION

The below temperatures are measured with a meat probe thermometer. The heat indicator on the door of the smoker **SHOULD NOT** be used as an accurate meat temperature reading.

Ground Meats & Meat Mixtures:

Turkey	165°F (74°C)
Veal, Lamb	160°F (71°C)
Beef, Pork	160°F (71°C)

Fresh Beef:

Medium Rare	145°F (63°C)
Medium	160°F (71°C)
Well Done	170°F (77°C)

Fresh Lamb:

Medium Rare	145°F (63°C)
Medium	160°F (71°C)
Well Done	170°F (77°C)

Fresh Beef:

Medium Rare	145°F (63°C)
Medium	160°F (71°C)
Well Done	170°F (77°C)

Fresh Pork:

Medium	160°F (71°C)
Well Done	170°F (77°C)

Ham:

Fresh (raw)	160°F (71°C)
Pre-cooked	140°F (60°C)

Poultry:









Chicken (whole)	180°F (82°C)
Turkey (whole)	180°F (82°C)
Breasts, roast	170°F (77°C)
Thighs, wings	180°F (82°C)
Duck and Goose	180°F (82°C)

Fish:

Cook until opaque and flakes easily

AFTER USE SAFETY

WARNING

-  Use caution when lifting or moving the smoker to avoid strains or back injury. Two (2) people are recommended to lift or move the smoker.
-  DO NOT place cover on smoker if the smoker is still hot.
-  DO NOT store the smoker near gasoline or other combustible liquids or where combustible vapors may be present. Keep the area around the smoker clear of combustible material or vapors.
-  DO NOT store this smoker in an area accessible to children or pets. Store the smoker in a dry, protected location.
-  DO NOT allow anyone to conduct activities around the smoker during use until it has completely cooled. It is hot during operation and remains hot for a period of time following use.
-  DO NOT leave hot ashes unattended until the smokers cools completely.
-  This smoker becomes extremely hot - allow the smoker to cool completely before handling. If you must handle the smoker while it is hot, ALWAYS wear protective oven mitts or heat resistant gloves when handling the smoker or its components. Allow the smoker to cool completely before removing the water pan, wood chip box, cooking racks and/or grease pan for cleaning.
-  Dispose of cold ashes by wrapping them in heavy duty aluminum foil and putting them in a non-combustible container. Be sure there are no other combustible materials in or near the container.
-  If you must dispose of the ashes in less than time than it takes for them to completely cool, remove the ashes from the smoker, keeping them in heavy duty foil, and soak them completely with water before disposing of them in a non-combustible container.

USE CAUTION AND COMMON SENSE WHEN OPERATING YOUR SMOKER. READ ALL INSTRUCTIONS, WARNINGS AND SAFEGUARDS BEFORE ASSEMBLING AND OPERATION YOUR SMOKER.

SAVE THESE INSTRUCTIONS!

AFTER USE CARE AND MAINTENANCE

CAUTION: All care and maintenance procedures are to be performed only while the smoker is turned off and completely cooled.

To clean, remove the water pan, wood chip box and cooking racks from the smoker. Clean with hot, soapy water and rinse and dry thoroughly. You may prefer to coat the water pan cooking racks lightly with cooking oil or cooking spray.

If your heat indicator seems to be out of calibration. There is a flat head screw on the end of the heat indicator that can be turned to adjust the heat indicator needle. Set the needle to the current outdoor ambient temperature and remount the heat indicator to the door of the smoker.

To clean the inside and outside of the smoker cabinet, simply use a damp cloth. Spray washing with a water hose is not recommended. All moisture should be wiped away and not allowed to stand inside or on top of the smoker. Carefully remove the grease pan, dispose of the grease and wash thoroughly. Once cleaned, you may prefer to lightly coat the interior of the smoker cabinet with cooking oil or cooking spray.

If rust is present on the exterior of the smoker, clean it thoroughly with steel wool or emery cloth and use heavy duty, heat resistant paint to cover affected area.

NEVER APPLY additional paint to the interior of the smoker. If rust is present on the interior of the smoker, clean thoroughly with steel wool or emery cloth, and lightly coat the area with cooking oil or cooking spray to minimize recurring rust.

ALWAYS allow the smoker to cool completely before cleaning or checking the assembly.

To protect your smoker from weather, ALWAYS keep your smoker covered when not in use. Cover for your smoker is available for purchase by calling our Customer Service department or visiting our website at www.landman-usa.com

To obtain replacement parts or accessories, call our toll free Customer Service line at **1-800-321-3473**.



Manufacturer's Limited Warranty



The Great Outdoors® Smoky Mountain Series™ smoker is guaranteed against broken or damaged parts at the time of purchase. All parts carry a 1-year limited warranty except the water bowl, which is guaranteed to be free of defects for 90 days. Paint is guaranteed to be free of defects for 90 days except for rust, which may appear after repeated use.

This warranty does not cover damage or issues related to neglect, abuse, or modifications to the product. Repair labor is not covered.

All parts that meet the warranty requirements will be shipped at no-charge via the discretion of the Customer Service Department (ground shipments, US Mail or Parcel Post only). Any special handling charges (i.e. Second Day, Overnight, etc.) will be the responsibility of the consumer.

All warranty claims apply only to the original purchaser and require a proof of purchase verifying the purchase date. Do not return parts to our address without first obtaining a return authorization number for our customer service. This service is available by calling toll free

1-800-321-3473 Monday to Friday 9:00am to 5:00pm Eastern Standard Time.

This warranty may give your specific legal rights that vary by state.

 **LANDMANN**

Landmann USA, Inc.

**7405 Graham Rd.
Fairburn, GA 30213**