



# 10ft 10ft Gazebo





## Assembly and User Manual



NOTE: The schematics in this manual are for assembly and operation illustration only. They may differ from the gazebo's actual appearance.

If you have any questions, problems please **do not return** to the place of purchase. Email our customer service department at **Service@abbspatio.com**

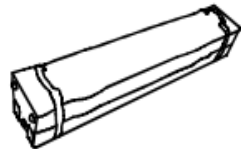
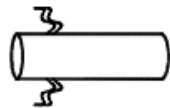
## 2. Package Contents

part	Description	Illustration	Qty
1	FABRIC BODY Gazebo fabric body with 4 guy lines 3M		1
2	FRAME Steel, gazebo frame assembly - without fabric		1
3	CARRY BAG Carry Bag - with wheels-Black		1
4	UNIVERSAL PARTS Stake bag		1
5	STAKES Stake set of eight 7in steel stakes		8

### 3. Package Contents

**Step 1.** Place your frame in the center of area to be shaded. With partners on opposite side, grasp two outer legs, slightly lift off ground and take a step backwards, stopping at full (outerstretched) arm length.

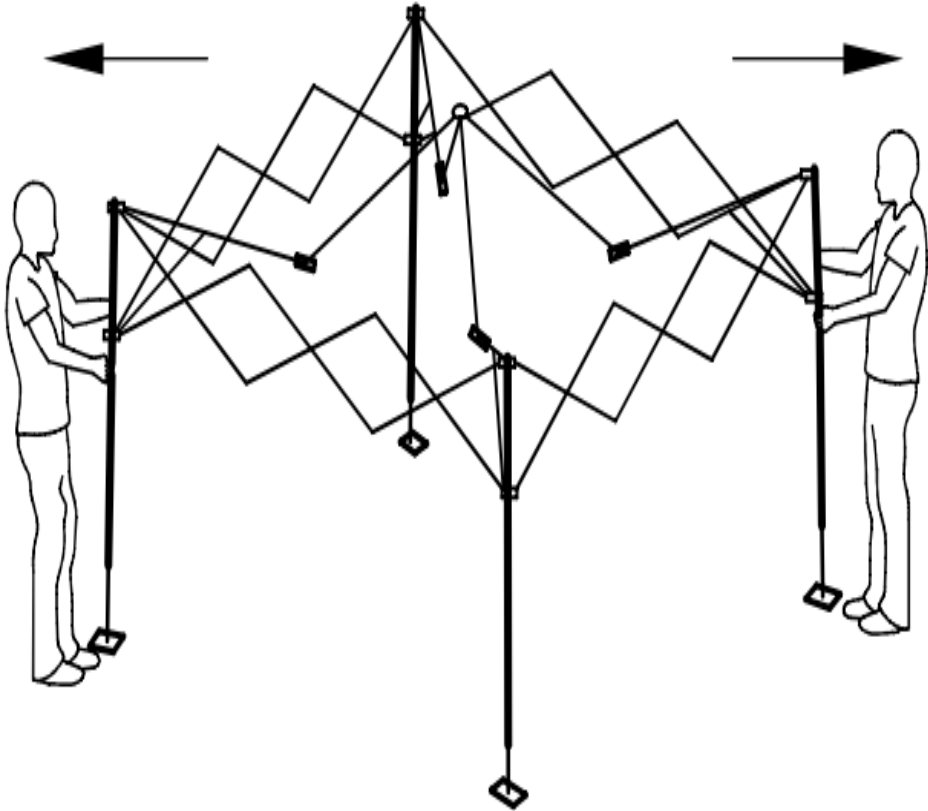

### 4. Assembly Instructions

**Step 2.** Slide frame into locking position

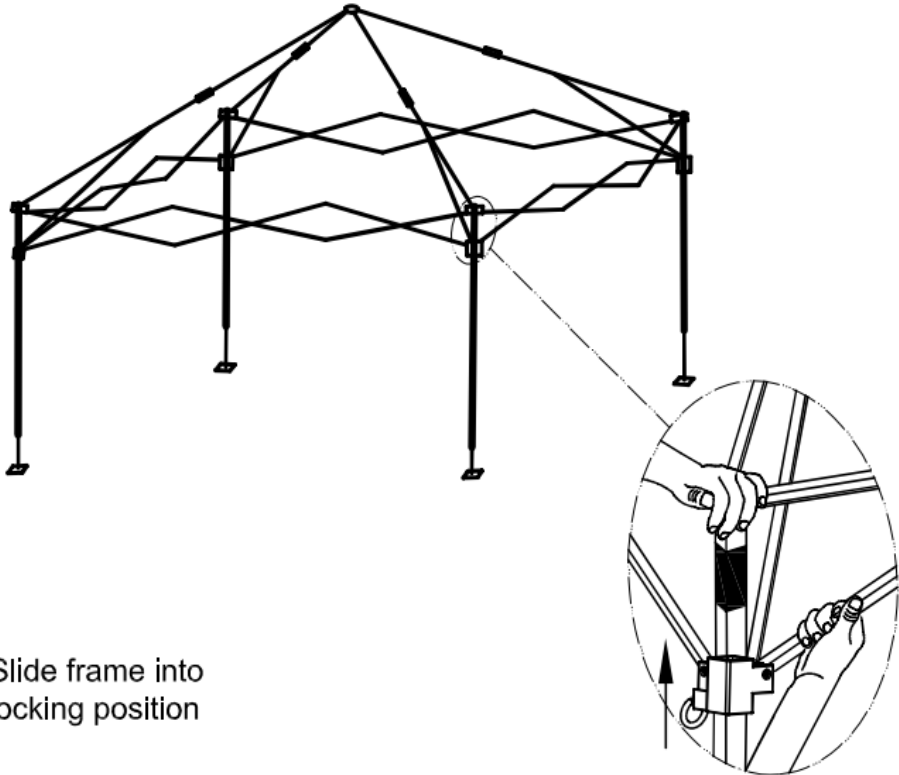

## 5. Assembly Instructions

**Step 3.** Gently unfold the fabric top and place it over the open frame

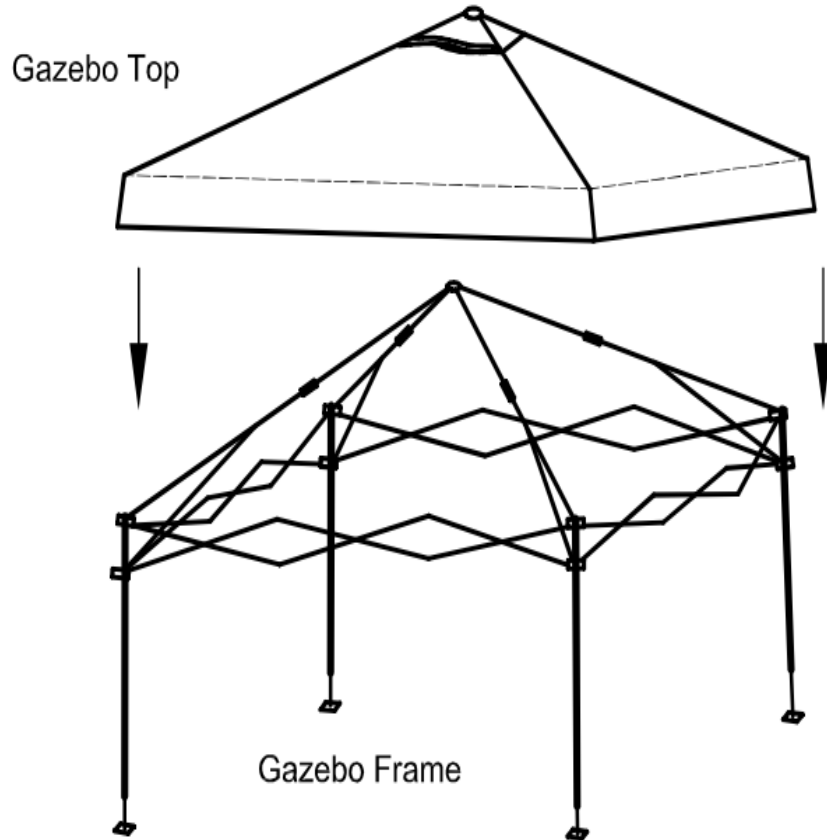

## 6. Assembly Instructions

**Step 4.** Attach the top to the frame,

To secure the fabric top to the frame, please wrap the hook and loop straps around roof tubes and cross beams

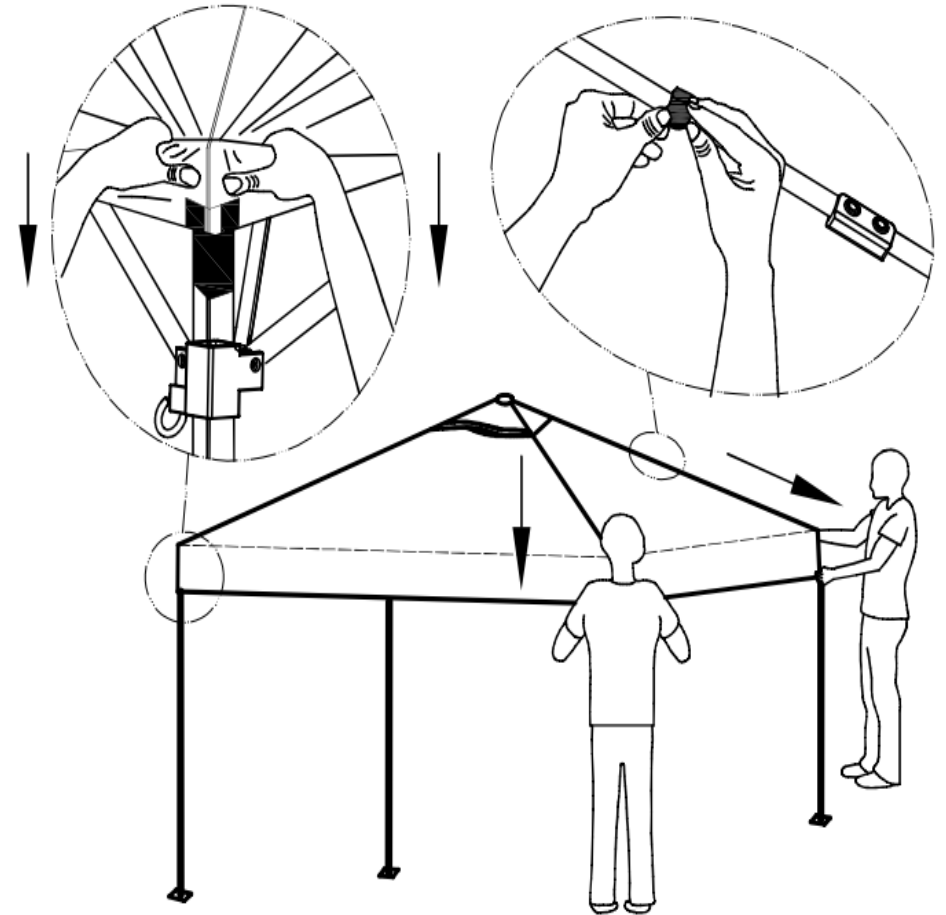

## 7. Assembly Instructions

**Step 5.** Hold push button, move to desired height

**Step 6.** Insert stakes

Use stakes or weight bags to secure in windy conditions.

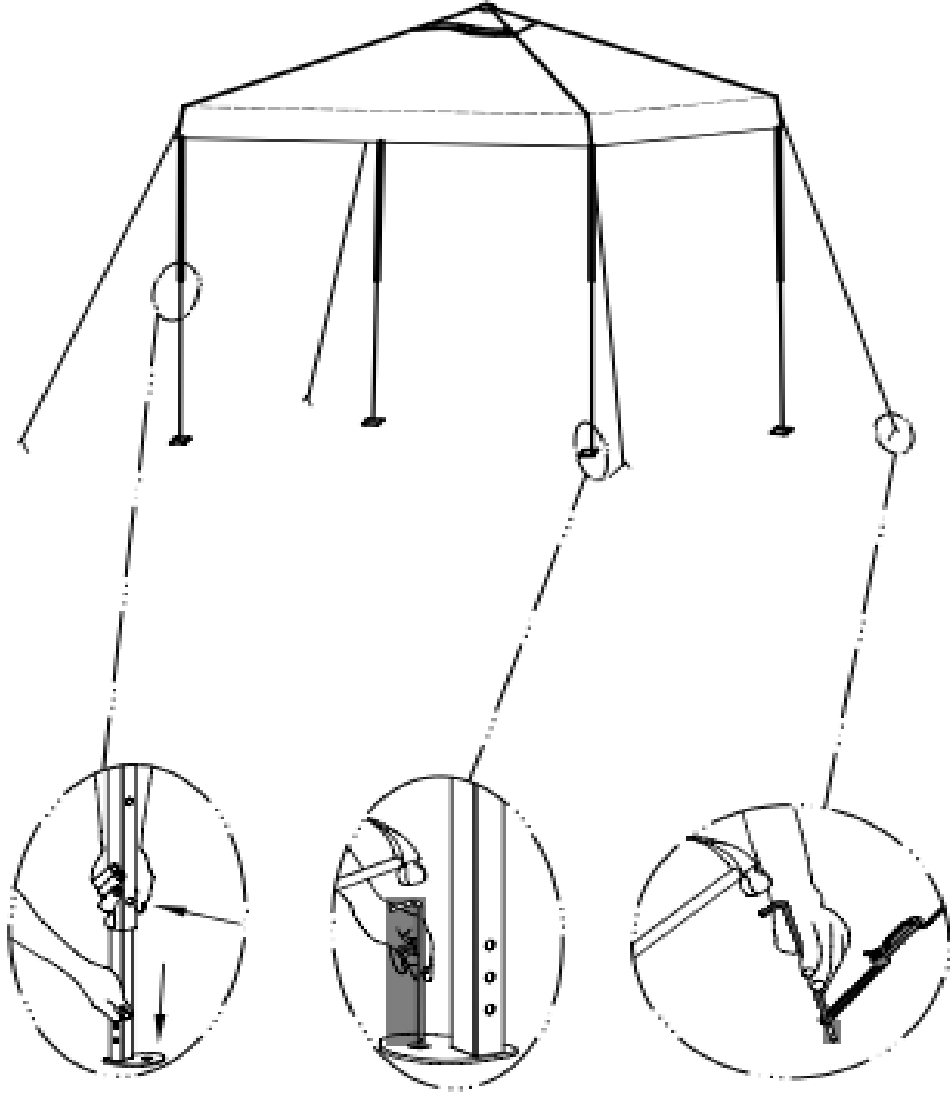

Thanks for choosing Abba Patio products.

We'd love to hear your thoughts, and so would other customers.

If you are satisfied with our products and service, please let us know.

If you have questions or feedback, we're here to help!

[service@abbapatio.com](mailto:service@abbapatio.com) (We will reply you within 24 business hours)