

ASSEMBLY INSTRUCTIONS

BED

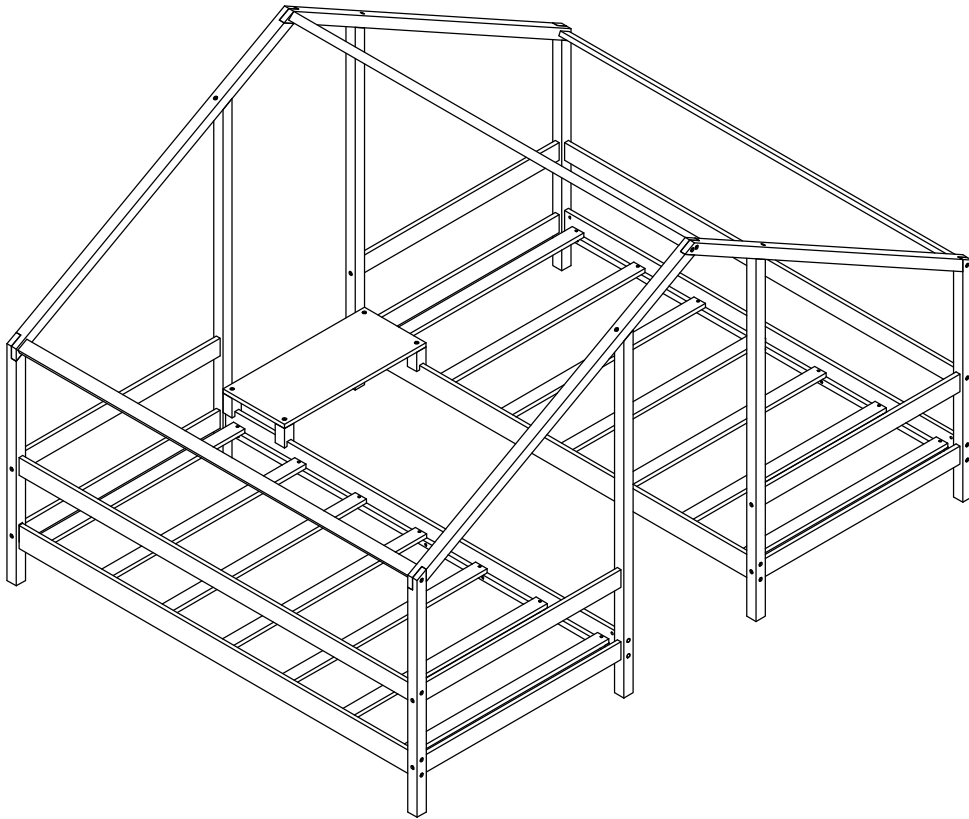

WF286895

★ Replacement Parts:

- Replacement Parts, including additional guardrails, may be obtained from any of our (*GIGACLOUD TECHNOLOGY (USA) INC.*) dealers
- Follow the information on the warnings appearing on the upper bunk bed end structure and on the carton. Do not remove warning label from bed.
- We recommend assembling your loft bed on this shipping carton to protect your floor or carpet.
- Always use the recommended size mattresses or mattress supports, or both, to help prevent the likelihood of entrapment or falls.
- Keep these instructions for future reference.
- This bed is designed to use a twin mattress 38-1/2" wide x 74" to 75" long with the total thickness not exceeding 6" for upper bunk. Do not use mattress without the proper slat system and proper attachments described in the instruction.
- Prohibit more than one person on upper bunk.
- Surface of the mattress must be at least 5". (127 mm) below the upper edge of guardrails.
- Do not allow children under 6 years of age to use the upper bunk.
- Periodically check and ensure that the guardrail, ladder, and other components are in their proper position, free from damage, and that all connectors are tight.
- Do not allow horseplay on or under the bed and prohibit jumping on the bed.
- Always use the ladder for entering and leaving the upper bunk.
- Do not use substitute parts. Contact the manufacturer or dealer for replacement parts.
- Be certain all staples are out of the box before beginning assembly on the shipping carton.
- Use of a night light may provide added safety precaution for a child using the upper bunk.
- Always use guardrails on both long sides of the upper bunk. If the loft bed will be placed next to the wall, the guardrail that runs the full length of the bed should be placed against the wall to prevent entrapment between the bed and the wall.
- The use of water or sleep flotation mattress is prohibited.
- **STRANGULATION HAZARD** - Never attach or hang items to any part of the loft bed that are not designed for use with the bed; for example, but not limited to, hook, belts, and jump ropes. Keep these instructions for future reference.

ASSEMBLY INSTRUCTIONS

BED

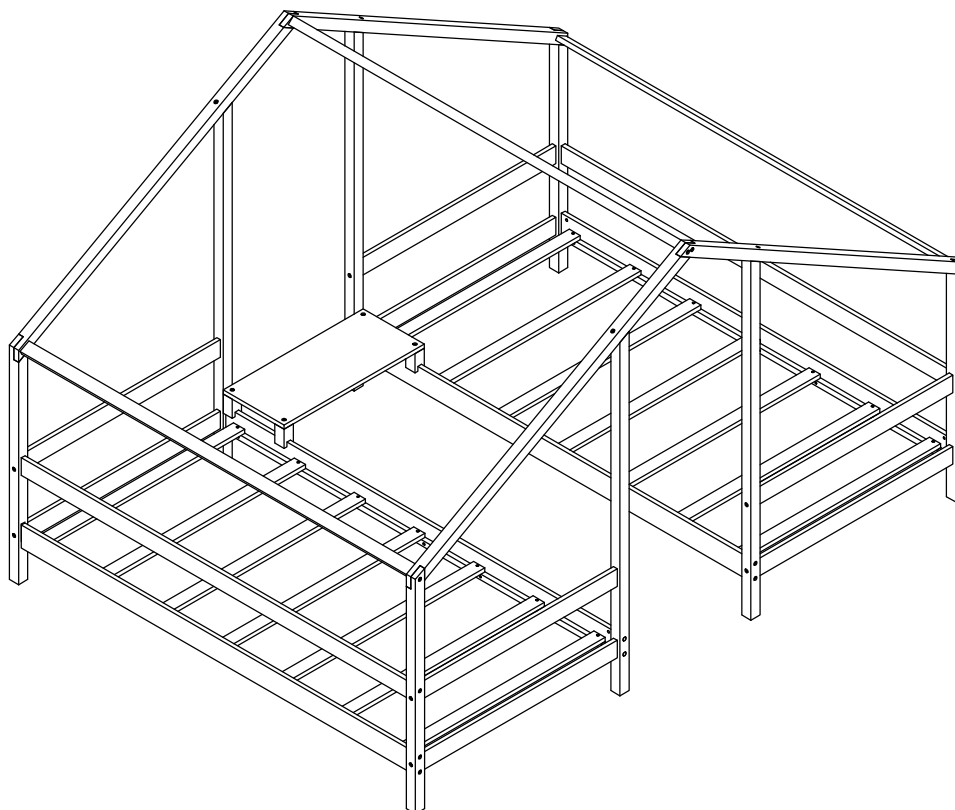

Thank you for purchasing this quality product. Be sure to check all packing material carefully for small parts which may have come loose inside the carton during shipment. Separate, identify and count all parts and hardware. Compare with the parts list to be sure all parts are present.
"DO NOT TIGHTEN SCREWS UNTIL COMPLETELY ASSEMBLED"

*** Use of power tool to assemble this product will invalidate any claim and damage this product making unsafe !!!**
*** Please assemble on a clean soft surface to avoid damage.**

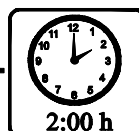
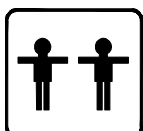

Tools Required

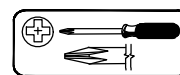

(Not included)

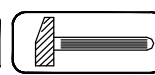

(Not included)

IMPORTANT:



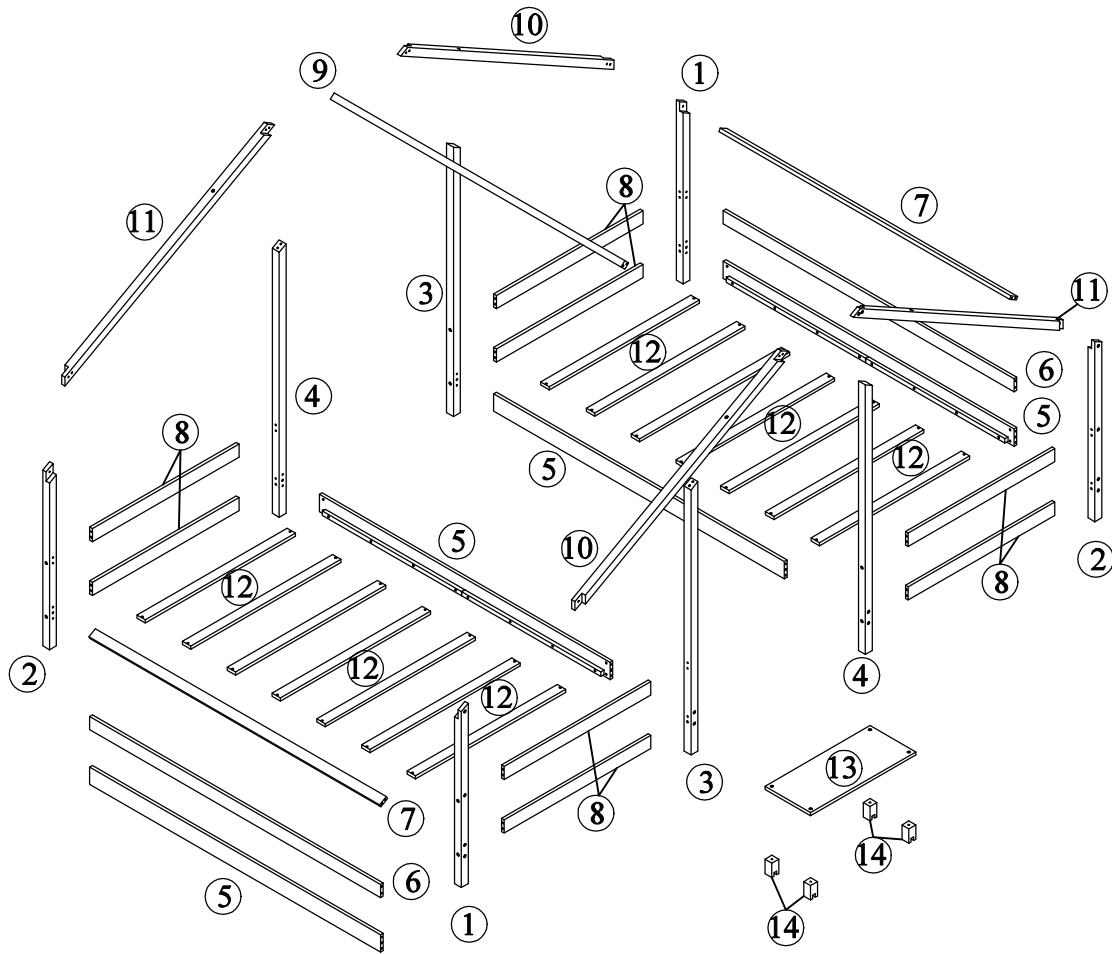

PLEASE READ INSTRUCTION BEFORE STARTING THE ASSEMBLY

Detail View - BED



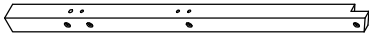
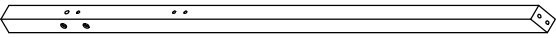
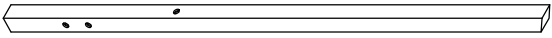
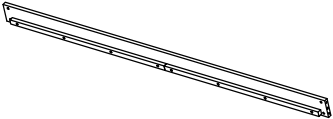

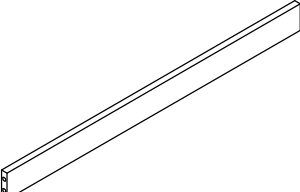
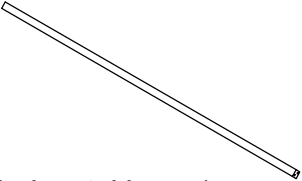
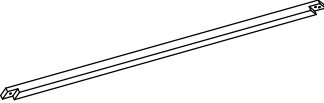
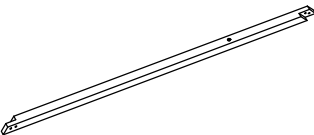
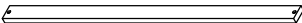
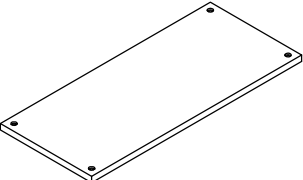

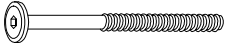

Identifying the Hardware -Identify the hardware using the illustrations below.

Part List—WF286895

<p>1</p>  <p>Bed column - 2pcs</p>	<p>2</p>  <p>Bed column - 2pcs</p>
<p>3</p>  <p>Bed column - 2pcs</p>	<p>4</p>  <p>Bed column - 2pcs</p>
<p>5</p>  <p>Bed side plate - 4pcs</p>	<p>6</p>  <p>Horizontal bar - 2pcs</p>
<p>7</p>  <p>Horizontal bar - 2pcs</p>	<p>8</p>  <p>Horizontal bar - 8pcs</p>
<p>9</p>  <p>Horizontal bar - 1pc</p>	<p>10</p>  <p>Roof connecting bar - 2pcs</p>
<p>11</p>  <p>Roof connecting bar - 2pcs</p>	<p>12</p>  <p>Bed board - 14pcs</p>
<p>13</p>  <p>Panel - 1pc</p>	<p>14</p>  <p>Legs - 4pcs</p>



Hardware List—WF286895

<p>A</p>  <p>$\varnothing 13 \times 1/4" \times 80 \text{mm}$</p>	<p>B</p>  <p>$\varnothing 13 \times 1/4" \times 70 \text{mm}$</p>	<p>C</p>  <p>$\varnothing 13 \times 1/4" \times 35 \text{mm}$</p>
<p>Hex-Head bolts(16pcs)</p>	<p>Hex-Head screw(32pcs)</p>	<p>Hex-Head screw(4pcs)</p>
<p>D</p>  <p>$\varnothing 10 \times 13 \text{mm}$</p>	<p>E</p>  <p>$\varnothing 8 \times \varnothing 4 \times 30 \text{mm}$</p>	<p>F</p>  <p>$\varnothing 10 \times 40 \text{mm}$</p>
<p>Horizontal-Hole bolts(16pcs)</p>	<p>Round head screw(28pcs)</p>	<p>Wood dowel(36pcs)</p>
<p>G</p>  <p>4mm</p> <p>Allen key(1pc)</p>		

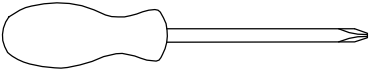
ASSEMBLY TOOLS REQUIRED (NOT INCLUDED)



STEP: 1

B		F	
16PCS		16PCS	

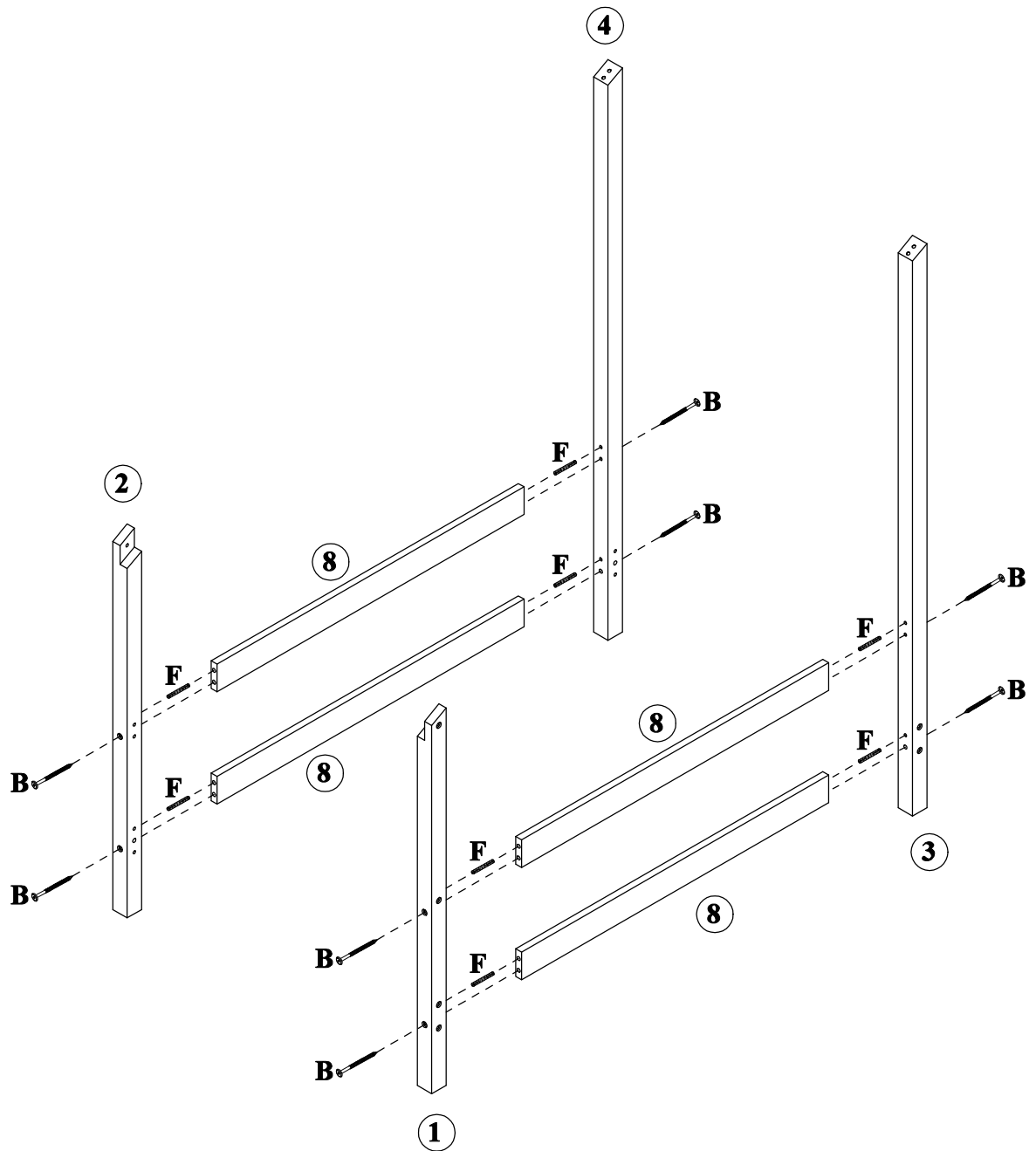

X 2



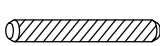

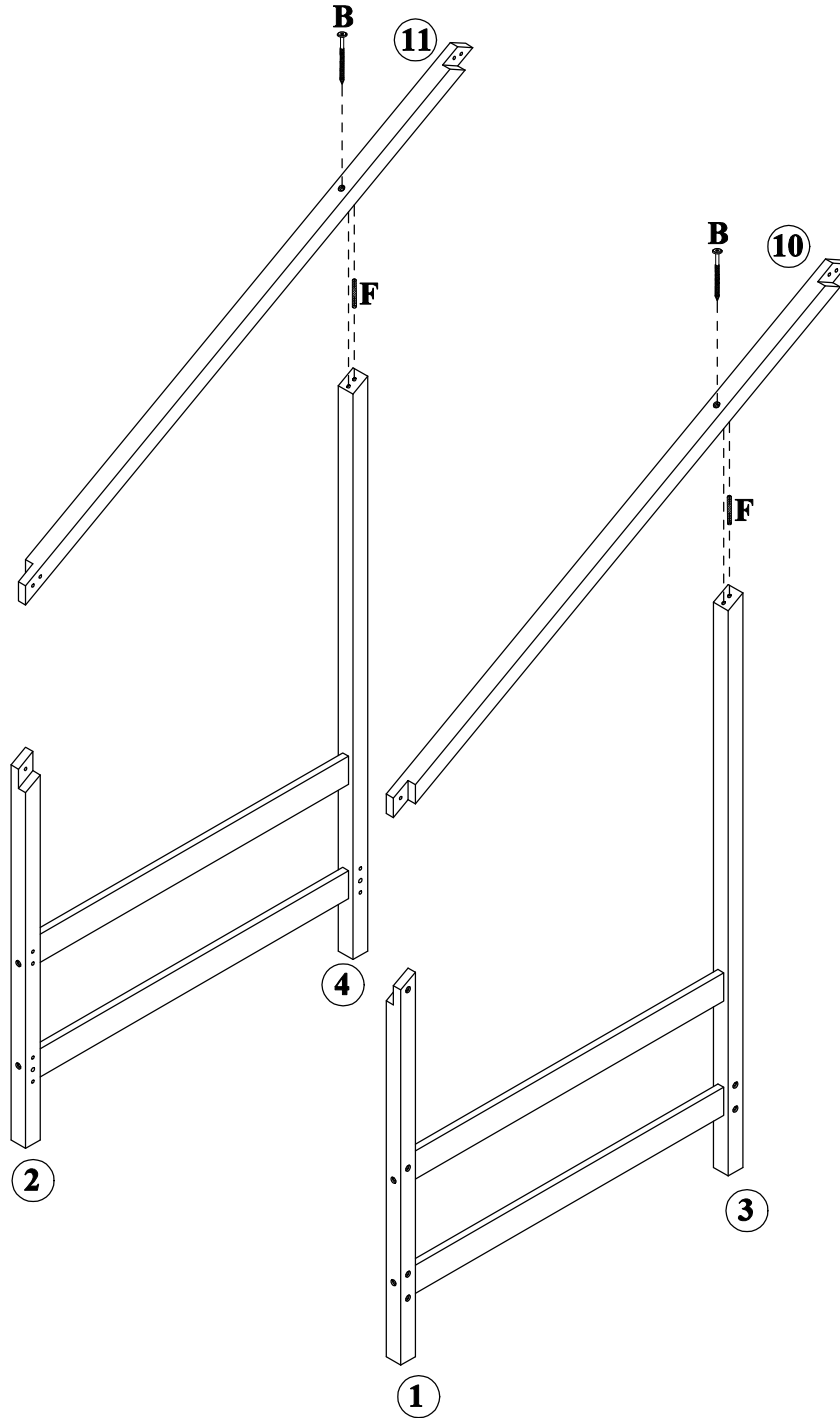
STEP: 2

B	F
	
4PCS	4PCS



X 2

STEP: 3

A	B	D	F
			
16PCS	8PCS	16PCS	16PCS

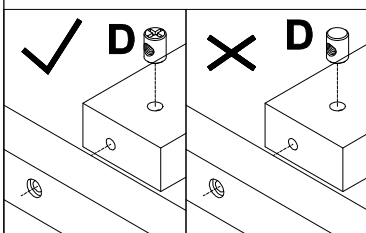
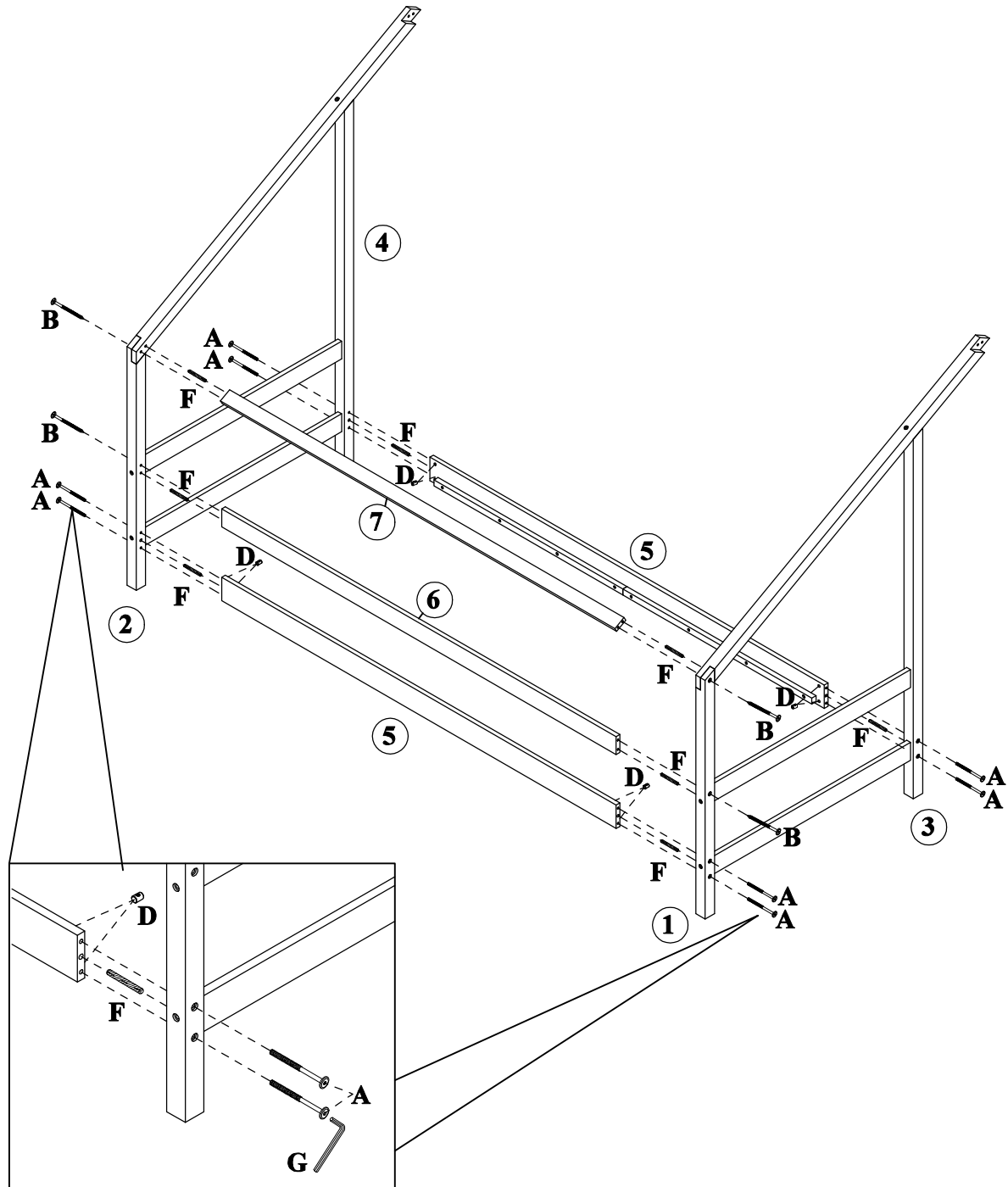

X 2

STEP: 4

B



4PCS

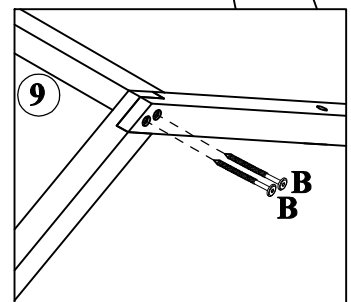
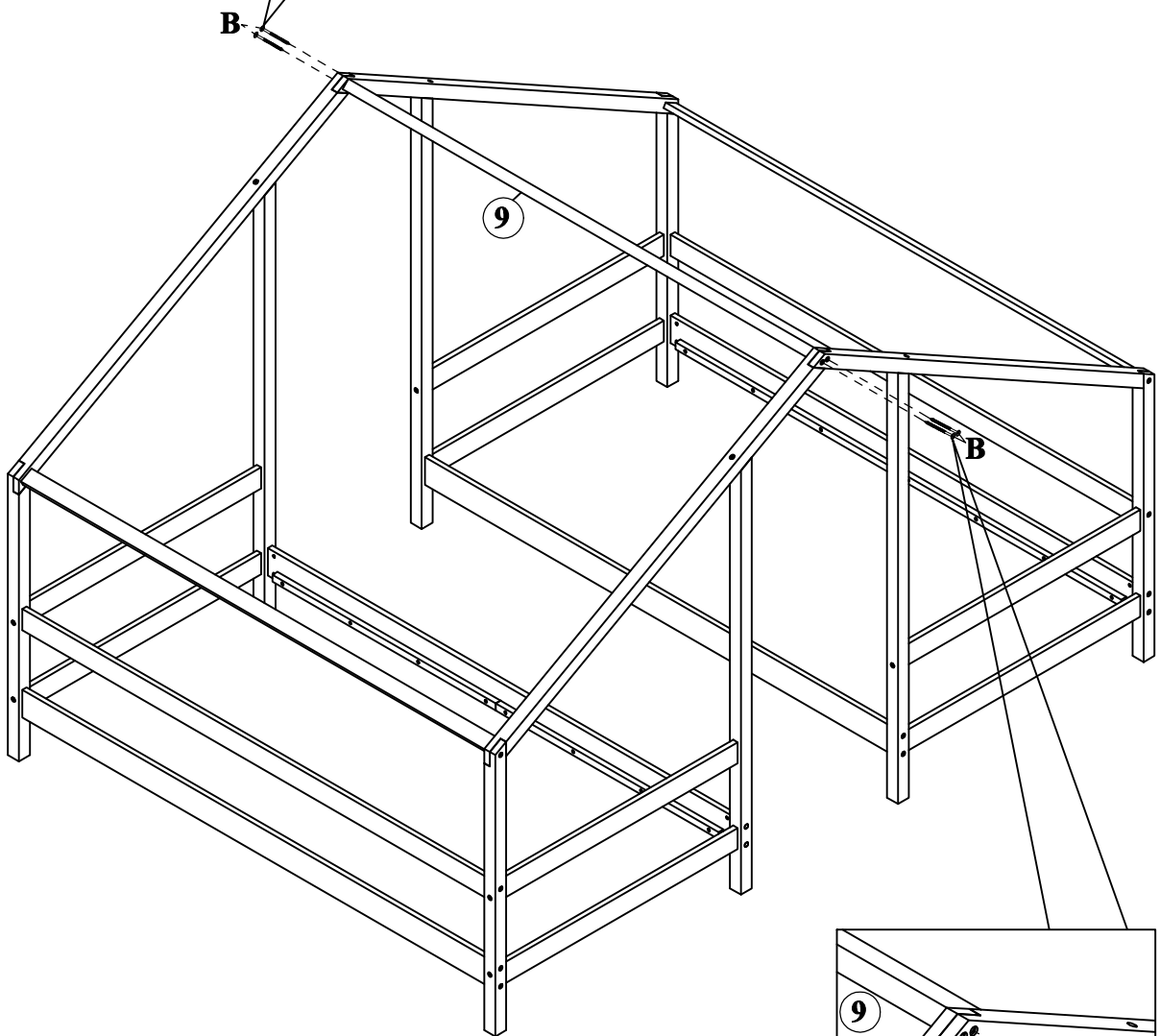
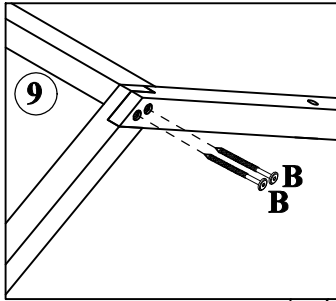

STEP: 5

C



4PCS

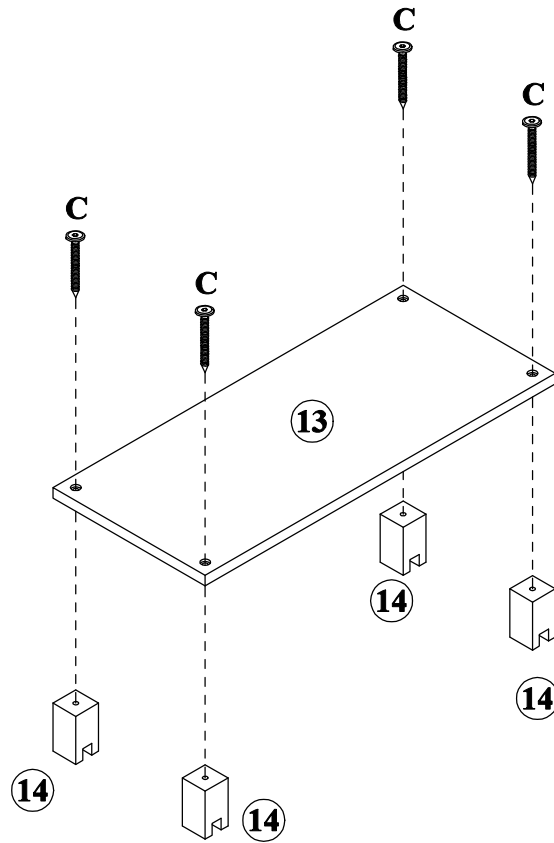

STEP: 6

E



28PCS

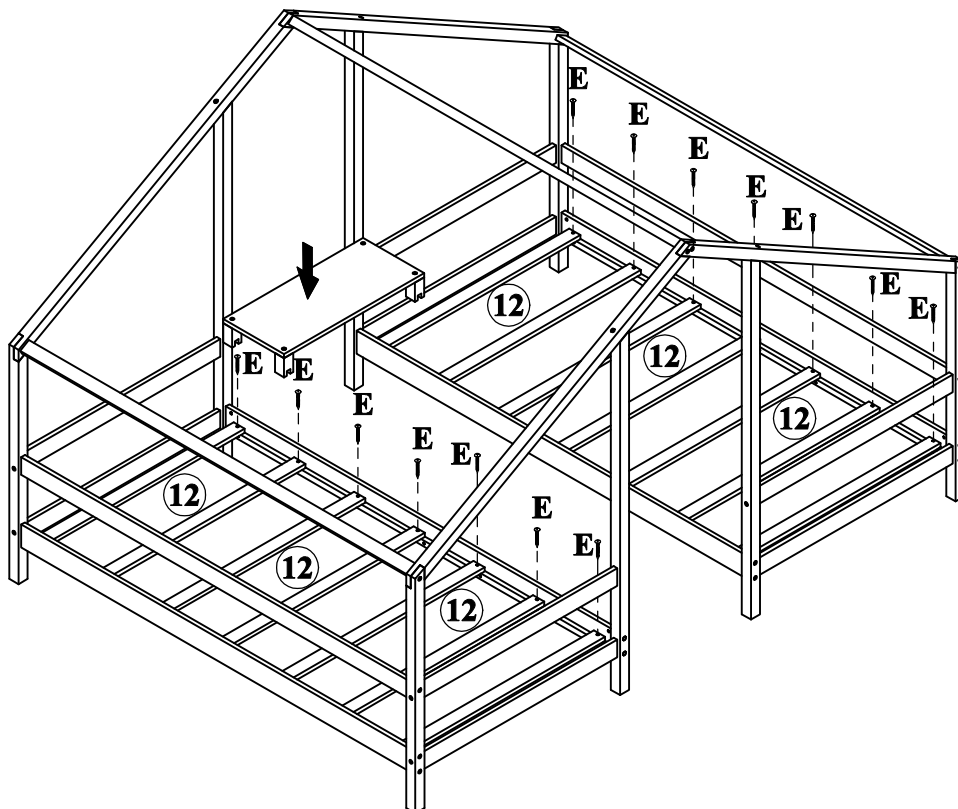

STEP:7

