

*get started*

INSTANT POT® **DUO® PLUS**  
USER MANUAL

Instant®

# Welcome

to your new Instant Pot® Duo® Plus!

This Instant Pot Duo Plus multifunction cooker can help you cook healthy, delicious meals more easily and in less time. We hope you fall in love with Instant Pot cooking, and enjoy it in your kitchen for years to come!

**Get started with your new Duo Plus!**



## CONTENTS

Important safeguards	2
What's in the box	8
Using your Duo Plus	10
Initial setup	14
Using the lid	20
Slow Cook	26
Rice	28
Steam	30
Sauté	31
Yogurt	33
Sous Vide	35
Cake	37
Keep Warm	39
Cleaning	40
Troubleshooting	41
Error codes	43
Learn more	45
Warranty	46

# **IMPORTANT SAFEGUARDS**



## **⚠ WARNING**

# READ ALL INSTRUCTIONS

### **Placement**

**DO** place the appliance on a countertop only. Always operate the appliance on a stable, non-combustible, level surface.

**DO** make sure all parts are dry and free of food debris before placing the cooking pot on the cooker base.

**DO NOT** place the appliance on or close to a hot gas or electric burner, or a heated oven.

**DO NOT** use the appliance near water or flame.

**DO NOT** use outdoors. Keep out of direct sunlight.

**DO NOT** place on anything that may block the vents on the bottom of the appliance.

### **General Use**

The removable inner cooking pot is extremely hot during use, and can be extremely heavy when full of ingredients.

**DO** use oven mitts when handling the inner cooking pot and removing accessories.

**DO** place hot accessories on a heat-resistant surface or cooking plate.

**DO** use care when lifting the cooking pot from the cooker base to avoid burn injury.

**DO** use extreme caution when the cooking pot contains hot food, hot oil or other hot liquids.

## **⚠ WARNING**

**DO** use only the Instant Pot lid that came with this cooker base. Using any other pressure cooker lids may cause personal injury and/or property damage.

**DO NOT** use the appliance without the removable inner cooking pot installed.

**DO NOT** touch the metal portion of the lid, the appliance's hot surfaces, or any accessories during or immediately after cooking because they will be hot. Only use the side handles for carrying or moving.

**DO NOT** use this appliance for deep frying or pressure frying with oil.

**DO NOT** move the appliance while it is in use and use extreme caution when disposing of hot grease.

**DO NOT** allow children or persons with reduced physical, sensory or mental capabilities to operate this appliance. Close supervision is necessary when any appliance is used by or near children and persons with reduced physical, sensory or mental capabilities. Children should not play with this appliance.

**DO NOT** use the appliance for anything other than household use. It is not intended for commercial use.

**DO NOT** leave the appliance unattended while in use.

### **Pressure Cooking**

This appliance cooks under pressure. Allow the appliance to depressurize naturally or release all excess pressure before opening. Inappropriate use may result in burns, personal injury and/or property damage.

**DO** make sure the appliance is properly closed before operating.

**DO** check that the steam release valve is installed.

**DO** use the pressure cooking lid when pressure cooking. *For instructions on how to use the lid, see the User Manual or Getting Started Guide.*

## **⚠ WARNING**

**DO** turn the appliance off if steam escapes from the steam release valve and/or float valve in a steady stream for longer than 3 minutes. If steam escapes from the sides of the lid, turn the appliance off and make sure the sealing ring is properly installed.

**DO** check the steam release valve, steam release pipe, anti-block shield and float valve for clogging before use.

**DO NOT** remove the pressure cooking lid with unprotected hands.

**DO NOT** attempt to force the lid off the Instant Pot cooker base.

**DO NOT** move the appliance when it is under pressure.

**DO NOT** cover or obstruct the steam release valve and/or float valve with cloth or other objects.

**DO NOT** attempt to open the appliance until it has depressurized, and all internal pressure has been released. Attempting to open the appliance while it is still pressurized may lead to sudden release of hot contents and may cause burns, personal injuries and/or property damage.

**DO NOT** place your face, hands or exposed skin over the steam release valve or float valve when the appliance is in operation or has residual pressure, and do not lean over the appliance when removing the lid.

### **Overfill During Pressure Cooking**

Overfilling may cause a risk of clogging the steam release pipe and developing excess pressure.

**DO NOT** fill the inner cooking pot over the line labeled 'PC MAX – 2/3'.

**DO NOT** fill the inner cooking pot over the line labeled '– 1/2' when cooking foods that expand during cooking such as rice, dried beans or dried vegetables.

## **⚠ WARNING**

**DO** be aware that certain foods, such as applesauce, cranberries, pearl barley, oatmeal or other cereals, split peas, noodles, macaroni, rhubarb, or spaghetti can foam, froth, sputter, and clog the pressure release device (steam vent). **DO NOT** fill the cooking pot higher than the "1/2" line when cooking these foods.

**DO NOT** place oversized foods into the inner cooking pot as they may cause risk of fire, personal injury, and property damage.

**DO** check that the sealing ring is properly installed.

### **Accessories**

**DO** use only accessories or attachments authorized by Instant Brands. The use of parts, accessories or attachments not recommended by the manufacturer may cause a risk of personal injury, property damage, fire, or electric shock.

**DO** use only an authorized stainless-steel Instant Pot inner cooking pot to reduce the risk of pressure leakage.

**DO** only replace the sealing ring with an authorized Instant Pot sealing ring to prevent personal injury, property damage and damage to the appliance.

**DO NOT** use the included accessories in a microwave, toaster oven, convection or conventional oven, or on a ceramic cooktop, electric coil, gas range or outdoor grill.

### **Care and Storage**

**DO** let the appliance cool to room temperature before cleaning or storage.

**DO NOT** store any materials, other than the multicooker cooking pot, in the cooker base when not in use.

**DO NOT** place any combustible materials in the cooker base, such as paper, cardboard, plastic, Styrofoam or wood.

## **⚠ WARNING**

### **Power Cord**

A short power-supply cord is used to reduce the risk resulting from it being grabbed by children, becoming entangled in, or tripping over a longer cord.

**WARNING:** Spilled food can cause serious burns. Keep appliance and cord away from children. Never drape cord over edge of counter, never use outlet below counter, and never use with an extension cord.

**DO NOT** let the power cord touch hot surfaces or open flame, including the stovetop.

**DO NOT** use with power converters or adapters, timer switches or separate remote-control systems.

This appliance has a 3-prong grounding plug. To reduce the risk of electric shock:

**ONLY** plug the power cord into a grounded electrical outlet.

**DO NOT** remove ground.

If the unit includes a detachable power cord:

To connect, always attach the power cord to the appliance first, then plug the power cord into the wall outlet.

### **Electrical Warning**

The cooker base contains electrical components that are an electrical shock hazard. Failure to follow these instructions may result in electric shock.

To protect against electrical shock:

To disconnect, select **Cancel**, then remove plug from power source. Always unplug when not in use, as well as before adding or removing parts or accessories, and before cleaning. To unplug, grasp the plug and pull from the outlet. Never pull from the power cord.



## **⚠ WARNING**

**DO** regularly inspect the appliance and power cord. **DO NOT** operate the appliance if the power cord or plug is damaged, or after the appliance malfunctions or is dropped or damaged in any manner. For assistance, contact Customer Care by email at [support@instanthome.com](mailto:support@instanthome.com).

**DO NOT** attempt to repair, replace or modify components of the appliance, as this may cause electric shock, fire, personal injury, and/or property damage and will void the warranty.

**DO NOT** tamper with any of the safety mechanisms, as this may result in personal injury or property damage.

**DO NOT** put liquid or food of any kind into cooker base without the inner cooking pot.

**DO NOT** immerse power cord, plug or the appliance in water or other liquid.

**DO NOT** use the appliance in electrical systems other than 120 V ~ 60 Hz for North America.

**DO NOT** clean the appliance by rinsing it under a faucet.

# **SAVE THESE INSTRUCTIONS**

# WHAT'S IN THE BOX

## Lid

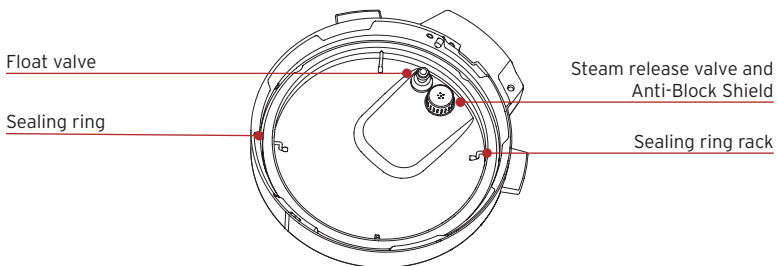
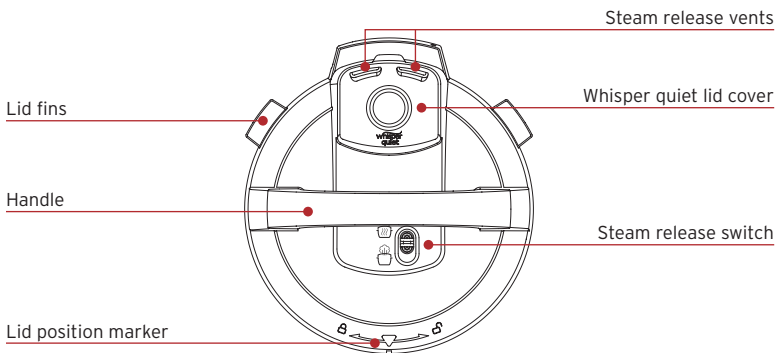

## Stainless Steel Inner Cooking Pot

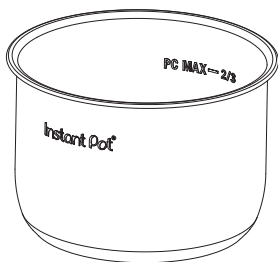

## Cooker Base

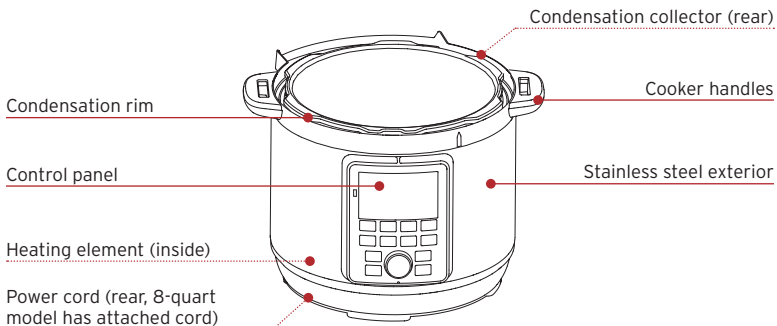

## Parts + Accessories

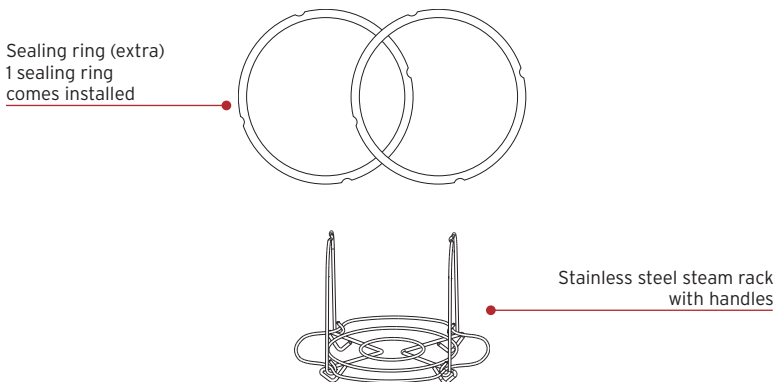

*Illustrations are for reference only and may differ from the actual product.*

## Remember to recycle!

We designed this packaging with sustainability in mind. Please recycle everything that can be recycled where you live.

# USING YOUR DUO PLUS

## Control panel

We've designed the control panel to be simple to use and easy to read.

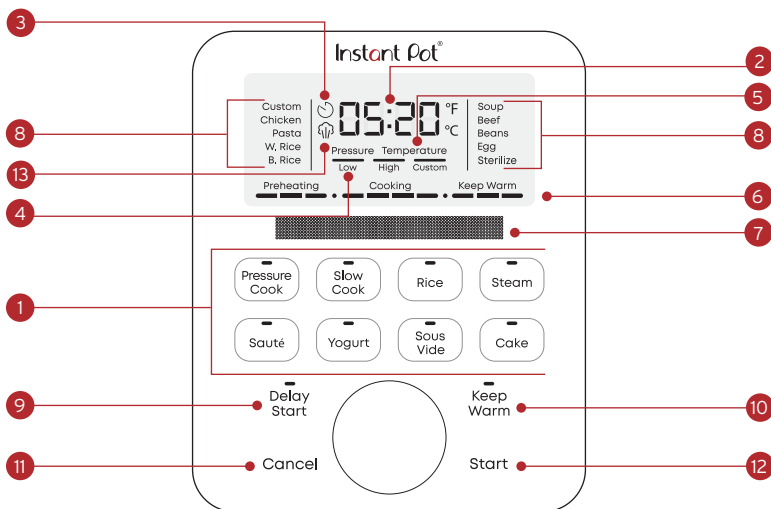

1. Smart Program Settings
  - Cooking presets
2. Time
  - Cooking time
  - Delay Start time
  - Keep Warm time
3. Delay Start Indicator
  - Shows Delay Start is active
4. Pressure Indicator
  - When lit, shows the pressure level selected
5. Temperature Indicator
  - When lit, shows the temperature selected
6. Progress Bar
  - Shows cooking progress
7. Message Display
  - Shows cooking instructions
8. Cooking Programs
  - Active program will be lit
9. Delay Start
  - Light shows ON
10. Keep Warm
  - Light shows ON
11. Cancel
12. Start
13. Steam Icon
  - When lit, there is pressure in the multi-cooker

## Status messages

The control panel shows information you need to know when using your Instant Duo Plus.

OFF	Standby mode
On	Preheat mode
Hot	Sauté Smart Program is ready to add food
00:00	Time <ul style="list-style-type: none"><li>• Smart Program: cooking time remaining</li><li>• Delay Start: time until Smart Program starts</li><li>• Keep Warm: time food has been warming</li></ul>
boil	Yogurt Smart Program is in pasteurizing cycle
End	Smart Program ended (Keep Warm is off)
Lid	Lid is not on the unit or is not properly secured
Food	The cooker is overheating due to insufficient liquid. See <b>Troubleshooting</b> .
burn	The cooker is overheating due to insufficient liquid. See <b>Troubleshooting</b> .
E*	An error has occurred. See <b>Troubleshooting</b> .

## Turning the sound On or Off

### Turn sound on

When in Ready mode, press and hold **Delay Start** and **Keep Warm** for 5 seconds. The message display shows **Sound Off**.

### Turn sound off

When in Ready mode, press and hold **Delay Start** and **Keep Warm** for 5 seconds. The message display shows **Sound On**

*Audible safety alerts (beeps) cannot be turned off.*

## Changing the temperature scale

### Set to Fahrenheit

When in Ready mode (and scale is set to Celsius), press and hold the **Control Dial** for 5 seconds. The message display shows **Temp Unit F**.

### Set to Celsius

When in Ready mode (and scale is set to Fahrenheit), press and hold the **Control Dial** for 5 seconds. The message display shows **Temp Unit C**.

## Delay the start of cooking

You can set a Delay Start timer for a minimum of 10 minutes or a maximum of 24 hours.

1. Select a Smart Program, adjust the settings as you want, then press **Delay Start**.
2. When the minutes field flashes, turn the **Control Dial** to set the minutes (in 10 minute increments) and press the **Start** to select.
3. Delay Start begins automatically and the timer counts down.
4. When Delay Start ends, the Smart Program begins.

## Set a timer (without cooking)

You can set a timer for a minimum of 1 minute or a maximum of 60 minutes.

1. When the unit is on and the message display shows **Ready**, press **Delay Start**.
2. When the minutes field flashes, turn the **Control Dial** to set the minutes (in 1 minute increments).
3. Press **Start** to begin the timer.

## Cancel cooking

When in Preheating, Cooking or Keep Warm modes, press **Cancel**. The message display shows **Ready**.

## Reset unit to original settings

### Reset individual programs

- With the cooker in Ready mode, press and hold one program button for over 3 seconds. The message display shows **Ready**.

*The Program's pressure level, cooking time and temperature are restored to the factory default setting.*

### Reset individual programs during cooking

- With the cooker in Cooking mode, press and hold that program's button for over 3 seconds. The display returns to the Cooking program in progress, but with the factory default settings.

*The Program's pressure level, cooking time and temperature are restored to the factory default setting.*

### Reset all program settings

- With the cooker in Ready mode, press and hold **Cancel** for over 3 seconds. The message display shows **Ready**.

*The unit's settings are restored to the factory default.*

# INITIAL SETUP

## Clean before use

1. Wash the inner cooking pot with hot water and soap. Rinse and use a soft cloth to dry the outside. Or you can wash the inner cooking pot in the dishwasher.
2. Wipe the heating element inside the cooker base with a soft cloth to ensure there are no stray packaging particles.

## Setting up the condensation collector

The condensation collector sits at the back of the cooker base and accumulates overflow moisture from the condensation rim. It should be installed before cooking, then emptied and rinsed out after each use.

## Remove the condensation collector

- Pull the condensation collector away from the cooker base; do not pull down.

*Note the tabs on the cooker base and the grooves on the condensation collector.*

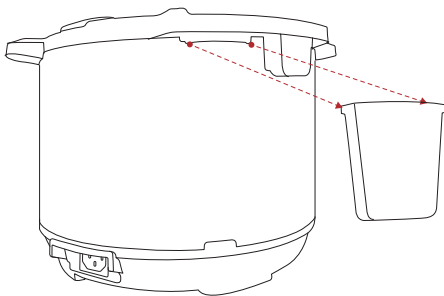



## Install the condensation collector

- Align the grooves on the condensation collector with the tabs on the back of the cooker base and slide the condensation collector into place.

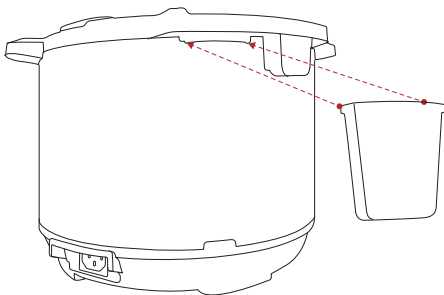

## Using the Sealing Ring

When the lid is closed, the sealing ring installed on the underside of the lid creates an air-tight seal between the lid and the cooker base.

- The sealing ring must be installed before using the cooker and should be cleaned after each use.
- Install 1 sealing ring at a time; use one for sweet dishes and one for savory.
- Sealing rings stretch over time with normal use. To keep your product safe, replace the sealing ring every 12 to 18 months. Replace sooner if you notice stretching, deformation, or damage.

## Install the Sealing Ring

1. Place the sealing ring over the sealing ring rack and press it into place. Press down firmly to ensure there is no puckering.
2. The sealing ring should be snug and should not fall out when the lid is turned over.

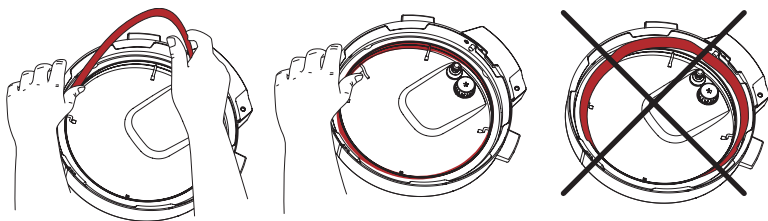

## Remove the Sealing Ring

1. Grip the edge of the sealing ring and pull it out from behind the sealing ring rack.
2. Inspect the rack to ensure it is secured, centered, and an even height all the way around the lid. If the sealing ring rack is deformed, do not try to repair it.

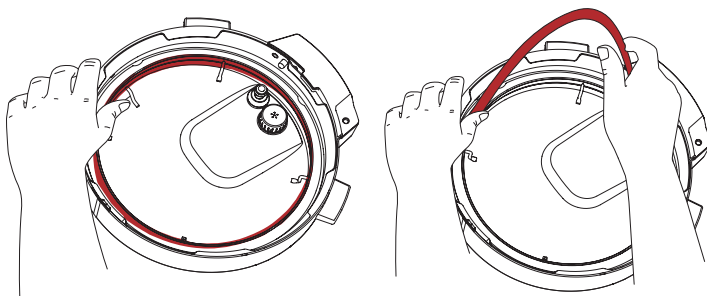

## Anti-Block Shield

The anti-block shield prevents food particles from coming up through the steam release pipe, assisting with pressure regulation.

As an integral part of product safety, the anti-block shield must be installed before use and cleaned frequently.

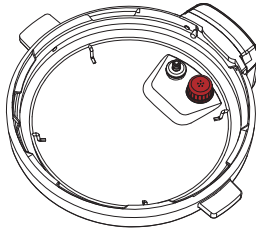

### Remove the Anti-Block Shield

- Grip the lid like a steering wheel and use your thumbs to press firmly against the side of the anti-block shield (pressing towards the side of the lid and up) until it pops off the prongs underneath.

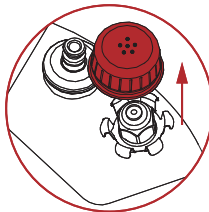

## Install the Anti-Block Shield

- Place anti-block shield over prongs and press down until it snaps into position. Do not attempt to operate the pressure cooker without the anti-block shield installed.

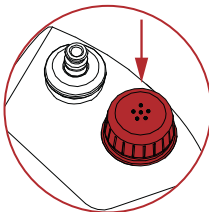

## Plug in cord (6QT model)

- When you're ready to use your Instant Pot Duo Plus, plug the electrical cord into the power socket on the back of the unit.

*The 8QT model has an electrical cord that is always connected to the unit.*

## Test run

Setting up your new Instant Pot Duo Plus for a test run is a great way to familiarize yourself with how the unit works before you actually cook a meal.

### To perform a test run:

1. Add 3 cups water to the inner cooking pot.
2. Place the inner cooking pot into the cooker base.
3. Place the lid on top of the cooker base and lock the lid.  
*See 'How to lock the lid' below*
4. Press **Pressure Cook** on the Control Panel.
5. Press the **Control Dial**, then turn the **Control Dial** to set the cooking time to 5 minutes.
6. Press **Keep Warm** to turn off the Keep Warm setting.
7. Press **Start** to begin. The message display shows **Preheating**.
8. When cooking is done, the display shows **DO NOT OPEN LID**.
9. Release steam by moving the steam release switch to the **Vent**  position. When steam is completely released, the message display shows **OK to Open Lid** and **End** alternatively.  
*See 'How to release steam' below for complete instructions*
10. Unlock and open the lid.  
*See 'How to unlock the lid' below*
11. Discard any remaining water, and then wash and dry the inner cooking pot.

*Now you're ready to cook a meal in your Instant Pot Duo Plus!*

## USING THE LID

You'll use the pressure cooking lid for most cooking programs, and especially for pressure cooking. Always use the pressure cooking lid that came with this Instant Pot Duo Plus cooker base.

### How to close and lock the lid

For pressure cooking, the lid must be securely locked into place to prevent steam from escaping. When you place the lid on the cooker base:

1. Line up line on the lid with the arrow at the side of the control panel .

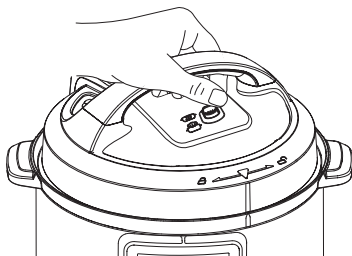

2. Turn the lid clockwise until the line on the lid lines up with the line on the control panel.

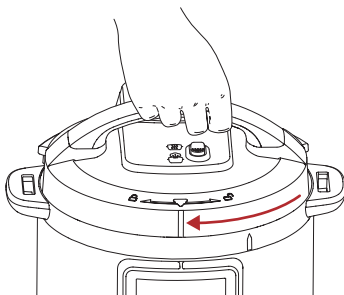

*If the lid is not closed and locked when you start a cooking program, the message display will show **Turn to Lock Lid** and the unit will not start pressurizing.*

## How to unlock and open the lid

Once steam is completely released, you must unlock the lid before opening it:

1. Turn the lid counterclockwise until the line on the lid lines up with the arrow on the side of the control panel.

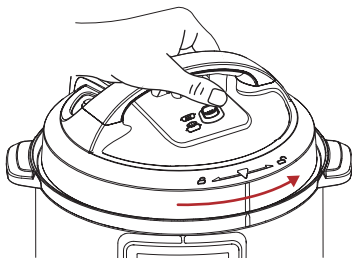

2. Carefully lift the lid up and off the cooker base.

*When a cooking program is finished and steam has been released, the steam icon on the display  will disappear and the message display will show **END** and **OK to Open Lid**.*

## How to release steam

Instant Pot Duo Plus can release steam naturally or quickly. Use the one that best fits the type of food you're cooking.

### Natural steam release

1. After cooking, leave the steam release switch in the Seal position  until all pressure is released.

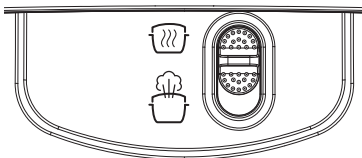



2. When pressure is released the steam icon on the display  disappears and the message display shows **OK to Open Lid**, remove the lid.

### Quick steam release

Quickly releases steam after you move the steam release switch to the Vent position. Use for: Foods that tend to overcook, like vegetables and seafood.

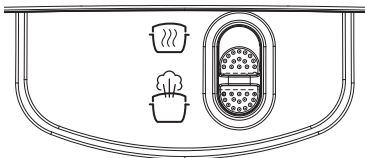
1. After cooking, set steam release switch to **Vent** position  position and wait for all pressure to release.



2. When pressure is released, the steam icon on the display  will disappear and the message display shows **OK to Open Lid**, remove the lid.

### Pressure Cooking Caution

This appliance uses pressure to cook. Allow the appliance to release all excess pressure and steam before opening the lid. Opening the lid before pressure is released may result in burns, personal injury and/or property damage. Read more in the Safety, Maintenance and Warranty document.



## Pressure Cook

Pressure cooking uses pressurized steam to cook foods quickly and evenly. Each specific Smart Program is designed to pressure cook a specific type of food. You can adjust the settings as your recipe directs.

Choose from these Smart Programs:

Program	Default Cook Time	Min Cook Time	Max Cook Time	Default Pressure Level
Custom	10 minutes (00:10)	0 minute (00:00)	8 hours (08:00)	High
Chicken	10 minutes (00:10)	0 minute (00:00)	4 hours (04:00)	High
Pasta	1 minute (00:01)	0 minute (00:00)	1 hour (01:00)	High
Soup	30 minutes (00:30)	0 minute (00:00)	4 hours (04:00)	High
Beef	30 minutes (00:30)	0 minute (00:00)	4 hours (04:00)	High
Beans	20 minutes (00:20)	0 minute (00:00)	4 hours (04:00)	High
Egg	5 minutes (00:05)	0 minute (00:00)	10 minutes (00:10)	Low
Sterilize	10 minutes (00:10)	0 minute (00:00)	30 minutes (00:30)	High

### Other settings

- Automatic Keep Warm is set to ON by default for all Pressure Cook programs.
- Delay Start is available for all Pressure Cook programs.

## How to pressure cook

### Prep

Cut, chop, season or marinate your ingredients according to your recipe.

### Preheat

1. Add ingredients to the inner cooking pot and place the inner cooking pot into the cooker base.
2. Place the lid on top of the cooker base and lock the lid.
3. Press **Pressure Cook** on the Control Panel.
4. Turn the **Control Knob** to highlight the Smart Program you want to use, then press the **Control Knob** to select it.
5. The default cooking time flashes. To select it, press the **Control Dial**. Or turn the **Control Dial** to change it, then press the **Control Dial** to select it.
6. The default pressure level flashes. To select it, press the **Control Dial**. Or turn the **Control Dial** to change it, then press the **Control Dial** to select it.
7. To delay cooking, press **Delay Start**, then turn the **Control Knob** to select the delay time.
8. Keep Warm setting is ON by default. Press **Keep Warm** to turn it off.
9. Press **Start**. The message display shows **Preheating** and the unit builds pressure.

*It can take 10-15 minutes to reach the pressure setting for cooking. Frozen foods increase the preheating time.*

### Cook

1. When the pressure is ready, the message display shows **Do Not Open Lid**. Cooking starts, and the progress bar shows **Cooking**.
2. The cooking time starts counting down.

*You can press Cancel to stop cooking at any time.*

## Stop cooking

1. When cooking time reaches 00:00, cooking stops.
2. If Keep Warm is ON, the time starts counting up.

## Release steam

Choose the steam release method that works for your recipe.

See 'How to release steam' above for full details.

## Using liquid to create steam

Pressure cooking requires liquid in the inner cooking pot to produce the steam needed. Depending on the size of your Instant Pot Duo Plus, here are the minimum amounts you'll need:

Instant Pot Size	Minimum Liquid for Pressure Cooking*
6 Quarts / 5.7 Litres	1 1/2 cups (12 oz / 375 mL)
8 Quarts / 7.6 Litres	2 cups (16 oz / 500 mL)

*\*Unless otherwise specified in recipe.*

*Pressure cooking liquids should be water-based, such as broth, stock, soup or juice. If using canned, condensed, or cream-based soup, add water as directed above.*

## SLOW COOK

Slow cooking lets you make your favorite simmering and stewing recipes – just like grandma used to make. This program does not use pressure to cook food.

Choose from these Smart Programs:

Program	Default Cook Time	Min Cook Time	Max Cook Time	Default Temperature
Custom	4 hours (04:00)	30 minutes (00:30)	99 hours, 30 minutes (99:30)	High
Chicken	4 hours (04:00)	30 minutes (00:30)	99 hours, 30 minutes (99:30)	High
Pasta	3 hours (03:00)	30 minutes (00:30)	99 hours, 30 minutes (99:30)	High
Soup	6 hours (06:00)	30 minutes (00:30)	99 hours, 30 minutes (99:30)	High
Beef	6 hours (06:00)	30 minutes (00:30)	99 hours, 30 minutes (99:30)	High
Beans	8hours (08:00)	30 minutes (00:30)	99 hours, 30 minutes (99:30)	High

### Other settings

- Automatic Keep Warm is set to ON by default for all Slow Cook programs.
- Delay Start is available for all Slow Cook programs.

## How to slow cook

### Prep

Cut, chop, season or marinate your ingredients according to your recipe.

### Cook

1. Add ingredients to the inner cooking pot and place the inner cooking pot into the cooker base.
2. Place the lid on top of the cooker base and lock the lid.
3. Press **Slow Cook**.
4. Turn the **Control Knob** to highlight the Smart Program you want to use, then press the **Control Knob** to select it.
5. The default cooking time flashes. To select it, press the **Control Dial**. Or to change it, turn the **Control Dial** to change it, then press the dial to select it.
6. The default cooking temperature flashes. To select it, press the **Control Dial**. Or to change it, turn the **Control Dial** to change it.
7. You can delay cooking if you want. Press **Delay Start**, then turn the **Control Knob** to select the delay time.
8. Keep Warm setting is ON by default. Press **Keep Warm** to turn it off.
9. Press Start. Preheating starts. When ready, cooking starts, and the progress bar shows **Cooking**.
10. The cooking time starts counting down.

*You can press Cancel to stop cooking at any time.*

### Stop cooking

1. When cooking time reaches 00:00, cooking stops.
2. If Keep Warm is ON, the time starts counting up.

## RICE

The Rice program uses pressurized steam to cook rice quickly and evenly. You can adjust the settings as your recipe directs.

Choose from these Smart Programs:

Program	Default Cook Time	Min Cook Time	Max Cook Time	Default Pressure Level
Custom	12 minutes (00:12)	0 minute (00:00)	1 hour (01:00)	Low
White Rice	12 minutes (00:12)	0 minute (00:00)	30 minutes (00:30)	Low
Brown Rice	30 minutes (00:30)	0 minute (00:00)	1 hour (01:00)	High

### Other settings

- Automatic Keep Warm is set to ON by default for all Rice programs.
- Delay Start is available for all Rice programs.

### How to cook rice

1. Add ingredients to the inner cooking pot and place the inner cooking pot into the cooker base.
2. Place the lid on top of the cooker base and lock the lid.
3. Press **Rice** on the Control Panel.
4. Turn the **Control Knob** to highlight the Smart Program you want to use, then press the **Control Knob** to select it.
5. The default cooking time flashes. To select it, press the **Control Dial**. Or to change it, turn the **Control Dial** to change it, then press the dial to select it.
6. The default pressure level flashes. To select it, press the **Control Dial**. Or to change it, turn the **Control Dial** to change it.
7. You can delay cooking if you want. Press **Delay Start**, then turn the **Control Knob** to select the delay time.

8. Keep Warm setting is ON by default. Press **Keep Warm** to turn it off.
9. Press **Start**. The message display shows **Preheating** and the unit builds pressure.

*It can take 10-15 minutes to reach the pressure setting for cooking.*

## **Cook**

1. When the pressure is ready, the message display shows **Do Not Open Lid**. Cooking starts, and the progress bar shows **Cooking**.
2. The cooking time starts counting down.

*You can press Cancel to stop cooking at any time.*

## **Stop cooking**

1. When cooking time reaches 00:00, cooking stops.
2. If Keep Warm is ON, the time starts counting up.

## **Release steam**

Choose the steam release method that works for your recipe.

*See 'How to release steam' above for full details*

## STEAM

The Steam program cooks food using steam but no pressure; it's especially useful for vegetables like broccoli, zucchini, carrots, and others. You can adjust the settings as your recipe directs or to your taste.

Program	Default Cook Time	Min Cook Time	Max Cook Time	Default Temperature
Custom	10 minutes (00:10)	1 minute (00:01)	1 hour (01:00)	High

### Other settings

- Automatic Keep Warm is not available.
- Delay Start is not available.

### How to steam

#### Prep

Cut or chop the ingredients according to your recipe.

#### Cook

1. Add ingredients to the inner cooking pot and place the inner cooking pot into the cooker base.
2. Place the lid on top of the cooker base and lock the lid.
3. Press **Steam** and 'Custom' flashes on the control panel.
4. The default cooking time flashes. To select it, press the **Control Dial**. Or to change it, turn the **Control Dial** to change it, then press the dial to select it.
5. The default cooking temperature flashes. To select it, press the **Control Dial**. Or to change it, turn the **Control Dial** to change it.
6. Press **Start**. Preheating starts. When ready, cooking starts, and the progress bar shows **Cooking**.
7. The cooking time starts counting down.

*You can press Cancel to stop cooking at any time.*

#### Stop cooking

- When cooking time reaches 00:00, cooking stops.



## SAUTÉ

Use Sauté in place of a frying or saucepan. Sautéing can deepen the flavors of your food, or can simmer, thicken or reduce sauces.

Choose from these Smart Programs:

Program	Cook Temperature (Fixed)	Default Cook Time	Min Cook Time	Max Cook Time
Low	221° F (105° C)	30 minutes (00:30)	1 minute (00:01)	1 hour (01:00)
High	375° F (190° C)	30 minutes (00:30)	1 minute (00:01)	1 hour (01:00)
Custom 1	203° F (95° C)	30 minutes (00:30)	1 minute (00:01)	1 hour (01:00)
Custom 2	230° F (110° C)	30 minutes (00:30)	1 minute (00:01)	1 hour (01:00)
Custom 3	275° F (135° C)	30 minutes (00:30)	1 minute (00:01)	1 hour (01:00)
Custom 4	320° F (160° C)	30 minutes (00:30)	1 minute (00:01)	1 hour (01:00)
Custom 5	375° F (190° C)	30 minutes (00:30)	1 minute (00:01)	1 hour (01:00)

### Other settings

- Automatic Keep Warm is OFF by default.
- Delay Start is not available.

## How to sauté

### Prep

Cut, chop, season or marinate your ingredients according to your recipe.

### Preheat

1. Place the empty inner cooking pot into the cooker base. Do not close the lid.
2. Press **Saute** and the Custom Smart Program flashes.

3. The default cooking time flashes. To select it, press the **Control Dial**. Or to change it, turn the **Control Dial** to change it, then press the dial to select it.
4. The default cooking temperature flashes. To select it, press the **Control Dial**. Or to change it, turn the **Control Dial** to change it.
5. Press **Start**. Cooking starts, and the progress bar shows **Preheating**.

## Cook

1. When the message display shows **Hot**, add the ingredients but do not close the lid.
2. The cooking time starts counting down.

*You can press Cancel to stop cooking at any time.*

## Stop cooking

- When cooking time reaches 00:00, cooking stops.

## Sautéing before Pressure or Slow Cooking

Quite often, you'll want to sauté foods to brown them before further cooking them.

1. Sauté ingredients
2. Press **Cancel**

*You can deglaze the inner cooking pot now before switching to **Pressure Cook** or **Slow Cook** (see **Deglazing** below)*

3. Select the Smart Program you want to use to finish cooking.

## Deglazing

Deglazing is the process of adding a liquid to a hot pan, releasing all of the delicious, caramelized pieces stuck to the bottom.

1. Remove food from inner pot
2. Add water, broth, or wine
3. Use wooden spoon or silicone spatula to loosen food stuck to bottom of the inner cooking pot

# YOGURT

You can use your Instant Pot Duo Plus to easily make delicious, fermented dairy and non-dairy yogurt.

Choose from these settings in the Yogurt Smart Program:

Process	Default Cook Time	Default Temperature	Custom Time Range
Pasteurize	3 minutes (00:03)	High	NA
Ferment (dairy)	8 hours (08:00)	Low	NA
Ferment (non-dairy, custom)	8 hours (08:00) (adjustable)	Low (adjustable)	Minimum 30 minutes (00:30) Maximum 99 hours, 30 minutes (99:30)

## Other settings

- Automatic Keep Warm not available.
- Delay Start is not available.

## How to make yogurt

### Pasteurizing Milk

1. Add milk to the inner cooking pot and place the inner cooking pot into the cooker base.
2. Place the lid on top of the cooker base and lock the lid.
3. Press **Yogurt** and the Custom Smart Program flashes.
4. The default cooking time flashes. Press the **Control Dial** to select a custom setting.
5. Using the **Control Dial**, change the default temperature to High. The display shows **bOIL**.
6. Press **Start**. Cooking starts, and the progress bar shows **Preheating**.
7. When pasteurization finishes, display shows **End**.

*Milk must reach a minimum of 161°F / 72°C for pasteurization to occur.*

## Adding Culture/Starter

1. Allow pasteurized milk to cool to 43°C / 110°F.
2. Add a starter culture to the milk according to package instructions.  
*If using plain yogurt as a starter, ensure that it contains an active culture. Mix in 2 tbsp (30 mL) of yogurt per 1 gallon (3.7 L) of milk or follow a trusted recipe.*
3. Place and close lid.

## Ferment

1. Press **Yogurt**.
2. Cycle to Normal by pressing **Yogurt** again; display shows 8 hours (08:00).
3. The default fermentation time flashes. To select it, press the **Control Dial**. Or to change it, turn the **Control Dial** to change it, then press the dial to select it.
4. After 10 seconds the cooker begins heating; display shows timer counting up from 00:00.
5. When fermentation completes, the unit beeps and the display shows **End**.  
*A longer fermentation period will produce tangier yogurt.*
6. Allow yogurt to cool.
7. Place in the fridge for 12-24 hours to develop flavors.

## How much to make?

Instant Pot Size	Minimum Milk Volume	Maximum Milk Volume
6 Quarts / 5.7 Liters	4 Cups (32 oz / 1000 mL)	4 Quarts (128 oz / 3.8 L)
8 Quarts / 7.6 Liters	6 Cups (48 oz / 1500 mL)	6 Quarts (192 oz / 5.7 L)

## SOUS VIDE

Sous Vide cooks food underwater in an air-tight, food-safe bag, for a long period of time. Food cooks in its own juices and comes out delicious and very tender. This program does not use pressure to cook food.

*You should use the pressure cooking lid to maintain an accurate temperature.*

Choose from these Smart Programs:

Program	Default Temperature	Default Cook Time	Max Cook Time
Custom	56°C 133°F	3 hours (03:00)	99 hrs, 30 min (99:30)
Chicken	60°C 140°F	2 hours (02:00)	99 hrs, 30 min (99:30)
Beef	54°C 130°F	2 hours (02:00)	99 hrs, 30 min (99:30)
Egg	70°C 158°F	30 minutes (00:30)	24 hrs (24:00)

### Other settings

- Automatic Keep Warm is OFF by default.
- Delay Start is not available.

### What you need to sous vide

- Tongs
- Food safe, airtight, re-sealable food pouches

OR

- Vacuum sealer and food-safe vacuum bags

## How to sous vide

### Prep

1. Cut, chop, season or marinate your ingredients according to your recipe.
2. Add the ingredients to the cooking bag or pouch and seal tightly.

### Preheat

1. Place the empty inner cooking pot into the cooker base and close and lock the lid.
2. Press **Sous Vide** on the Control Panel.
3. Turn the **Control Knob** to highlight the Smart Program you want to use, then press the **Control Knob** to select it.
4. The default cooking time flashes. To select it, press the **Control Dial**. Or to change it, turn the **Control Dial** to change it, then press the dial to select it.
5. The default temperature flashes. To select it, press the **Control Dial**. Or to change it, turn the **Control Dial** to change it.
6. Press **Start**. The message display display **Preheating** and the unit starts heating.

### Cook

1. When the message display shows **Hot**, unlock and open the lid.
2. Add the sealed cooking bag or pouch to the inner cooking pot and reclose and lock the lid.
3. The cooking time starts counting down.
4. When cooking time reaches 00:00, cooking stops.

*You can press Cancel to stop cooking at any time.*

### Remove food

When cooking completes, the display shows **End**. Open the lid and use the tongs to carefully remove the cooking pouch.

## CAKE

The Cake Smart Program uses pressurized steam to bake cakes quickly and evenly, especially cheesecakes. You can adjust the settings as your recipe directs.

Program	Default Cook Time	Min Cook Time	Max Cook Time	Default Pressure Level
Custom	30 minutes (00:30)	1 minute (00:01)	4 hours (04:00)	High

### Other settings

- Automatic Keep Warm is set to ON by default.
- Delay Start is available.

### How to pressure cook

#### Prep

Prepare the ingredients according to your recipe.

#### Preheat

1. Add ingredients to the inner cooking pot and place the inner cooking pot into the cooker base.
2. Place the lid on top of the cooker base and lock the lid.
3. Press **Cake** and the Custom Smart Program flashes.
4. The default cooking time flashes. To select it, press the **Control Dial**. Or to change it, turn the **Control Dial** to change it, then press the dial to select it.
5. The default pressure level flashes. To select it, press the **Control Dial**. Or to change it, turn the **Control Dial** to change it.
6. You can delay cooking if you want. Press **Delay Start**, then turn the **Control Knob** to select the delay time.

7. Keep Warm setting is ON by default. Press **Keep Warm** to turn it off.
8. Press **Start**. The display shows **Preheating** and the Instant Pot Duo Plus is building pressure

*It can take 10-15 minutes to reach the pressure setting for cooking.*

## **Cook**

1. When the pressure is ready, the message display shows **Do Not Open Lid**. Cooking starts, and the progress bar shows **Cooking**.
2. The cooking time starts counting down.

*You can press Cancel to stop cooking at any time.*

## **Stop cooking**

1. When cooking time reaches 00:00, cooking stops.
2. If Keep Warm is ON, the time starts counting up.

## **Release steam**

Choose the steam release method that works for your recipe.

*See 'How to release steam' above for full details*



## KEEP WARM

You can choose to allow Keep Warm to turn on automatically after cooking on many Smart Programs, and you can also use Keep Warm separately to reheat food.

### Keep warm after cooking

1. When cooking is finished, automatic warming begins. The timer shows the time passed, up to 10 hours.
2. To turn automatic warming off (either during cooking or during automatic warming), press **Keep Warm** and the light above the button turns off.

### Reheat food

1. When in Standby mode, press **Keep Warm**.
2. The default cooking time flashes. To select it, press the **Control Dial**. Or to change it, turn the **Control Dial** to change it, then press the dial to select it.
3. The default temperature level flashes. To select it, press the **Control Dial**. Or to change it, turn the **Control Dial** to change it.

Program	Default Cook Time	Default Temperature	Min/Max Cook Time
Manual	10 hours (10:00)	High	30 min / 10 hrs (00:30 / 10:00)

## CLEANING

Clean your Instant Pot Duo Plus after each use. Always unplug the unit and let all parts cool to room temperature before cleaning. Before use or storing, make sure all surfaces are dry.

Part	Cleaning instructions
Accessories <ul style="list-style-type: none"><li>• Steam Rack</li><li>• Condensation Collector</li><li>• Sealing Ring</li></ul>	<ul style="list-style-type: none"><li>• Wash after each use</li><li>• Hand wash with hot water and mild dish soap or wash in dishwasher, top rack</li><li>• Never use harsh chemical detergents, powders or scouring pads on accessories</li><li>• Empty and rinse condensation collector after each use</li></ul>
Lid and Parts <ul style="list-style-type: none"><li>• Anti-Block Shield</li><li>• Sealing Ring</li><li>• Steam Release Vent</li><li>• Silicone Cap</li><li>• Steam Release Cover</li></ul>	<ul style="list-style-type: none"><li>• Hand wash with hot water and mild dish soap or wash in dishwasher, top rack</li><li>• Remove all small parts from lid before washing.</li><li>• With steam release valve and anti-block shield removed, clean interior of steam release pipe to prevent clogging.</li><li>• To drain water from the lid after dishwashing, grasp the lid handle and hold the lid vertically over a sink, then turn it all the way around</li><li>• After cleaning, store the lid upside down on the cooker base</li><li>• Store sealing rings in a well-ventilated area to disperse odor</li><li>• To eliminate odors from sealing ring, add 1 cup (8 oz / 250 mL) water and 1 cup (8 oz / 250 mL) white vinegar to inner cooking pot, and run Pressure Cook for 5-10 minutes, then use Quick Steam Release</li></ul>
Inner Cooking Pot	<ul style="list-style-type: none"><li>• Wash after each use.</li><li>• Hand wash with hot water and mild dish soap or wash in dishwasher*</li><li>• Hard water stains may need a vinegar-dampened sponge and scrubbing to remove</li><li>• For tough or burned food residue, soak in hot water for a few hours before cleaning</li><li>• Dry all exterior surfaces before placing in cooker base</li></ul>
Power cord	<ul style="list-style-type: none"><li>• Use a barely-damp cloth to wipe any particles off cord</li></ul>
Cooker base	<ul style="list-style-type: none"><li>• Wipe the inside of the cooker base as well as the condensation rim with a barely-damp cloth, and allow to air dry</li><li>• Clean the outside of the cooker base and the control panel with a soft, barely-damp cloth or sponge</li></ul>

*\*Some discoloration may occur after machine washing, but this will not affect the cooker's safety or performance.*

## TROUBLESHOOTING

Problem	Cause	Solution
Difficulty closing lid	Sealing ring not properly installed	<ul style="list-style-type: none"> <li>• Reposition sealing ring, ensure it is snug behind sealing ring rack.</li> </ul>
	Contents in cooker are still hot	<ul style="list-style-type: none"> <li>• Set Steam Release switch to Vent, then lower lid onto cooker base</li> </ul>
Difficulty opening lid	Pressure inside the cooker	<ul style="list-style-type: none"> <li>• Release pressure according to recipe; only open lid after float valve has dropped down.</li> </ul>
Inner pot is stuck to lid when cooker	Cooling of inner pot may create suction, causing inner pot to adhere to the lid	<ul style="list-style-type: none"> <li>• To release the vacuum, set Steam Release to Vent.</li> </ul>
Steam leaks from side of lid	No sealing ring in lid	<ul style="list-style-type: none"> <li>• Install sealing ring.</li> </ul>
	Sealing ring damaged or not properly installed	<ul style="list-style-type: none"> <li>• Replace sealing ring.</li> </ul>
	Food debris attached to sealing ring	<ul style="list-style-type: none"> <li>• Remove sealing ring and clean thoroughly.</li> </ul>
	Lid not closed properly	<ul style="list-style-type: none"> <li>• Open, then close lid.</li> </ul>
	Sealing ring rack is warped or off-center	<ul style="list-style-type: none"> <li>• Remove sealing ring from lid, check sealing ring rack for bends or warps. Contact Consumer Care.</li> </ul>
	Inner cooking pot rim may be misshapen	<ul style="list-style-type: none"> <li>• Check for deformation and contact Consumer Care.</li> </ul>
Minor steam leaking/ hissing from steam release vent during cooking cycle	Cooker is regulating excess pressure	<ul style="list-style-type: none"> <li>• This is normal; no action required.</li> </ul>

<b>Problem</b>	<b>Cause</b>	<b>Solution</b>
Steam gushes from steam release vent when Steam Release switch is in Seal position	Not enough liquid in the inner pot	<ul style="list-style-type: none"> <li>• Add thin, water-based liquid to the inner pot according to its size: 6 Quart: 1 1/2 cups (12 oz / 375 mL) 8 Quart: 2 cups (16 oz / 500 mL)</li> </ul>
	Pressure sensor control failure	<ul style="list-style-type: none"> <li>• Contact Consumer Care.</li> </ul>
	Internal steam release valve not seated properly	<ul style="list-style-type: none"> <li>• Check Steam Release switch to ensure it's set to Seal.</li> </ul>
Display remains blank after connecting the power cord	Bad power connection or no power	<ul style="list-style-type: none"> <li>• Inspect power cord for damage. If damage is noticed, contact Consumer Care.</li> <li>• Check outlet to ensure it is powered.</li> </ul>
	Cooker's electrical fuse has blown	<ul style="list-style-type: none"> <li>• Contact Consumer Care.</li> </ul>
Occasional clicking or light cracking sound	The sound of power switching and expanding pressure board when changing temperatures	<ul style="list-style-type: none"> <li>• This is normal; no action needed.</li> </ul>
	Bottom of the inner pot is wet	<ul style="list-style-type: none"> <li>• Wipe exterior surfaces of inner pot. Ensure heating element is dry before inserting inner pot into cooker base.</li> </ul>
Error code appears on display and cooker beeps continuously	There is an issue with the cooker	<ul style="list-style-type: none"> <li>• Read "Error Codes" for instructions.</li> </ul>

## ERROR CODES

If the control panel displays an error code from this list, there is an issue with the Duo Plus. Here are the actions you should take to fix the problem.

Problem	Cause	Solution
C1 C2 C6 C6H C6L	Faulty sensor	<ul style="list-style-type: none"><li>• Contact Consumer Care.</li></ul>
C5	Temperature is too high because inner pot is not placed in the cooker base	<ul style="list-style-type: none"><li>• Press Cancel and wait for heating element to cool; ensure there are no foreign objects in cooker base; insert or reposition inner pot in cooker base and re-enter commands.</li></ul>
C5	Temperature is too high because there is no water in inner pot	<ul style="list-style-type: none"><li>• Check for scorching on bottom of inner pot. Add thin, water-based liquid to the inner pot according to its size:</li><li>• 3 Quart: 1 cup (8 oz / 250 mL)</li><li>• 6 Quart: 1 1/2 cups (12 oz / 375 mL)</li><li>• 8 Quart: 2 cups (16 oz / 500 mL)</li></ul>
C7 or NoPr	Heat element has failed	<ul style="list-style-type: none"><li>• Contact Consumer Care.</li></ul>
C7 or NoPr	Not enough liquid	<ul style="list-style-type: none"><li>• Add thin, water-based liquid to the inner pot according to its size:</li><li>• 3 Quart: 1 cup (8 oz / 250 mL)</li><li>• 6 Quart: 1 1/2 cups (12 oz / 375 mL)</li><li>• 8 Quart: 2 cups (16 oz / 500 mL)</li></ul>
C7 or NoPr	Quick release button is in the Vent position	<ul style="list-style-type: none"><li>• Check Steam Release switch to ensure it's set to Seal.</li></ul>
Lid	Lid is not in the correct position for the selected program	<ul style="list-style-type: none"><li>• Open and close the lid. Do not use a lid when using Sauté.</li></ul>

<b>Problem</b>	<b>Cause</b>	<b>Solution</b>
Food burn	High temperature detected at bottom of inner pot; cooker automatically reduces temperature to avoid overheating	<ul style="list-style-type: none"> <li>• Starch deposits at the bottom of the inner pot may have blocked heat dissipation.</li> <li>• Turn the cooker off, release pressure according to the recipe, and inspect the bottom of the inner pot.</li> </ul>
PrSE	Pressure has accumulated during a non-pressure cooking program	<ul style="list-style-type: none"> <li>• Set Steam Release switch to Vent.</li> </ul>

## LEARN MORE

There's a whole world of Instant Pot information and help just waiting for you. Here are some of the most helpful resources.

### Register your product

[instanhome.com/register](https://instanhome.com/register)

### Contact Consumer Care

In the Instant Brand Connect app  
[instanhome.com/customer-care-center](https://instanhome.com/customer-care-center)  
[support@instanhome.com](mailto:support@instanhome.com)

### Instant Brands Connect App with 1000+ recipes

[instanhome.com](https://instanhome.com)  
iOS and Android app stores

### Cooking charts and more recipes

[instanhome.com](https://instanhome.com)

### How-to videos, tips and more

[instanhome.com](https://instanhome.com)

### Replacement parts and accessories

[instanhome.com](https://instanhome.com)

### Join the community



## Product specifications

Model	Volume	Wattage	Power	Weight	Dimensions
Duo Plus 60 v4	6 Quarts 5.7 Litres	1000 W	120V/ 60Hz	12.3 lb 5.58 kg	in: 13.43 L x 13.35 W x 12.76 H cm: 34.1 L x 34 W x 32.4 H
Duo Plus 80 v4	8 Quarts 7.6 Litres	1200 W	120V/ 60Hz	15.90 lb 7.21 kg	in: 14.53 L x 14.53 W x 13.98 H cm: 37 L x 37 W x 35.5 H

# WARRANTY

## One (1) Year Limited Warranty

This One (1) Year Limited Warranty applies to purchases made from authorized retailers of Instant Brands LLC ("Instant Brands") by the original appliance owner and is not transferable. Proof of original purchase date and, if requested by Instant Brands, return of your appliance, is required to obtain service under this Limited Warranty. Provided the appliance was used in accordance with the use & care instructions, Instant Brands will, in its sole and exclusive discretion, either: (i) repair defects in materials or workmanship; or (ii) replace the appliance. In the event that your appliance is replaced, the Limited Warranty on the replacement appliance will expire twelve (12) months from the date of receipt. Failure to register your product will not reduce your warranty rights. The liability of Instant Brands, if any, for any allegedly defective appliance or part will not exceed the purchase price of a comparable replacement appliance.

## What is not covered by this warranty?

- Products purchased, used, or operated outside of the United States and Canada.
- Products that have been modified or attempted to be modified.
- Damage resulting from accident, alteration, misuse, abuse, neglect, unreasonable use, use contrary to the operating instructions, normal wear and tear, commercial use, improper assembly, disassembly, failure to provide reasonable and necessary maintenance, fire, flood, acts of God, or repair by anyone unless directed by an Instant Brands representative.
- Use of unauthorized parts and accessories.
- Incidental and consequential damages.
- The cost of repair or replacement under these excluded circumstances.

EXCEPT AS EXPRESSLY PROVIDED HEREIN AND TO THE EXTENT PERMITTED BY APPLICABLE LAW, INSTANT BRANDS MAKES NO WARRANTIES, CONDITIONS OR REPRESENTATIONS, EXPRESS OR IMPLIED, BY STATUTE, USAGE, CUSTOM OF TRADE OR OTHERWISE WITH RESPECT TO THE APPLIANCES OR PARTS COVERED BY THIS WARRANTY, INCLUDING BUT NOT LIMITED TO, WARRANTIES, CONDITIONS, OR REPRESENTATIONS OF WORKMANSHIP, MERCHANTABILITY, MERCHANTABLE QUALITY, FITNESS FOR A PARTICULAR PURPOSE OR DURABILITY.



Some states or provinces do not allow for: (1) the exclusion of implied warranties of merchantability or fitness; (2) limitations on how long an implied warranty lasts; and/or (3) the exclusion or limitation of incidental or consequential damages; so these limitations may not apply to you. In these states and provinces, you have only the implied warranties that are expressly required to be provided in accordance with applicable law. The limitations of warranties, liability, and remedies apply to the maximum extent permitted by law. This limited warranty gives you specific legal rights, and you may also have other rights which vary from state to state or province to province.

## Product Registration

Please visit [www.instanthome.com/register](http://www.instanthome.com/register) to register your new Instant Brands appliance. Failure to register your product will not diminish your warranty rights. You will be asked to provide the store name, date of purchase, model number (found on the back of your appliance) and serial number (found on the bottom of your appliance) along with your name and email address. The registration will enable us to keep you up to date with product developments, recipes and contact you in the unlikely event of a product safety notification. By registering, you acknowledge that you have read and understand the instructions for use, and warnings set forth in the accompanying instructions.

## Warranty Service

To obtain warranty service, please contact our Consumer Care Department by email to [support@instanthome.com](mailto:support@instanthome.com). You can also create a support ticket online at [www.instanthome.com](http://www.instanthome.com). If we are unable to resolve the problem, you may be asked to send your appliance to the Service Department for quality inspection. Instant Brands is not responsible for shipping costs related to warranty service. When returning your appliance, please include your name, mailing address, email address, phone number, and proof of the original purchase date as well as a description of the problem you are encountering with the appliance.





Distributed by Instant Brands LLC  
3025 Highland Parkway, Suite 700  
Downers Grove, IL 60515 U.S.

**instanthome.com**

© 2022 Instant Brands LLC  
112-0169-01

Art release date  
11/15/2022

INSTANT, INSTANT POT  
and DUO  
are registered trademarks of  
Instant Brands Holdings Inc.