



LIGHTING

Assembly Instruction

CAUTION: Read instruction carefully and turn electricity off at main circuit breaker panel before beginning installation.

ITEM#:LIT4520A

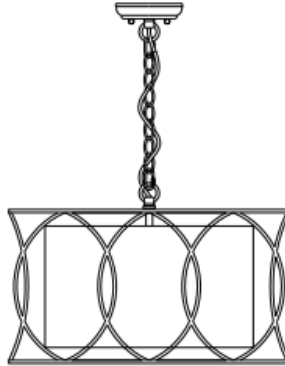

Care and Cleaning







To clean the outside of the fixture, use a dry or slightly dampened clean cloth(use clean water, never a solvent)to wipe the surface of the fixture.

To clear the inside of the fixture, first disconnect power to the fixture by turning off the circuit breaker or by removing the fuse at the fuse box. Next, use a dry or slightly dampened clean cloth(use clean water, never a solvent) to wipe the interior surface of the fixture

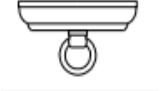
Do not use any cleaners with chemical, solvents or harsh abrasives. Use Only a dry soft cloth to dust or wipe carefully.

Estimated Assembly Time:30 minutes

Part List and Hardware List

PIECE	DESCRIPTION	PICTURE	QUANTITY	PIECE	DESCRIPTION	PICTURE	QUANTITY
A	Bulb		1X	E	Canopy		1X
B	Lamp Body		1X	F	Mounting Plate		1X
C	Pendant Chain		1X	G	Wire Nut		3X
D	Canopy Nut		2X	H	Mounting Screw		2X

Installation

Step 1

Unpack all parts from cartons carefully.
Using Wire nut(G) to connect wires

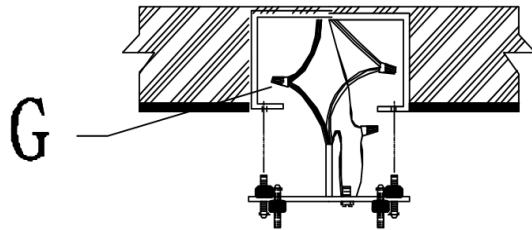

Step 2 Wire connection

Connect, Hot, Black or Red outlet Supply Wire to:	Connect, Neutral, White Outlet Supply Wire to:
Black	White
*Parallel Cord(round&smooth)	*Parallel Cord(square&ridged)
Clear, Brown, Gold or Black without Tracer(colored stripes)	Clear, Brwn, Gold or Black without Tracer(colored stripes)
Insulated Wire(not green)with copper metal conductor	Insulated Wire(not green)with Silver metal conductor

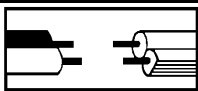

*Note: When parallel wire(SPTI&SPTII)is used. The neutral wire is square shaped and ridged and the hot wire will be round in shape and smooth.(See illustration on left)

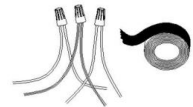

Grounding Instructions:

- For installation in the United States: Wrap ground wire from outlet box around green ground screw (F) on mounting bracket, no less than 2" from wire end. Tighten ground screw. If fixture is supplied with a ground wire, connect to outlet ground wire with a wire connector.
- For installation in Canada: If fixture is supplied with ground wire, wrap ground wire around green grounding screw on mounting bracket. Tighten ground screw.

Step 3

Fix the Mounting Plate(F) to the junction box with Mounting Screw (H).

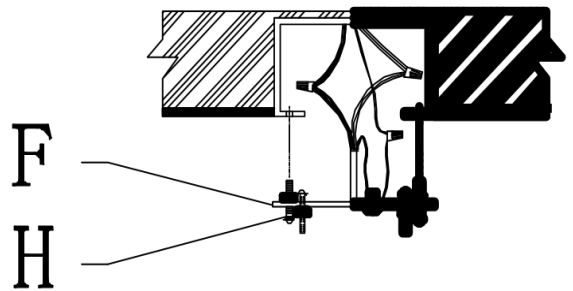

Step 4

Attach the Canopy(E) to the Mounting Plate (F) and fix it by turning the Canopy Nut (D) clockwise.

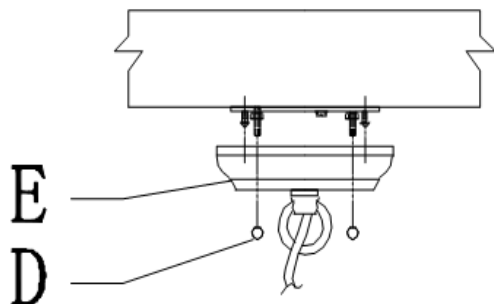

Step 5

Attach the Closable Link(C) onto the Hanging Loop at the bottom of Conapy(E)

Attach the Closable Link(C) onto the Hanging Loop at the top of lamp body(B)

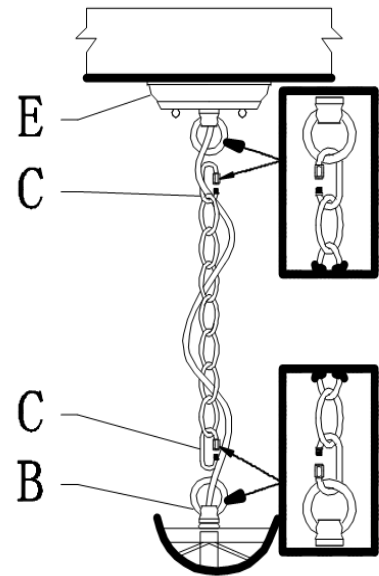

Step 6

Install bulbs (A). Be sure to use bulb with wattage no greater than specified on this fixture

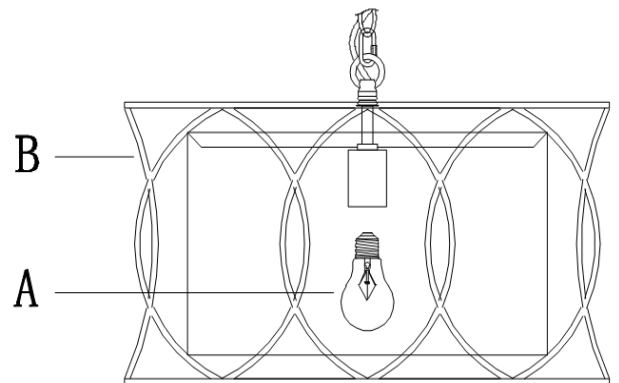

**PLEASE USE ON/OFF TYPE "A" BULB MAX
100-WATT OR CFL BULB MAX 23-WATT
THERE IS 13-WATT CFL BULB IN THE BOX**

Step 7

Consult a qualified electrician to ensure correct branch circuit conductor

ENJOY YOUR LAMP