

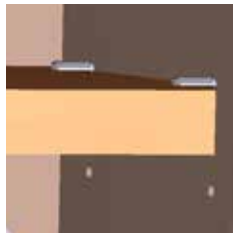

MURPHY DOOR
HIDDEN DOOR SOLUTIONS

PRE-HUNG FLUSH MOUNT INSTALLATION

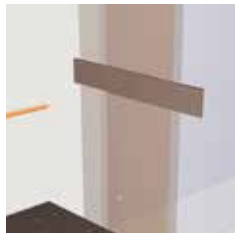

BILT.**STEP-BY-STEP 3D Interactive Instructions**available on-line - download the **FREE BILT** app today!Scan the QR code to download the app.
(available for most iOS and Android devices)

After download scan second QR code.



SCAN FOR BILT 3D INSTRUCTIONS



POWERED BY BILT INTELLIGENT INSTRUCTIONS

SHELVES

Adjustable Shelf



Adjustable Shelf



Adjustable Shelf

CASING

Casing Top

Casing Side

Casing Side



To complete this procedure, you will need:

- Tape Measurer
- Drill
- Counter Sink Bit
- 1/8" Drill Bit
- Hammer
- Level
- Wood Glue

Q

Hinge Pin Removal Tool

F

(8) 3" Screws

P

(12) Shelf Pins

3 Year Warranty (U.S.A. only)

Murphy Door warrants your door against defects in material and workmanship under normal use and maintenance for a period of three (3) years from the date of original purchase.

Murphy Door Inc. will provide a replacement part for any part found to be defective. Original part(s) approved for return by Murphy Doors customer service department must be returned prepaid. This warranty does not include labor charges connected with the determination or replacement of defective parts, or freight charges to ship these parts.

Murphy Door Inc. shall not be liable under this or any implied warranty for incidental or consequential damages. This warranty gives the retail customer specific legal rights and the customer may have other rights which vary from state to state.

This warranty shall be void if the unit is not assembled or operated in accordance with the operation instructions provided with this unit; the unit is re-sold or traded to another owner; components, accessories; or the user has abused or otherwise failed to maintain the unit.

To process a warranty claim, Murphy Door requires you to register your product on our BILT app and proof of your date of purchase. You should retain your sales slip or invoice with your valuable documents.

**1**

Locate the hinge in the upper corner of the door. Place the hinge pin removal tool (Q) on the hinge pin to retract and remove the pin as shown.

**2**

Remove the door from the jamb by lifting it up and off the bottom pivot hinge.

PLEASE READ INSTRUCTIONS FULLY BEFORE YOU BEGIN INSTALLATION

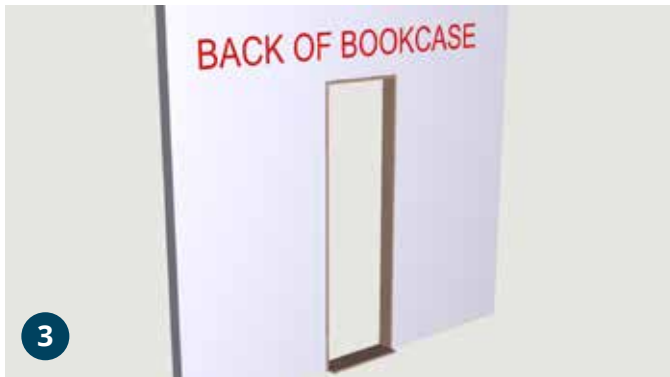

Place the door jamb into the rough opening. The bottom jamb threshold should extend into the room toward the back of the bookcase.



It is critical that the bottom threshold and jamb sides are level. If the door jamb is not level and plumb the door will not swing and close properly.

Note: The bottom threshold **SHOULD NOT** be installed over carpeting. Carpet will effect levelling and prevents proper function of the door.

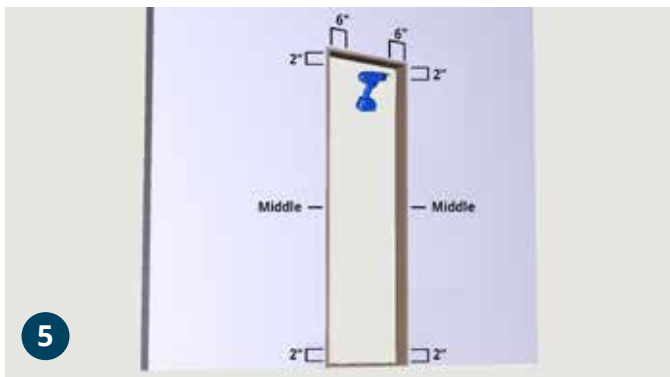

Using the 1/8" drill bit, pre-drill and countersink two holes into the jamb top, 6" from the right and left side of the jamb. Then pre-drill and countersink three holes into each side of the door jamb, 2" from the top of the jamb, 2" from the bottom of the jamb, and in the middle.

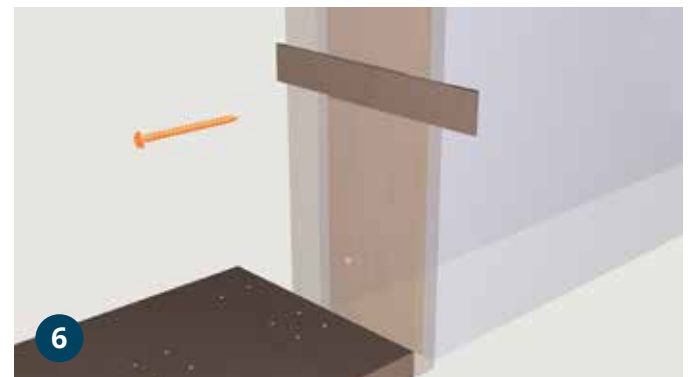

Using shims where needed, install (8) 3" screws (F) making certain the top and sides of jamb are level.

Note: The screws included are meant for a wood frame. If installing the jamb into a steel frame, replace the screws with (8) 3" self-tapping screws.

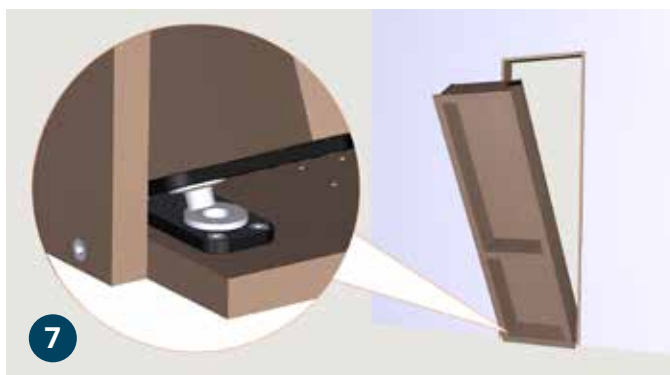

Place the door into the door jamb, making sure that the bottom pivot hinge sits in the silver thrust bearing.

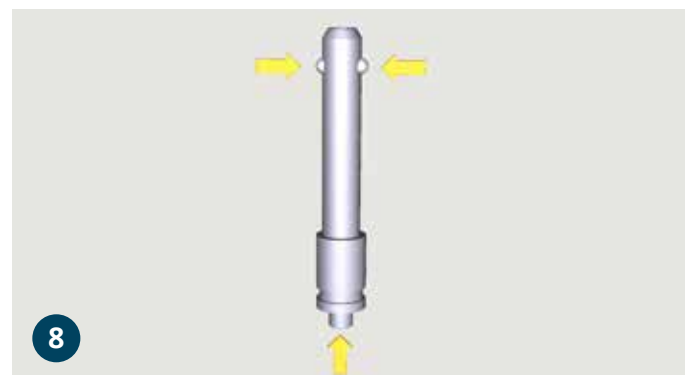

Press down on the ball lock of the hinge pin to retract the two top pins.

PLEASE READ INSTRUCTIONS FULLY BEFORE YOU BEGIN INSTALLATION



9
Insert the hinge pin into the top hinge holes making certain the pin locks into place. On an out-swing door the pin will appear countersunk when properly locked.

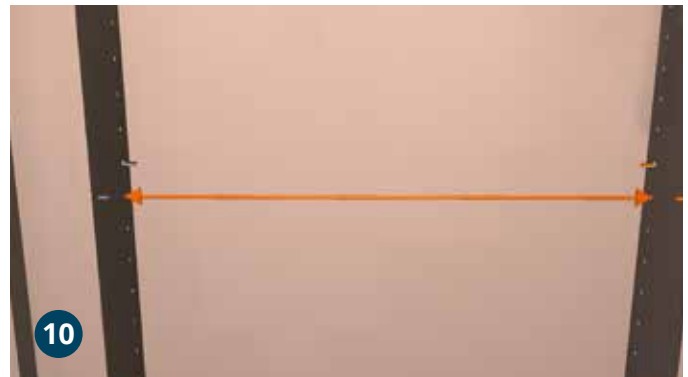

10
Add (4) shelf pins (P), 2 on each side of the bookcase at equal heights.

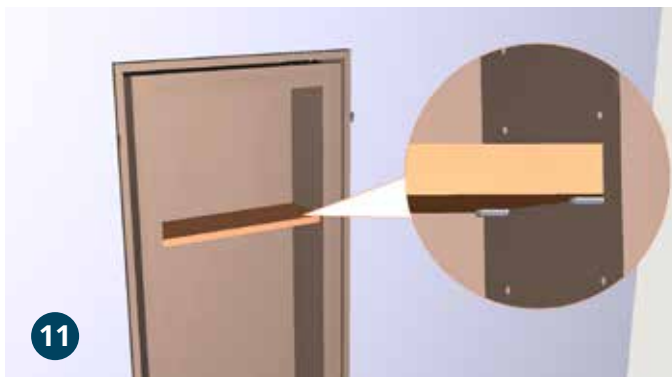

11
Slide the shelf into place onto the installed shelf pins. Do the same for the remaining shelves.

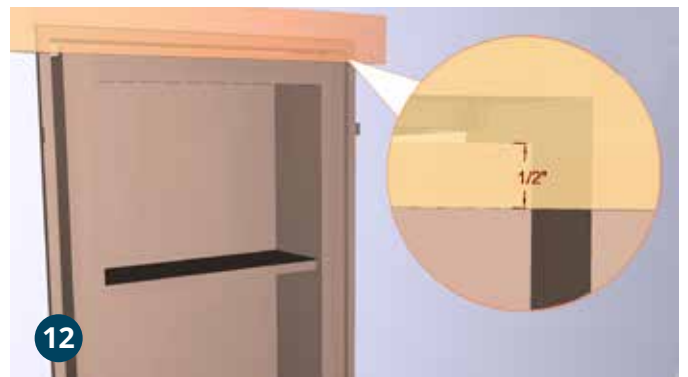

12
For an in-swing door position the top casing with a 1/2" overhang on the face frame of your door. Attach using a hammer and finishing nails.

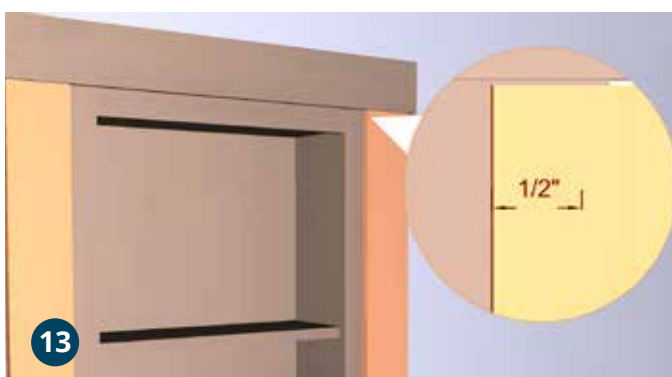

13
Position the right and left side casings with a 1/2" overhang on the face frame of the door. Attach using a hammer and finishing nails.



14
Test the in-swing to ensure the door opens and closes smoothly.

PLEASE READ INSTRUCTIONS FULLY BEFORE YOU BEGIN INSTALLATION



For an out-swing door, attach the casing onto the door jamb with a 1/2" overhang on the door face frame. Make sure the top of the casing has at least a 1/16" clearance over the door itself.



Using a 1/8" drill bit, pre-drill three holes into your left support face frame. This will make it easier to attach the left side casing.



Run a bead of glue down the face frame of the door prior to securing with screw to strengthen the left casing.



Now with the face frame pre-drilled, attach the left side casing. Before you screw in trim, swing the door with the trim to insure it doesn't drag on the floor.

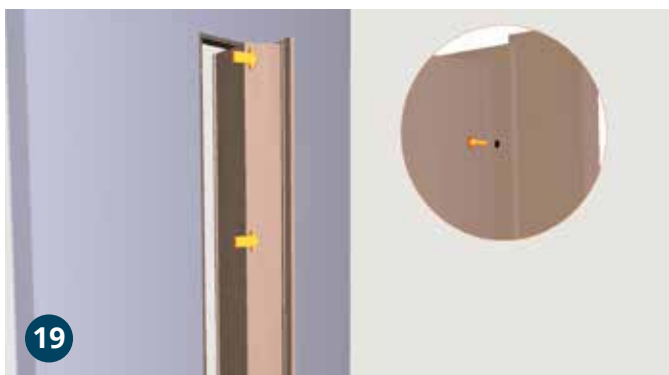

With the casing attached screw in 1-1/4" screws, making sure not to drill through other side of front casing.



Center and attach the top casing using a hammer and finishing nails.

Congratulations.

This concludes the Murphy Door Flush Mount installation procedure.

PLEASE READ INSTRUCTIONS FULLY BEFORE YOU BEGIN ASSEMBLY

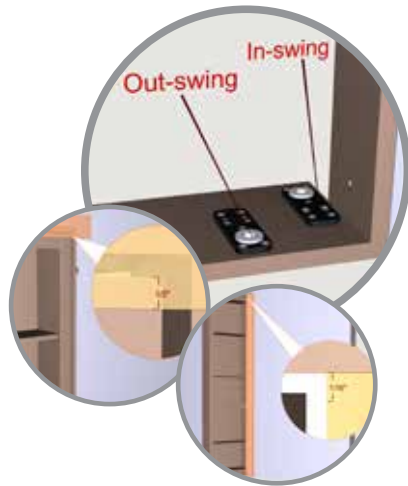

BEFORE YOU START

- If you are not installing door on receipt keep it standing level on its base or lay it flat. **DO NOT** lean it against a wall on its edge.
- Proper moving (**MURPHY DOOR IS NOT RESPONSIBLE FOR DROPPED DOOR DAMAGE**)
 - Take door/cabinet out of jamb and carry cabinet and jamb separately.
 - **DO NOT** carry or lift by face frame.
 - The doors are heavy, handle with care.
 - Support the entire door when carrying and lifting the door.
 - Minimum of two persons recommended.
- Make sure all instructions are read and understood by installer prior to installing your door. Our doors are unique and have particular finishing details.
 - The cabinet is 1-1/2" to 2" narrower than the jamb. This allows for proper function of the door. Gaps will be covered by finish casing.
 - In-swing and out-swing casing and hinges are placed differently.
 - There will be some wall finishing needed were the wall meets the jamb. For best results prep the wall with the sheet rock edge cut as straight and clean as possible.
- Verify that you have all parts prior to starting the installation or hiring a contractor.
- Test your pin to make sure it works properly.
 - Hold the pin while pushing the center button. The two ball bearings should retract slightly. If the ball bearings do not retract spray with dry lube. Engage the center button several times. Recheck to see if pin is working properly. **DO NOT USE IF PIN ISN'T WORKING PROPERLY.**

UNINSTALLING DOORS

Out-Swing Door

- Take pressure off the door. The pin must be vertical and the holes of the hinges must be aligned. If there is too much friction, the pin will not easily slip out of the hinges.
- Locate hinge pin in the top of the cabinet through a 1" hole.
- Put the hinge pin removal tool up around the pin.
- Carefully pull the pin down as you slightly wiggle the removal tool.
- Once top pin is out, you can lift the door off the bottom hinge.

In-Swing Door

- Take pressure off the door.
- Pin will be mounted to the side of the door.
- Push the button on the pin, while pulling the pin down as you wiggle it down and out.
- Once top pin is out, you can lift the door off the bottom hinge.

If you lose the pin removal tool, you can order another at **MurphyDoor.com**. Taping the pin removal tool to the fixed shelf can be a simple solution.



PLEASE READ INSTRUCTIONS FULLY BEFORE YOU BEGIN ASSEMBLY



INSTALLATION TIPS

• Framing

- Rough opening should be framed with 2"x 4" studs.
- 2"x 6" studs can only be used with out-swing doors.
- If using metal studs, replace the included 2-1/2" screws with (8) 2-1/2" self-tapping screws.
- Make sure your studs are parallel (measure top, middle and bottom of the jamb RO) and square (by putting a square in all four corners). If they are not, your Murphy Door will not function properly and may appear bowed.

• Threshold

- For best results install the door on a level surface. **DO NOT** install the bottom threshold over carpeting. Carpet will effect levelling and prevents proper function of the door.
- If you must shim the threshold, it is best to have a shim that is the width of the threshold and runs the entire length of space needed to shim.



• Jamb

- **DO NOT** over or under tighten jamb. When installing the jamb, you need to make sure it is shimmed properly. It should be level and square with the threshold and header. If the jamb is not square it may cause your door to function improperly or appear to sag.

• Hinge Pin Installation

- On out-swing doors make sure the pin goes up through the hole in the top of the door and through both hinges. **DO NOT** put the pin in from the top down. If properly installed the pin should countersink or be flush with the top of the cabinet. If it protrudes below the header it is not properly seated and may fail causing the door to fall out.

BE CERTAIN that the hinge pin is seated and goes through both hinges.

Out-Swing Door



• Out-Swing Door

- For the best results cut the sheet rock edge as straight and clean as possible on the non-hinge installation side; left edge for a right out-swing, right edge for a left out-swing. Install the jamb tight to prepped edge. Shim the hinge edge as needed. This will make for less finish work.

• Casing (aka Trim)

- Make sure your door opens, closes, and swings properly prior to installing the casing.
- Attach vertical casing, first then top casing. This will make it easier to visually center the top casing.
- The MD casing is designed so the top casing goes past the side casings 1-1/2" per side.

• Finishing

- Make sure your door works properly before you finish the wall.
- Caulk, mud, or tape to finish the edge where the wall meets the jamb.

PLEASE READ INSTRUCTIONS FULLY BEFORE YOU BEGIN ASSEMBLY



Move lower jamb out half pop distance.



TROUBLESHOOTING

My out-swing door protrudes at the top or swings open on its own?

- Move the jamb on lower hinge side out 1/2 the pop distance. If the pop out is 1/2", moving the jamb 1/4" out will fix 99% of all issues. Home construction is seldom square and plumb and may sometimes make our doors appear not to be.
- Ensure that the wall, door and casing are level.
- Make sure that corners in jamb are square.
- Make certain that the hinges are plumb, aligned top and bottom.
- Lay door on flat surface and use straight edge to make sure that the door is not bowed, swelled or over sanded. Using the longest straight edge possible, 4'-6', to get the most accurate results. The straight edge must be a manufactured level, square or similar tool.
- Check casing and door to see if one is bowed.

My door sags on the non-hinge side?

- Make sure floor is level.
- Check door to make sure wood is level and unbowed.
- Check jamb to make sure it square and level, not over or under tightened.
- Check friction catch measurements.

My hinge pin will not go in the hinge?

- Sand the hole - paint over spray may be hindering seating.
- Take pressure off the door.
- Spray with dry lube. Ball bearings failing to retract may prevent seating.
- If the pin will not go in, **DO NOT** use a tool to tap it in. This will damage the pin and make it harder to get out.
- If the above steps have been taken and you still cannot get the pin in, check your jamb and door to be sure they are plumb and level.

PAINTING & STAINING

- If you are finishing your door with paint or stain, we encourage you to do so within 10 days to seal the wood. This will help minimize climate differences. Murphy Door can not offer a warranty against sagging or warping on unfinished doors.
- Use care when applying. Keep pre-drilled holes free of excess paint or stain to make assembly easier.
- DO NOT use water-based paints. Commercial grade furniture paints and stains are required.
- Always do a sample test with your paint or stain. The sides of the jamb that will be placed against the wall are great places to test, as they will not be seen once the door is installed.
- Always read and follow the paint or stain instructions before applying to the door.