

LOWELL / CALINDA / RIDLEY

BENTWOOD DINING CHAIR

MODEL # AXCLOW-G

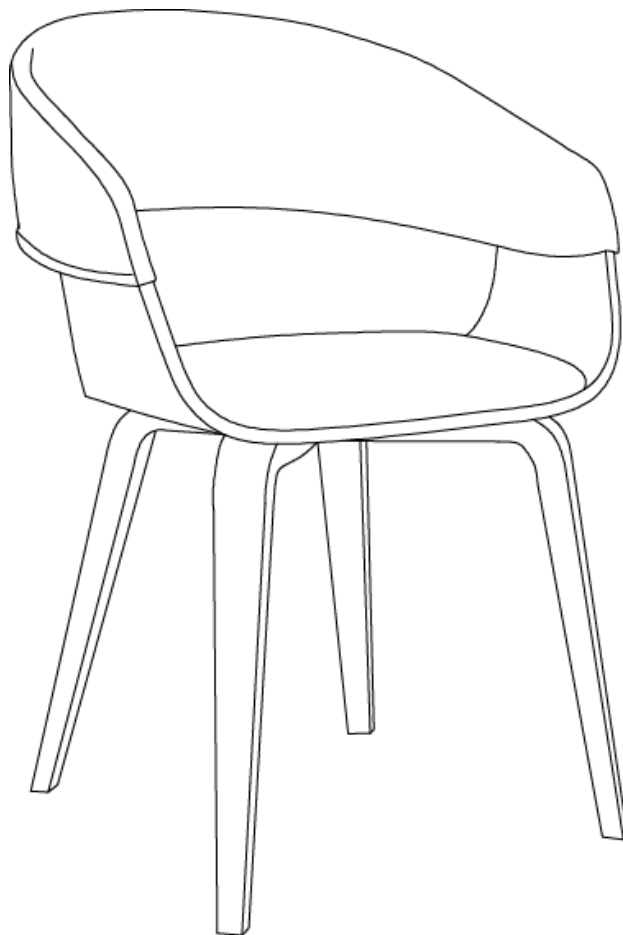



**FOR REPLACEMENT PARTS OR HELP WITH
ASSEMBLY PLEASE CONTACT US AT:**

simpli-home.com/customer-support

**PLEASE ENSURE TO HAVE THE MODEL #
FROM THE PACKAGING OR INSTRUCTION BOOKLET**

**TO RETURN THE PRODUCT:
PLEASE CONTACT THE RETAILER
WHERE THE ITEM WAS PURCHASED FROM**



**ENTER
TO WIN**

**Upload an image of our furniture
in your home with a short review
to our facebook page for a chance to**

**Win up to \$3000 of
Simpli Home furniture!!!**

www.facebook.com/simplihomefurnishings



IMPORTANT: Please read this manual carefully before beginning assembly of this product. Keep this manual for future reference.

SAFETY INFORMATION

Identify all the parts and hardware. Do not discard of the packaging until you have checked that you have all of the parts and hardware required. Hardware package may have spare parts.

WARNING: This item contains small parts which can be swallowed by children and pets. Keep children and pets away during assembly. To avoid danger of suffocation, always keep plastic bags away from children and pets.

We recommend that you assemble this unit on a carpeted floor to avoid scratches. We do not recommend the use of power tools for assembly as this could damage the unit. Only use manual tools.

Requires 2 people for ease of assembly.

CARE and MAINTENANCE

Wipe regularly with clean water and a damp, clean, soft white cloth.

General cleaning can be done as needed with a mild detergent and water solution. Always rinse with clean water and dry.

For heavy soiling, dampen a soft white cloth or soft bristle brush. Use care as scrubbing can damage the surface.

More difficult stains can be treated, but this should be occasional, not daily, cleaning. ANY cleaning solution used must be removed with clean water and a clean white cloth. Cleaning residue left on the material can cause it to dry out and crack, or affect the color.

DO NOT use any cleaners with corrosive ingredients (lye, acids or ammonia).

PRE-ASSEMBLY INFORMATION

PARTS DESCRIPTION

1

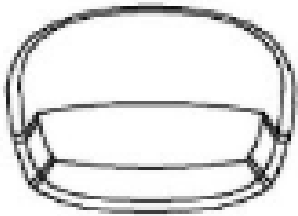

CHAIR
QTY 1

2

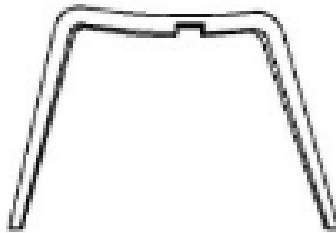

LEG
QTY 1

3



LEG
QTY 1

NEED HELP? For help with assembly or if you are missing a part,
Please call customer service at 1-866-518-0120 ext. 262 (9 am to 4 pm EST)

PRE-ASSEMBLY INFORMATION

HARDWARE DESCRIPTION

A



ALLEN KEY SCREW
M6 X 30 mm
QTY 1

B



ALLEN KEY SCREW
M6 X 42 mm
QTY 4

C



ALLEN KEY
QTY 1

D

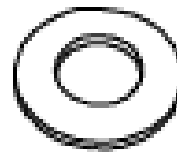

WASHER
QTY 5

NEED HELP? For help with assembly or if you are missing a part,
Please call customer service at 1-866-518-0120 ext. 262 (9 am to 4 pm EST)

ASSEMBLY

STEP 1

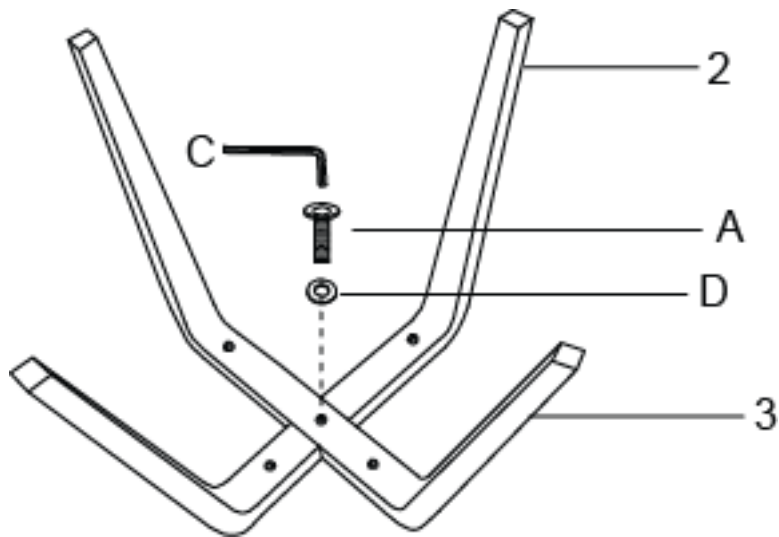

Attach Leg (3) to Leg (2) with Allen Key Screw (A) and Washer (D).
Use Allen Key (C) to tighten.

ASSEMBLY

STEP 2

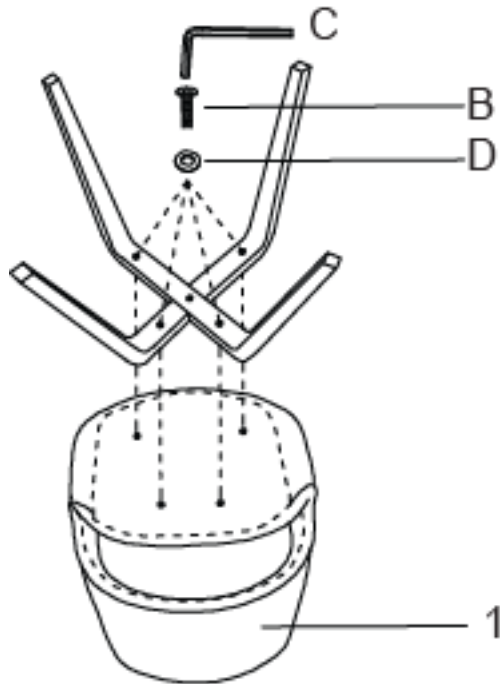

Attach the Legs to the Seat (1) with Allen Key Screws (B) and Washers (D).

Use the Allen Key (C) to tighten.

ASSEMBLY

STEP 3

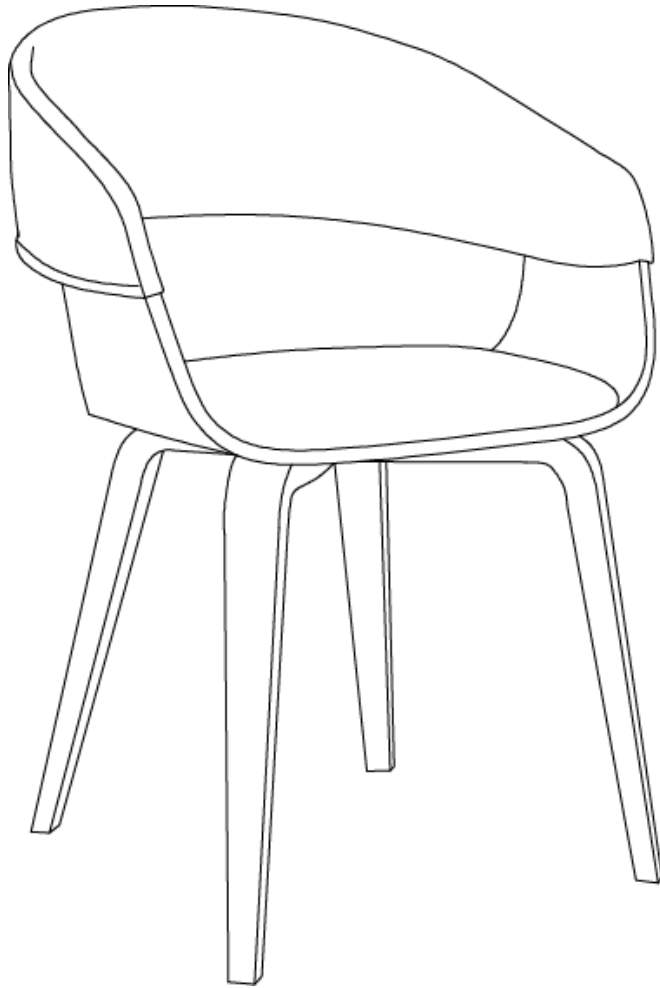

Turn Chair right side up.



WARRANTY

Thank you for purchasing a **Simpli Home – Wyndenhall – Brooklyn + Max** product. These products have been made to demanding, high-quality standards and are guaranteed for domestic use against manufacturing faults for a period of 12 months from the date of purchase. This warranty does not affect your statutory rights.

In case of any malfunction of your product (failure, missing parts, etc.) please contact us at our toll free service line at 1-866-518-0120 ext. 262 from 9 am to 4 pm, Monday to Friday, Eastern Standard Time or by email at customerservice@simpli-home.com.

We reserve the right to repair or replace the defective product, at its discretion.

This product is guaranteed for 12 months if used for normal purposes. Any warranty is invalid if the product has been overloaded or subject to neglect, improper use or an attempted repair by other than an authorized agent. Heavy-duty or daily professional/commercial usage are not guaranteed.

Due to continuous product improvement, we reserve the right to change the product specifications without prior notice.



Question, problems, missing parts?

Before returning your product

please email Customer Support at

customerservice@simpli-home.com

or call

Customer Service at 1-866-518-0120 ext. 262

Monday to Friday between 9 am – 4 pm EST

For more information visit us on our website

www.simpli-home.com

Like us on facebook

www.facebook.com/simplihomefurnishings