

USE AND CARE GUIDE

5 LIGHT LED PUCK LIGHT KIT (WHITE AND BLACK FINISH)

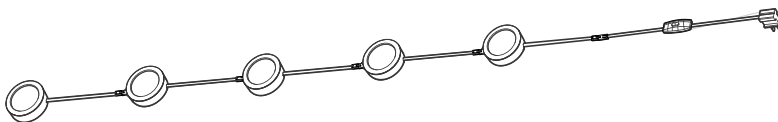

Questions, problems, missing parts? Before returning to the store,
call Commercial Electric Customer Service
8 a.m. – 7 p.m., EST, Monday - Friday, 9 a.m. - 6 p.m., EST, Saturday

1-877-527-0313

HOMEDEPOT.COM

THANK YOU

We appreciate the trust and confidence you have placed in Commercial Electric through the purchase of this LED puck light kit. We strive to continually create quality products designed to enhance your home. Visit us online to see our full line of products available for your home improvement needs. Thank you for choosing Commercial Electric!

Table of Contents

Table of Contents2
 Safety Information2
 Warranty3
 Planning Installation3
 Tools Required3
 Hardware Included3
 Package Contents4

Installation - Surface Mounting 5
 Installation - Recessed Mounting 7
 Direct Wire Installation (optional) 8
 Installing the quick connector plug (optional) 8

Safety Information

1. Read all instructions carefully before you begin this installation.
2. This equipment has been tested and found to comply with the limits for a Class B digital device pursuant to Part 15 of the FCC Rules and ICES-005 of the IC Rules. These limits are designed to provide reasonable installation protection. This equipment generates and can radiate radio frequency energy and, if not installed and used in accordance with the instructions, may cause harmful interference.
3. There is no guarantee that interference will not occur in a particular installation, if this equipment does cause harmful interference to radio and television reception, which can be determined by turning the equipment off and on, the user is encouraged to try to correct the interference by one or more of the following measures: a) Reorient or relocate the receiving antenna, b) Increase the separation between the equipment and the receiver, c) Connect the equipment into a different outlet and circuit from the receiver outlet and circuit, d) Consult the dealer or an experienced radio/TV technician for help.
4. Change or modification to this unit not expressly approved by the party responsible for compliance could void the user's authority to operate the equipment.
5. Rated at 120V/60Hz, 3.43W x 5, Max 3.43W x 30.
6. Linkable, add up to 30 units.
7. The product is dimmable and can be used with a dimmer switch. See compatible dimmer list this manual.
8. Suitable for recess mounting only inside a cabinet.
9. Suitable for surface mounting only inside a cabinet.
10. Compatible with Direct Wire Junction Box (SKU1006126385), sold separately.

 **WARNING:** Deviation from the assembly instructions may result in a risk of fire or electric shock.

 **CAUTION:** The National Electrical Code (NEC) does not permit cords to be concealed where damage to insulation may go unnoticed. To prevent fire danger, do not run the cord behind walls, ceilings, soffits, or cabinets where it may be inaccessible for examination. Cords should be visually examined periodically and immediately replaced when any damage is noted.

 **CAUTION:** For indoor and dry location use only.

 **CAUTION:** To reduce the risk of fire, electric shock, or injury to persons use only insulated staples or plastic ties to secure cords. Route and secure cords so that they will not be pinched or damaged when the cabinet is pushed to the wall.

 **CAUTION:** Do not operate the fixture with a missing or damaged cover or housing.

 **CAUTION:** To prevent the risk of fire, do not install each puck LED lamp in a compartment smaller than 12 in. x 12 in. x 12 in.

 **CAUTION:** Not intended for recessed installation in ceilings, or soffits.

 **CAUTION:** The LED source cannot be replaced.

 **CAUTION:** Do not mount this fixture near heat sources which may damage this fixture.

 **CAUTION:** Do not stare directly into the LED source.

 **CAUTION:** Do not dismantle or alter this fixture.

Warranty

LIMITED WARRANTY

The manufacturer warrants this product to be free from defects in materials and workmanship for a period of five (5) years from date of purchase. This warranty applies only to the original consumer purchaser and only to products used in normal use and service. If this product is found to be defective, the manufacturer's only obligation, and your exclusive remedy, is the repair or replacement of the product at the manufacturer's discretion, provided that the product has not been damaged through misuse, abuse, accident, modifications, alterations, neglect or mishandling. This warranty shall not apply to any product that is found to have been improperly installed, set-up, or used in any way not in accordance with the instructions supplied with the product. This warranty shall not apply to a failure of the product as a result of an accident, misuse, abuse, negligence, alteration, or faulty installation, or any other failure not relating to faulty material workmanship. The manufacturer specifically disclaims any liability and shall not be liable for any consequential or incidental loss or damage, including labor/expense costs involved in the replacement or repair of said product.

Contact the Customer Service Team at 1-877-527-0313 or visit HOMEDEPOT.COM.

Pre-installation

PLANNING INSTALLATION

Read all instructions completely before you begin installation.

TOOLS REQUIRED



Phillips
screwdriver



Drill

HARDWARE INCLUDED



NOTE: Hardware not shown to actual size.



____ AA



____ BB

Part	Description	Quantity
AA	Mounting screw	14
BB	Fastener	20

Pre-installation (continued)

PACKAGE CONTENTS

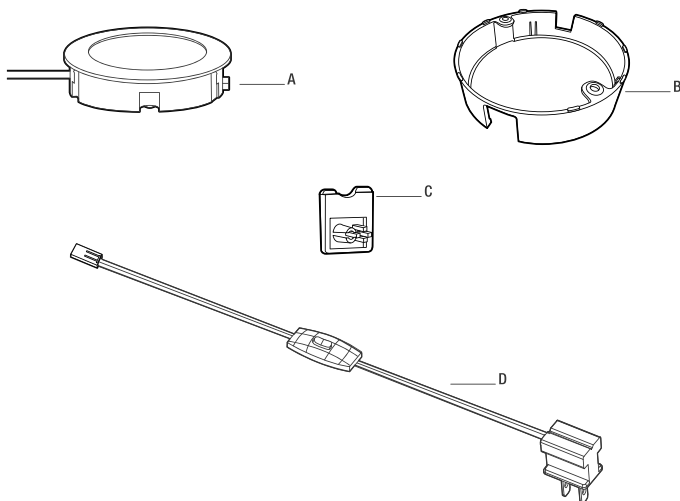

Part	Description	Quantity
A	LED puck assembly	5
B	Trim ring (preassembled to LED lights A)	5
C	End cap (preassembled to LED lights A)	5
D	Power cord	1

DIMMER COMPATIBILITY

This fixture is dimmable and compatible with these dimmers sold at The Home Depot.

Make sure the lights are in a single pole with the dimmers, and the total wattage of the lights do not exceed the dimmer wattage capacity. Please refer to wattage capacity on the dimmer packaging.

Please contact customer service if you have further questions on the lights or dimmers.

Lutron Brand:

- DVWCL-153PH-WH / 530826
- CTCL-153PDH-WH / 267858
- TGCL-153PH-WH / 527401

Leviton Brand:

- R12-06672-1LW / 1000024040

Installation - Surface Mounting

1 Removing the end cap

- Use a flathead screwdriver to remove the end cap (C).

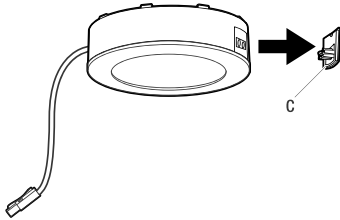

2 Preparing the lights for the first time

- Separate the trim ring (B) by pushing on the back of the LED puck assembly (A).

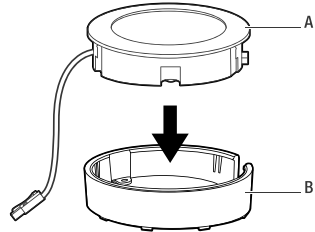

3 Installing the trim rings

- Attach the trim ring (B) to the desired surface, mark the screw location. Make sure the direction of outlet hole meets your requirement.
- Pre-drill holes in the mounting surface with a 1/16 in (1.5mm) drill to make installing screws easier.
- Install the trim ring (B) to the underside of the cabinet by inserting two mounting screws (AA) into the mounting holes on the bottom of each trim ring (B).

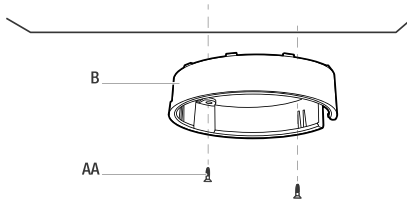
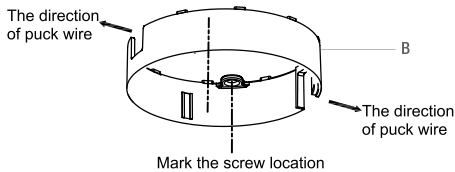

4 Installing the first LED assembly

- Take the cord from the LED puck assembly (A) and feed the cord through the outlet hole of the trim ring (B).
- Push the LED puck assembly (A) into the trim ring (B) while pulling the cord tight.

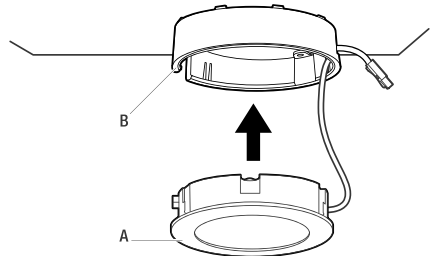

Installation - Surface Mounting (continued)

5 Installing the remaining four LED assemblies

- Repeat steps 1 through 4 to install the remaining four LED puck assemblies (A).



NOTE: 1) Ensure the LED puck assemblies install in the same direction so that you can easily connect the LED puck assemblies (A) with each other. 2) Measure the distance of every LED puck assembly (A) before installation.

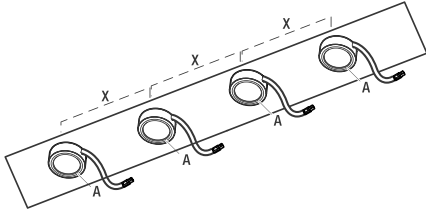

6 Connecting the LED puck lights

- Connect the LED puck assemblies with each other. Connect the power cord (D) to the fixtures.

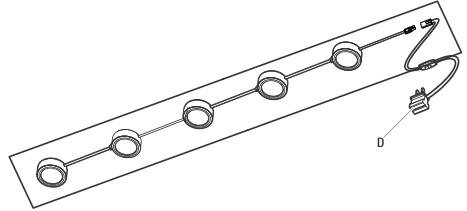

7 Securing the cords

- Use nail-on fasteners (BB) to attach the wire on the cabinet.
- Re-attach the end cap (C) on the last LED puck assembly (A).

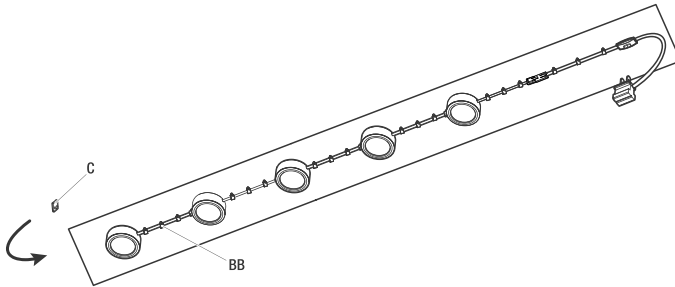

Installation - Recessed Mounting

1 Preparing the lights for the first time

- Repeat steps 1 through 2 in the Surface Mounting installation section of this document.
- Drill a 2.95 in. round hole into the installation area.



IMPORTANT: Ensure that you measure the distance of every LED puck assembly (A) before drilling the installation holes.



NOTE: The depth of installation area cannot exceed 0.2 in.

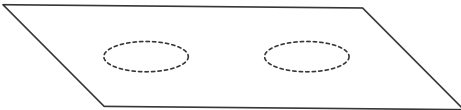

2 Inserting the LED lights

- Thread the wire from the LED puck assembly (A) through the hole and insert the fixture into the hole. Repeat steps 1 through 2 in the Surface Mounting section for the remaining four LED assemblies (A).
- Connect the LED puck assemblies (A) with each other and connect the power cord (D) as described in step 6 in the surface mounting installation section.



NOTE: When inserting the fixture, put the connector part into the hole first.

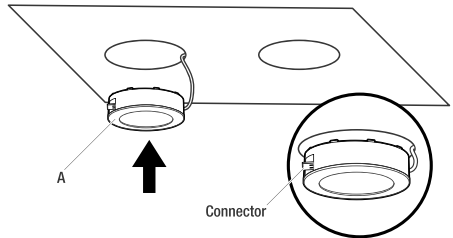

Direct Wire Installation (optional)

Convert to Direct Wire:

- Directly wire this fixture to a wall switch using Direct Wire junction Box (SKU1006126385), Sold separately.

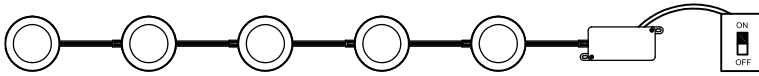

Installing the quick connector plug (optional)

- The fixture wire (1) can be cut to the desired length if necessary. This help to minimize the amount of wire underneath the cabinets.
- Remove the plug cover (2) from the plug (3).
- Press the fixture wire (1), with grooved side (4) to the right (neutral side) down and into the front of the plug (3).
- Press the fixture wire (1) down onto the metal prongs.
- Slide the plug cover (2) back onto the plug over the fixture wire(1).

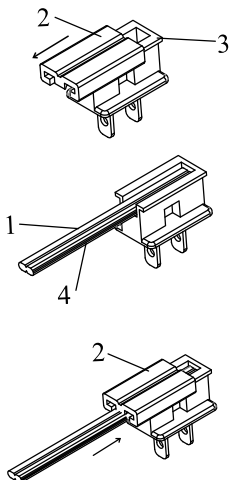

Luminous Intensity Distribution

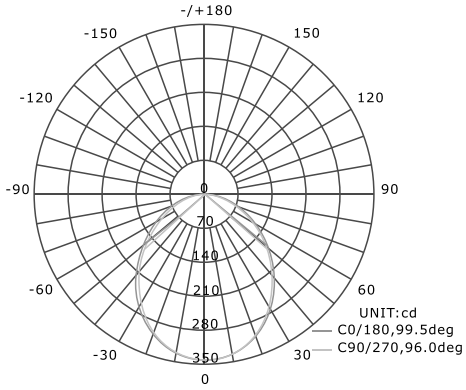



Questions, problems, missing parts? Before returning to the store,
call Commercial Electric Customer Service
8 a.m. – 7 p.m., EST, Monday - Friday, 9 a.m. - 6 p.m., EST, Saturday

1-877-527-0313

HOMEDEPOT.COM

Retain this manual for future use.