

JAFANDA
Better air for you

Jafanda LLC.

1309 Coffeen Avenue STE 4304
Sheridan, Wyoming 82801
support@jafanda.com

EPA Est.NO.98581-CHN-1
Made In China



JAFANDA

JF239 Air Purifier User Manual

READ AND SAVE THESE INSTRUCTIONS

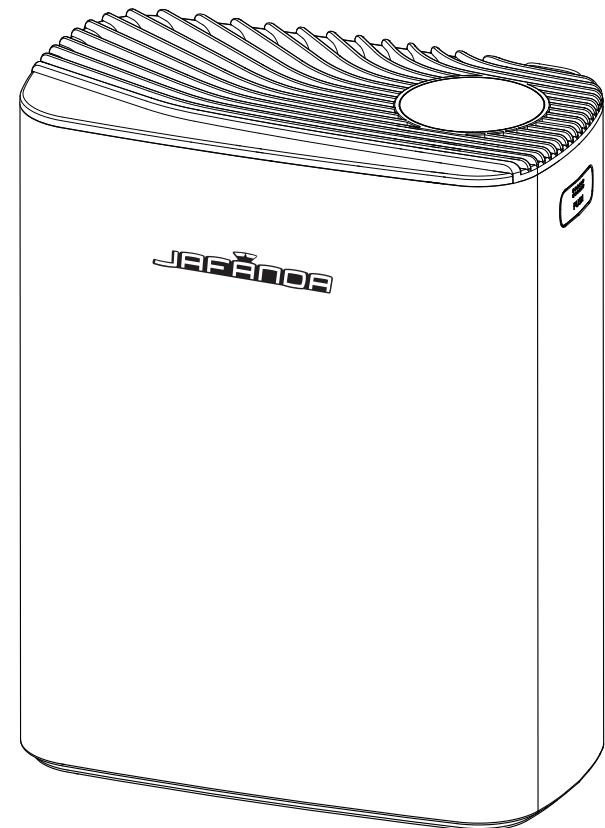

THANK YOU FOR YOUR PURCHASE!

Contact our support team by Email:
support@jafanda.com

Join the jafanda Community on Social Media



@JAFANDA.COM



TABLE OF CONTENTS

Package content	1
Specifications	1
Safety information	2
Getting to know your air purifier	3
Product features	4
Operating instructions	5
Using your air purifier	7
Care & Maintenance	8
Replacement filters	9
Troubleshooting	10
Warranty & Support	11
Returns & Refunds	11

Package content

Package content

JF239 Air Purifier	1 pcs
Ture HEPA Filter	1 pcs (assembled in the appliance)
AC Power Adapter	1 pcs (DC 24V)
User Manual	1 pcs
Aroma Pad	4 pcs



Specifications



PRODUCT TECHNICAL

Product name	Air Purifier	Model	JF239
Power Adapter (Input)	100-240V~ 50/60Hz	Product size	11.73x 6.22 x 14.76 in 29.8 x 15.8 x 37.5 cm
Power Adapter (Output)	24V = 1.5A	Package Size	13.11 x 7.48 x 17.44 in 33.3 x 19.0 x 44.3 cm
Rated Power	35W	N.W.	7.05lb/3.2kg
CADR (Clean Air Delivery Rate)	158CFM (268m ³ /h)	G.W.	8.82lb/4.0kg
Noise Level	Low Speed:20dB High Speed:52dB	Standby Power	< 2W
Operating Conditions	Temperature: 14°F-104 °F/-10 °C-40 °C Humidity: 20%-95% RH	Filter life	3000H
		Room Area Served	245ft ² (5 Times/h) 613ft ² (2 Times/h) 1226ft ² (1 Times/h)

Safety information

Please observe the following safety precautions and read the relevant instructions carefully before using this product!

 Prohibition	Any content with this mark must be prohibited, otherwise it may cause damage to the product or endanger the user's personal safety.
 Warning	Any content with this mark must be operated in strict accordance with the requirements, otherwise it may cause damage to the product or endanger the user's personal safety.
 Important	Any content with this mark must be paid attention to, otherwise it may cause damage to the product or other losses due to improper use.

	Do not touch the power plug with wet hand.		Only configured power cable can be used.
	Do not block the air inlet/outlet.		Please remove dust from the product body and power plugs periodically.
Do not use the product in rooms with greasy particles or moisture like shower room.	Please be careful when cleaning the air purifier. Strong corrosive detergent will damage the surface of the device.		
Do not clean or reuse the high efficiency composite mesh.	Do not use the product near or on heat source objects (such as fireplace, heater or places that may be exposed to flammable gas).		
	This product is not suitable for the physical disabled, the visual disabled, the mental disabled and children unless the safety responsible person on the spot for supervision and provide guidance.		Remove the plug from the power socket when cleaning or not using the machine. Otherwise, it may cause electric shock due to loose connect or cause fire due to short circuit.
	Contains FCC ID: 2ANDL-WBR3 This device complies with part 15 of the FCC Rules. Operation is subject to the following two conditions: (1) This device may not cause harmful interference, (2) this device must accept any interference received, including interference that may cause undesired operation.		
	This air purifier is suitable for floor standing. With caster wheels, it's easy to move in-house. Do not place the air purifier closer than 10cm/4" to wall or another object..		

Getting to know your air purifier

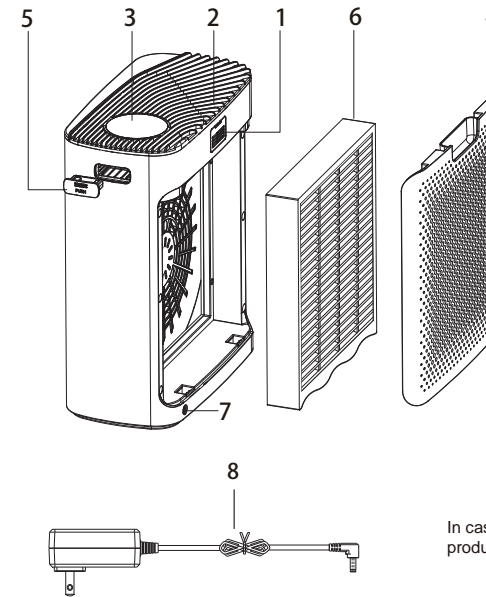

- ① PM2.5 sensor
- ② Air outlet Grid
- ③ Display
- ④ Filter cover
- ⑤ Fragrance Box
- ⑥ Filters
- ⑦ Supply Hub
- ⑧ AC Power Adapter

In case of a discrepancy between the product picture and real product, the real product will prevail.

Display

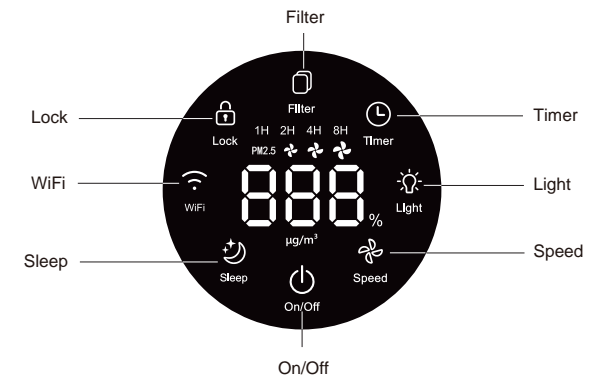

Product features

Combine Multiple Functions

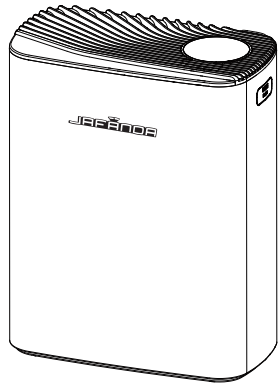

- High-Efficiency Purification: Remove PM 2.5, smog, pollen and other particulate pollutants.
- Built-in essential oil box and aroma pad, add essential oil to freshen the air continuously
- 3 fan speeds
- Timer (1-8H)
- Filter replacement indicator
- Manual, Auto, Sleep, and other operating modes
- Child lock
- Real-time value display of PM2.5
- WiFi control

3-Stages Filtration System

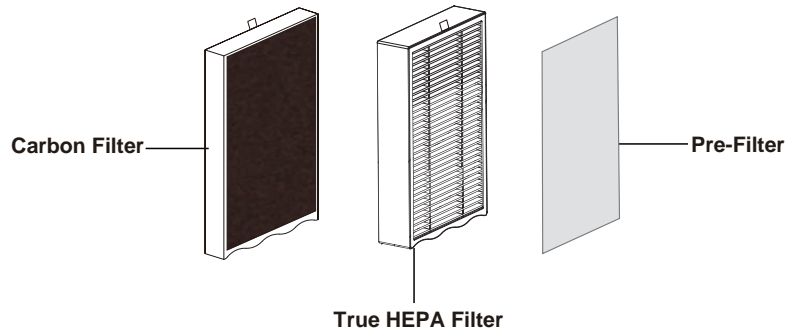

Pre-Filter	Intercepts hair, dander, fibers, and particles of visible large size. Can be vacuumed regularly.
True HEPA Filter	Removes at least 99.97% of airborne particles 0.3 micrometers (μm) in diameter, Captures particles as small as 0.015 micrometers (μm), Filters small particles such as PM2.5, smoke, pollen, dust, and other pollutants.
Carbon Filter	Absorb and eliminate fumes and volatile organic compounds in the air.

Note: Carbon Filter, True HEPA Filter and Pre-Filters are compounded in the same filter.

Operating instructions

- ⚠ Precautions for use**
- All filters are included inside the air purifier.
 - Before use, make sure the plastic bag outside the filter is removed and installed properly.

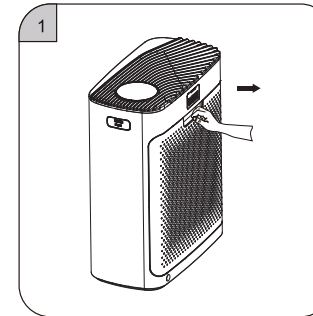

1. Press down the button on rear cover plate and pull it out slightly, then take out Filter.

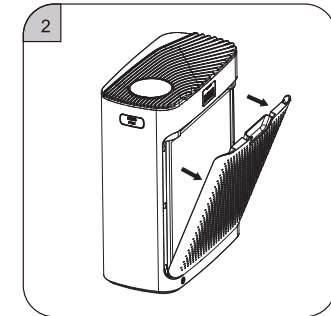

2. Lift the filter cover from the air purifier.

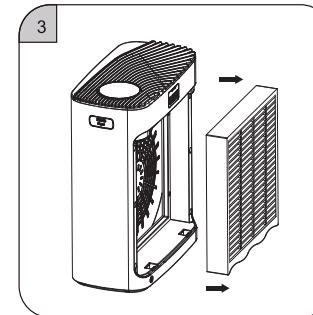

3. Take out the new filters with plastic packaging.

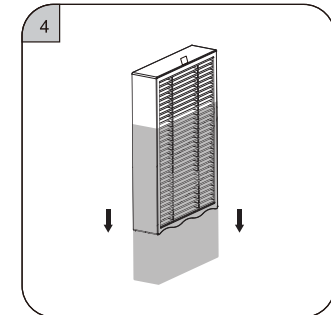

4. Remove the protective film on the filter before use.

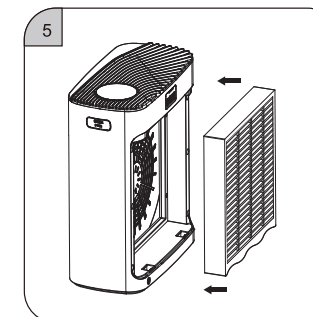

5. Put into New Filter without protective film.

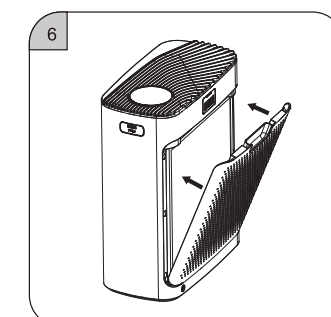

6. Close the rear cover plate, then it is done.

Operating instructions

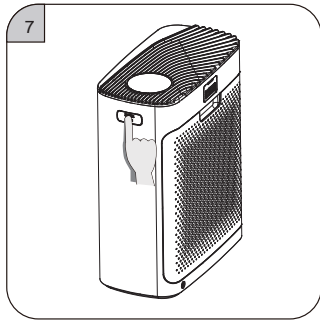

7. Press the essential oil box and the box will pop up.

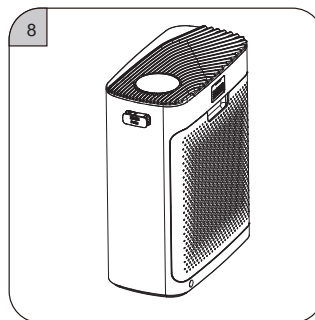

8. Take out the essential oil box.

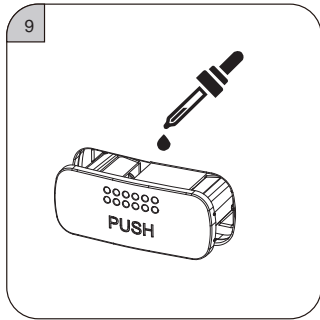

9. Add an appropriate amount of essential oil to the aroma pad inside the essential oil box (Be careful not to overflow).

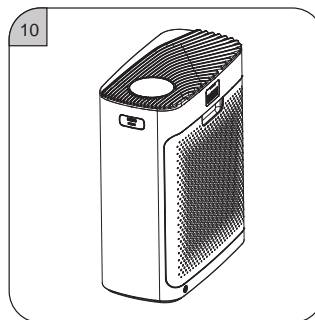

10. Put the essential oil box in and buckle it up in place.

Getting Started

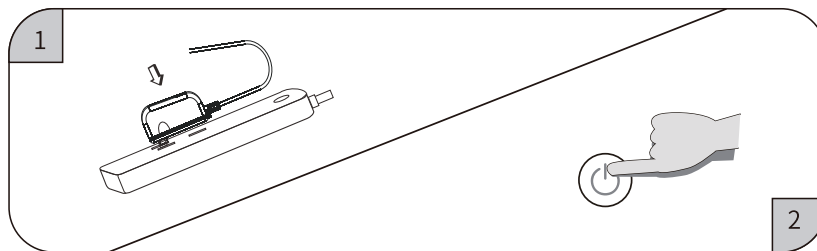

- ① When it's powered on, there is a "DING" sound.
- ② Touch the POWER switch key to start the purifier.

Using your air purifier



Power Button

Press the "⏻" to turn the device on or off. White light indicates power on. Red light indicates standby state.



Sleep Button

Press the "🌙" while on to enter sleep mode. In sleep mode, only the "🌙" is lit, other lights are off, wind speed is at gear 1, and the "🌙" turns off after 10 seconds. Touch any button to turn the "🌙" light back on. Press the "🌙" within 10 seconds to exit sleep mode and return to the previous settings.



Light Button

Press the "💡" to adjust the ambient light brightness: full bright, half bright, off. In the off state, the screen and light button turn off after 10 seconds. Wind speed remains at the current setting. Touch any button to turn the light back on. Press the "💡" again within 10 seconds to light up the display and exit the screen-off mode.



Filter Life Button

Press the "📄" to display the remaining filter life percentage. The PM2.5 number changes to show the filter life with a percentage symbol, then resumes after 3 seconds. A flashing red light on the "button" indicates the filter life is below 5%. Press and hold the "📄" for more than 3 seconds to reset the filter life. A "ding" sound will confirm the reset, and the "📄" light will return to half-lit white.

Forced Filter Life Reset:

While unplugged, plug the device back in within 30 seconds. In standby mode, press and hold both the "📄" and "🌙" for more than 3 seconds. A "ding" sound will confirm the reset, the screen will flash for 3 seconds and then turn off, indicating successful forced reset and filter life restored to 100%.



Child Lock Button

In working mode, press and hold the "🔒" for more than 3 seconds to activate child lock. The "🔒" will be fully lit, and all other buttons will be disabled. Press and hold the "🔒" again for more than 3 seconds to deactivate child lock and restore other button functions. The "🔒" light will return to half-lit.



Wi-Fi Button

With the device powered on, press and hold the "📶" for 3 seconds. The "📶" will start flashing, indicating the device is ready for network connection. Follow the app instructions to complete the network setup. The "📶" will stay lit if the network configuration is successful. If unsuccessful after 10 minutes, the "📶" will be half-lit.



Timer Button

Timer Shutdown:

With the device on, press the "🕒" repeatedly to cycle through shut-off timer options: 1 hour, 2 hours, 4 hours, and 8 hours. Stop pressing the "🕒" for more than 3 seconds to confirm the timer setting and start the countdown.

Scheduled Power-On:

In standby mode, press the "🕒" repeatedly to cycle through power-on timer options: 1 hour, 2 hours, 4 hours, and 8 hours. Stop pressing the "🕒" for more than 3 seconds to confirm the timer setting and start the countdown.



Wind Speed Button

While on, press the "🌀" repeatedly to cycle through: smart mode, gear 1, gear 2, and gear 3. The current gear is displayed on the screen. In smart mode, the wind speed and air quality indicator light color adjust automatically based on the PM2.5 concentration.

PM2.5 value	Air quality	PM2.5 air quality indicator	Wind speed gear
0-12	Excellent	Green	1
13-35	Good	Blue	2
36-55	Poor	Yellow	3
≥56	Severe	Red	4

Care & Maintenance

THE ADAPTER MUST BE UNPLUGGED BEFORE ANY MACHINE MAINTENANCE OPERATION.

1. CLEANING THE BODY OF THE DEVICE (RECOMMENDED ONCE A MONTH):

- 1) Use a soft cloth to remove stains.
- 2) Stubborn stains that are not easy to clean can be wiped off with a soft cloth dipped in an appropriate amount of neutral detergent.

Note: do not use hard objects to scratch the machine shell. When removing the base, follow the instructions to avoid damaging machine parts.

2. FILTER CLEANING AND REPLACEMENT :

1) Filter replacement will be reminded by the built-in program, which can be replaced according to the service life of the machine, or can be replaced in real-time by the filter's mandatory service life reset function.

2) when dust accumulates on the surface of the composite filter, you can use a vacuum cleaner to clean the surface dust, to extend the service life of the filter (it is recommended to clean once a month. Do not wash).

* Depending on the machine's environment, the filter's life will be different. For example, in places where people smoke and pets are present, the life of the screen is shorter. When the purification effect is not good, replace the filter in time.

* Please dispose of the used waste filters according to the relevant regulations of solid waste.

Replacement filters

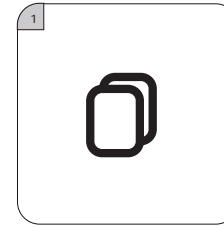

1. When the filter reset button lights red, it prompts the user to replace the filter

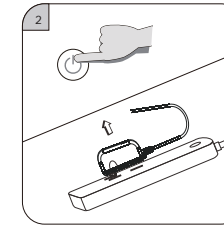

2. Touch the POWER button to turn off the machine and unplug the adapter.

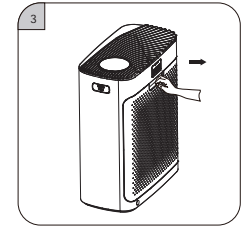

3. Press down the button on rear cover plate and pull it out slightly, then take out Filter.

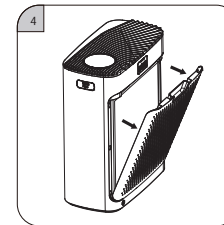

4. Lift the filter cover off from the air purifier

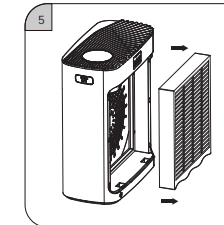

5. Take out the old filter from the machine

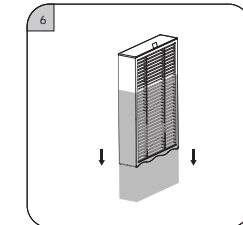

6. Remove the protective film on the filter before use.

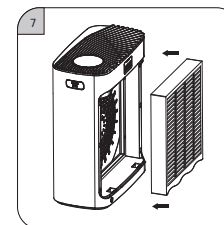

7. Put into New Filter without protective film.

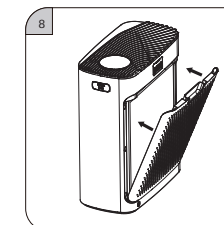

8. Close the rear cover plate, then it is done.

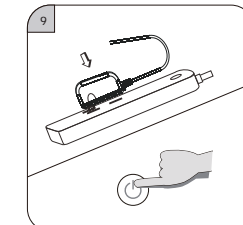

9. Plug in the adapter and touch the POWER button to restart it.

Troubleshooting

PROBLEM	POSSIBLE CAUSE	POSSIBLE SOLUTION
The product is not working properly	1. The connection is faulty. 2. The filter cover is not properly installed.	1. Check whether the plug is inserted into the socket and whether the POWER ON/OFF button is turned on. 2. Reinstall the filter cover.
Fresh air doesn't flow smoothly out of the outlet	1. The plastic package of the new air filter has not been removed. 2. The air outlet of the purifier is blocked by foreign objects.	1. Remove the packing plastic bag first. 2. Remove foreign bodies.
The machine makes an abnormal sound during the operation	1. The air intake vent or air exhaust vent is blocked by foreign bodies. 2. Foreign objects fall into the air duct of the machine.	1. Please move the obstructing object. 2. Remove the foreign body.
Feel the wind weakening	1. The life of the filter has expired, or the filter is blocked by hair.	1. Use a vacuum cleaner to clean dust and hair on the surface of the filter; Replace the expired filter screen.
The air purifier gives off a bad smell	1. The concentration of environmental pollutants may be too high, and the filter screen may suffer early saturation.	1. The filter needs to be replaced to avoid secondary pollution.

The most Frequently Asked Questions about this product are listed here. If you cannot find the answer to your question, please contact our after-sales service department.

Warranty & Support

Jafanda products have a One Year warranty from the date of purchase and a Free Extended One -Year warranty after registering your product with your order and purchase date via <https://www.jafanda.com/pages/warranty-registration>. Jafanda always takes responsibility for all our products. Jafanda always pays high importance to the customer's purchase experience and satisfaction.

Returns & Refunds

If for any reason you are not fully satisfied with your purchase experience within 30 days, we are happy to help with a replacement or refund. For more detail, please visit our after-sales website page: <https://www.jafanda.com/policies/refund-policy>.