

User manual

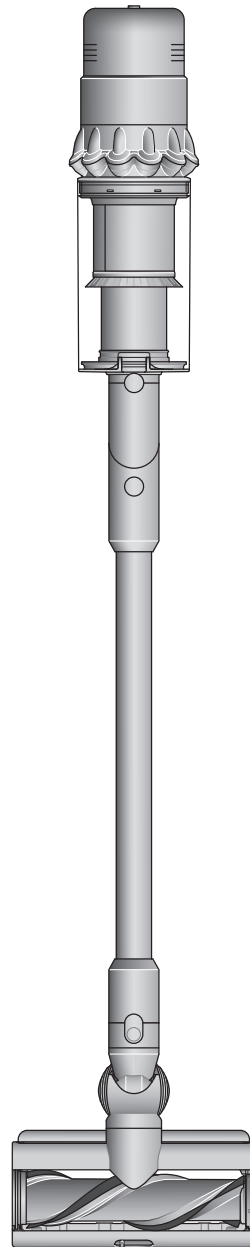

Top view of the Dyson Gen5 detect machine, showing cleaner head, wand, bin and main body.

Contents

In the box

Getting started

The LCD screen

Alerts

Caring for your floors

Charging your machine

Changing your click-in battery

Emptying your bin

Cleaning your bin

Clearing blockages

Clearing obstructions from your

Digital Motorbar™ cleaner head

Clearing blockages from your

Hair screw tool

Washing your filter

Washing your Fluffy Optic™ brush bar

Scratch-free dusting brush

Awkward gap tool

Cleaning your tools

Looking after your machine

In the box

Your machine will come with one, or both, of the cleaner heads shown here.

Main body showing the bin and battery attached.

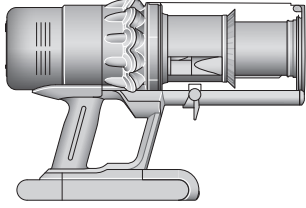

Vacuum cleaner with battery and bin attached

A soft fluffy brush bar housed within the cleaner head. There is an electrical connector end that can attach to the end of the wand or directly to the machine.

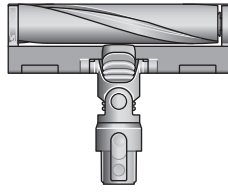

Fluffy Optic™ cleaner head

A precisely-angled blade of light makes invisible dust visible on hard floors.

A brush bar located inside the cleaner head and a suction control slider located on the front.

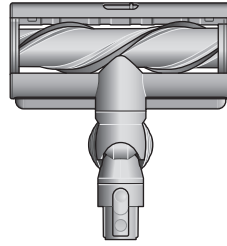

Digital Motorbar™ cleaner head

Dyson DLS™ technology monitors brush bar resistance and adapts power across different floor types. Hair removal vanes prevent tangling around the bristles.

The charger is a one piece unit with the plug, connector end and cable.



Charger

Charges your vacuum with or without a dock.

A rectangular dock that needs to be fixed to a wall with screws.

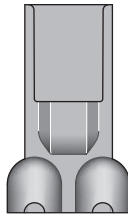

Wall dock

The Dyson cordless vacuum drops into the wall-mounted charging dock, ready for your next clean.

Dyson wand, with a built-in dusting and crevice tool, convenient for on-the-spot cleans.



Wand with Built-in dusting and crevice tool

Stored inside the wand is a ready-to-go crevice tool for on-the-spot cleans.

Some tools may not be included.

You can buy additional tools at www.dyson.com.

This tool has a combination of brush head and crevice tool together in one unit. The brush head slides down the crevice tool when needed.



Combination tool

Two tools in one – wide nozzle and brush, for quick switching between cleaning and dusting tasks around your home or car.

A small cleaner head with an angled body housing the motor and an electrical connector to attach to the wand or directly to the machine.



Hair screw tool

Anti-tangle conical brush bar spirals hair off and into the bin. Motor-driven cleaning for smaller spaces.

The Scratch-free dusting brush has a head made of soft bristles for cleaning delicate surfaces.



Scratch-free dusting brush

Gentle on delicate surfaces. Self-cleaning – a rotating cuff keeps the soft bristles clear of dust.



The Awkward gap tool is long and slim, with a 22 degree twist, for cleaning tight gaps and hard-to-reach places.

Awkward gap tool

Long and narrow, with a 22° twist to clean car storage compartments, tight gaps and hard-to-reach places.



A flexible hose engineered from tough wire and durable plastic.

Extension hose

Adds up to **61cm** of flexible reach to any tool attachment, to clean up high or down low in your home or car.



Pliable bristles and felt bumper strip on a narrow, tapered tool.

Soft dusting brush

Enclosed in a skirt of soft nylon bristles for gentle, vacuum-assisted dusting of delicate objects and surfaces.

A short nozzle with stiff bristles on the underside.



Stubborn dirt brush

Stiff nylon bristles dislodge ground-in dirt from coarse carpets, high traffic areas and car interiors.

With an elbow joint, fitted between the bin and the tool.



Low-reach adaptor

Bends to comfortably reach down low. Engineered to clean further under low furniture by adjusting the wand angle up to 90°.



A long tool with an angled end.

Light pipe crevice tool

Crevice tool with LED lights lets you reach into dark, narrow spaces and see where you're cleaning.



A jointed connector that creates a flexible joint between the machine and the tool. It must be used in conjunction with a tool or cleaner head.

Up-top adaptor

Bends and locks at different angles. For effective cleaning in hard-to-reach high areas of your home.

A wide, triangular shaped nozzle.

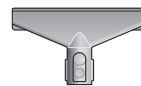

Fabric and mattress tool

Removes dust, dirt and allergens from mattresses and upholstery.

A plastic clip that attaches to the wand



Wand clip

Clips to your vacuum's wand to hold tools.

Getting started

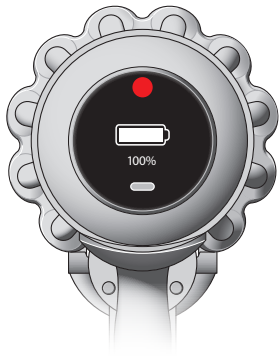

Screen on the filter end of the machine.

Using the LCD screen



Finger pressing the selection button on the screen to move between power modes.

Power modes

Your machine has three power modes for different tasks. Change power modes quickly using the silver Selection button.



The screen showing the machine set to Eco mode with a full battery in green to show that this will give the longest battery life of the three modes.

Eco mode

Maximum run time for longer cleans all around your home.



Two screens showing the machine set to Auto mode and Med mode with a blue battery showing that this will give a medium length of battery life.

Auto and Med mode

Medium mode for the optimum balance of power and run time. Attach your cleaner head or Hair screw tool to activate Auto mode. Suction power automatically adapts to dust levels.



The screen showing the machine set to Boost mode with a red battery to show that this will give the shortest battery life of the three modes.

Boost mode

Designed for intensive spot cleaning of ground-in dirt.

Location of the Selection button on the screen on the filter end of the machine.

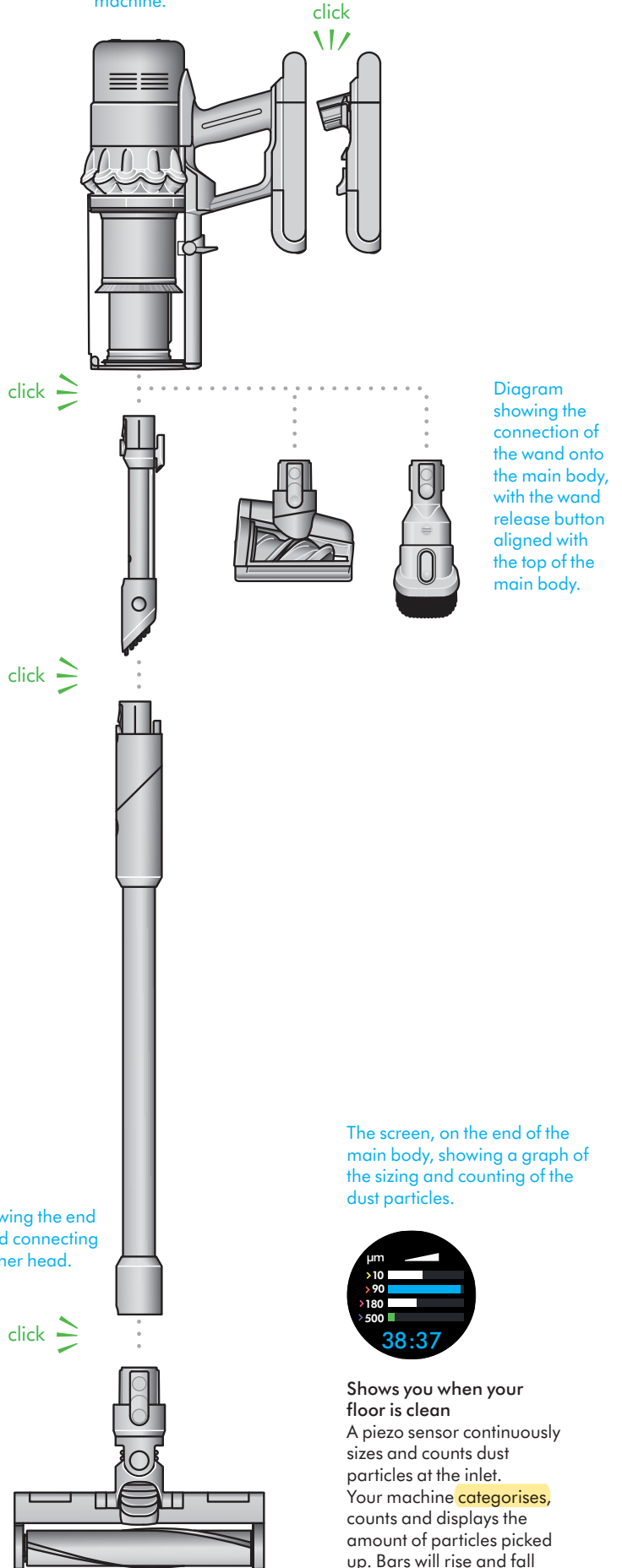

Diagram showing the connection of the wand onto the main body, with the wand release button aligned with the top of the main body.

The screen, on the end of the main body, showing a graph of the sizing and counting of the dust particles.



Shows you when your floor is clean

A piezo sensor continuously sizes and counts dust particles at the inlet. Your machine **categories**, counts and displays the amount of particles picked up. Bars will rise and fall depending on the amount of debris and dust detected – showing you in real-time when your area is clean.

The LCD screen

Settings menu

Control the settings on your machine using the Selection button. To enter the settings menu, press and hold the button until the menu screen appears. Press the button to move through the options within the settings menu.

Hold the button to open an option.

- Language
- Alerts
- Serial numbers

For more information and support for your machine go online: www.dyson.com/support

The Selection button on the screen being pressed.

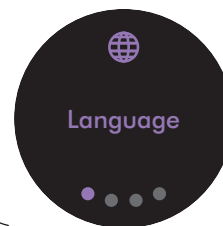
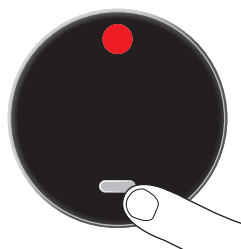

In the settings menu, the Language option allows you to select your screen's language preference.

In settings, the Alerts option allows you to set the on-screen alerts to On or Off.

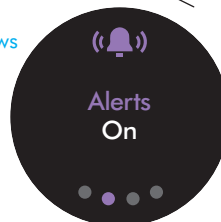

In settings, the third screen option allows you to view Serial numbers.

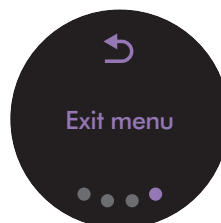

The Exit menu screen is the final option in settings.

Change language

To change the language on your screen, press the Selection button and hold it until the language list appears. Release the button.

Tap the Selection button to scroll through the language list to your preferred language. Press and hold the button until the countdown ends.

A green tick will appear on the screen to show your language selection is complete.

To cancel your selection, release the button during the countdown.



In the settings menu, the Language option allows you to select your screen's language preference.

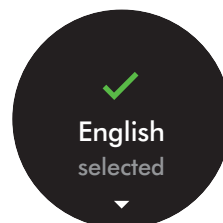

Two screens, the first with the language list and then the tick screen to show that the language has been successfully changed.

Find your serial numbers

You can find your serial numbers in the settings menu.

Press the Selection button to move through the settings sequence until you reach Serial numbers.

Press and hold the button to select this option.

Press the button to move through your serial numbers information.



The Serial numbers screen is the option for searching for your serial numbers.

Run time countdown

When the battery needs charging, your machine will pulse three times and a Low run time icon will appear on the screen.

Low run time will be in amber, or red when in Boost mode.

When your battery is empty, a red warning icon will appear on the screen.

The screen reads Low run time, surrounded by an amber circle, when the battery needs charging.



The screen reads Low run time, surrounded by a red circle, if the battery runs low while in Boost mode.

A red screen with an icon with a plug being connected to the power supply. This demonstrates the battery is empty and needs charging.

Battery health and Boost advice

To get the best performance and life from your battery, use Eco or Auto/Med mode.

If you use Boost mode frequently, this message may appear, to help you conserve your battery life.



The battery health is shown on the batteries on the screen.

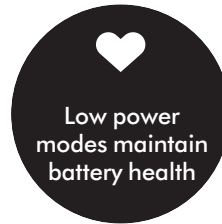

Alert with a white heart icon, reads 'Low power modes maintain battery health'.

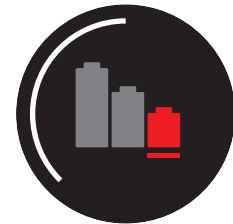

An alert with three battery icons, large, medium and small. The first two coloured grey to indicate empty. The third is red, indicating very low battery.

Exit settings menu

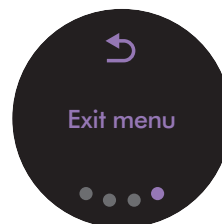

Screen with 'Exit menu' wording and return icon.

Alerts

The alerts you might see are:

Airway obstructed

Your machine has a blockage that needs removing. Watch the animation to see which airways to check. Make sure your machine is turned off before removing a blockage.

Alert icon with 'Airway obstructed' wording.



A pair of spectacles observing the bottom of a cleaner head is an obstruction warning directing you to investigate a blocked cleaner head.

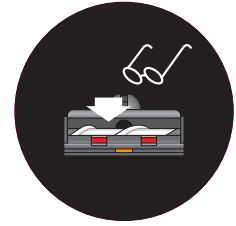

High storage temperature

Your machine is being stored in a place where the temperature is too high. Move your vacuum to a cooler place.

Alert icon with 'High temperature detected' wording.



A vacuum handle icon, surrounded by four three-pronged, red heat symbols, is an alert signalling your vacuum is too hot – and should be stored clear of a heat source.

Cold temperature

Your machine is too cold. Move your vacuum into a warmer environment and leave to warm up.

Alert icon with 'Machine too cold' wording.



Alert icon with 'Leave to warm up' wording.

Non-Dyson battery

A non-Dyson battery has been detected. If you are not aware that you are using a third party battery for your machine, this may be a counterfeit.

Alert icon with 'Non Dyson battery detected' wording.



Alert warning icon reads 'Use genuine parts to protect your machine'.

Alert icon with 'Refer to compliance and...' wording.



Alert icon with '...safety information' wording.

Clean filter

Your filter needs cleaning. Please refer to 'Washing your filter'.

After cleaning, leave to dry for at least 24 hours before reattaching it to your machine.

Alert icon with 'Filter needs cleaning' wording.



Alert icon with a filter graphic and '24+' reminds you to leave your filter to dry for 24hrs after washing.

Filter not sealed

Your filter isn't properly fitted. Twist your filter **anti-clockwise** and pull it away from your machine. Reattach to your machine, twisting it clockwise until it locks into place.

Alert icon with 'Filter not sealed' wording.



Change alert settings

You can turn the alert motor pulse off. Your motor will no longer pulse but run time alert information will continue to be displayed on the LCD screen when your machine needs your attention.

Turning off alerts will not turn off the blockage alert pulsing. This is to ensure you clear any blockages, preventing damage to your machine.

Make sure you have entered the settings menu. Tap the Selection button to move through the options within the settings menu. Press and hold the button to select the 'Alerts' option.

Tap the button until your selection is highlighted. Hold it down until the countdown ends and a tick appears on the screen. To cancel your selection, release the button during the countdown.



The Alerts screen allows you to choose On or Off.

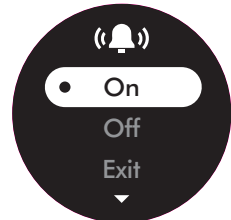

The Alert settings menu reads On, Off, Exit.

Caring for your floors

Check that the underside of the cleaner head or tool is clean and free from any objects that may cause damage.

Before vacuuming your flooring, rugs, and carpets, check the manufacturer's recommended cleaning instructions.

The brush bar on your machine can damage certain carpet types and floors. Some carpets will fuzz if a rotating brush bar is used when vacuuming. If this happens, we recommend vacuuming without the **motorised** floor tool and consulting with your flooring manufacturer.

Charging your machine

You can use your machine immediately, or charge it partially, without the need to fully charge before first use.

Connect to the charger, either directly or in the dock.

The blue LEDs on both sides of the battery will flash during charging.

When the battery is fully charged, both LEDs will light for five seconds.

Your battery is fully charged when the display shows 100%.

Your machine won't operate or charge if the ambient temperature is below 5°C (41°F). This is designed to protect both the motor and battery.

The charger connected from the power supply using the wall dock.

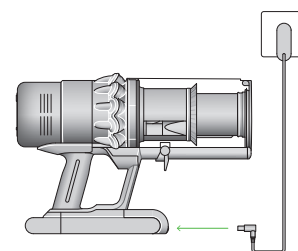
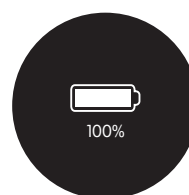

The charger connected from the power supply directly into the front of the battery.

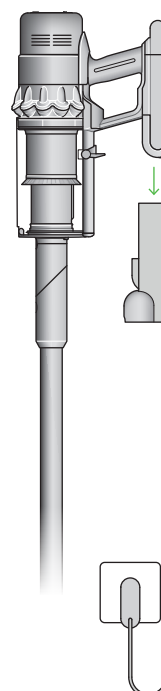

Changing your click-in battery

If you have additional click-in batteries, we recommend that you alternate the batteries to maintain even performance.

Removing your battery

Push the Battery release button at the front of the battery unit, and slide the battery off your machine.

Charge the battery.

Refitting your battery

Align your battery with the handle and slide it in. Push firmly until it clicks into place.

Arrows showing the location of the Battery release button at the front of the battery unit, and the battery coming off the handle when the button is pressed. The battery is then shown being replaced on the base of the handle, clicking into place.

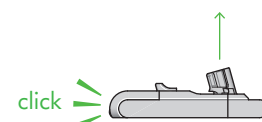
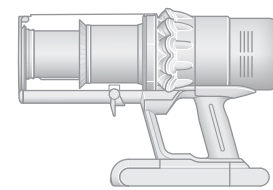
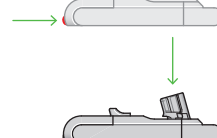
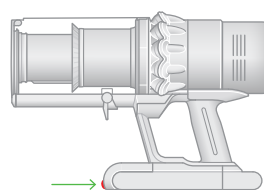

Emptying your bin

Empty as soon as the dirt reaches the MAX level – don't overfill. Using your machine when the dirt is above the MAX line may affect the performance and require more frequent filter washing.

Overfilling your bin could result in inaccurate readings on the particle graph.

Make sure your machine power is turned off before removing your wand or releasing the bin.

Remove your wand

Press the grey wand release button, on the top of the wand, and pull the wand away from the bin.

Release the dirt

Hold the machine over the bin, pointing downwards.

Firmly push the red bin release button. The bin will slide down, cleaning the shroud as it goes, and the bin base will open.

The bin base won't open if the red bin release button isn't pushed down all the way.

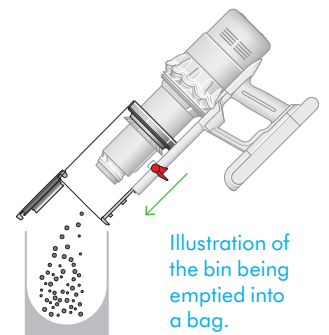

Minimise dust contact

Cover your bin tightly in a dustproof bag while you empty. Remove your bin carefully, seal the bag tightly and dispose.

Close the bin

Push the bin base upwards until your bin and bin base click into place.

The bin lid closing with an audible click and the bin being pushed upwards with another click once it is fully in place.

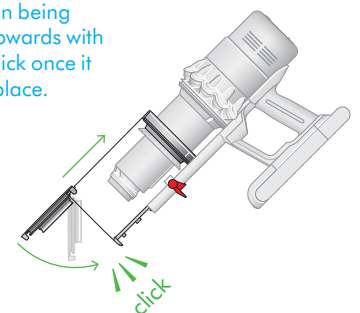

Cleaning your bin

Remove your bin

If you need to clean your bin, empty it as shown in the 'Emptying your bin' section.

Press the red button located on the bin runner to release the bin and slide your bin off the runner.

Clean your bin using a damp, lint-free cloth.

Make sure that your bin and seals are completely dry before refitting.

Your bin isn't dishwasher safe and the use of detergents, polishes or air fresheners to clean your bin isn't recommended, as it may damage your machine.

Refit your bin

Insert the spine on to the bin runner.

Close your bin by pushing the bin base upwards until the bin and bin base click into place.

The bin being removed and the location of the bin release lever on the underside of the bin runner.

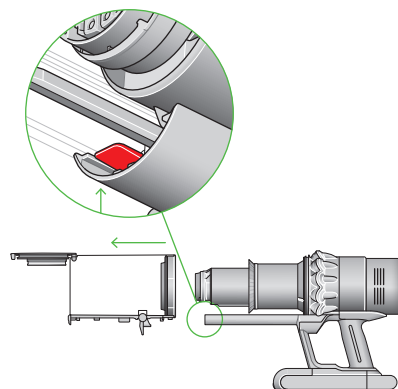

The bin being pushed back into position on the bin runner.

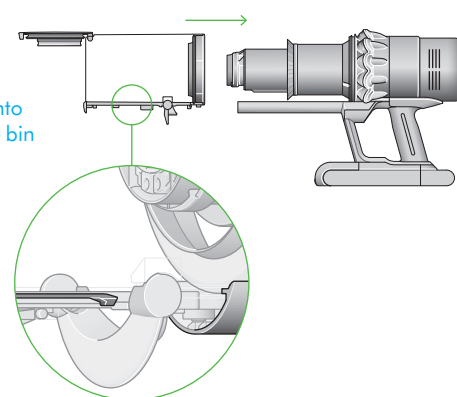

The bin base being closed as the bin is slid back onto its runner and into position.

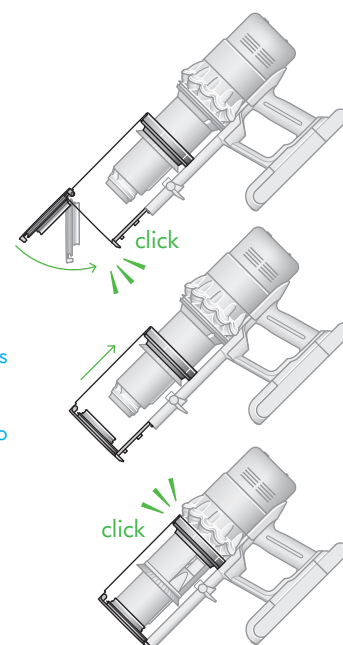

Clearing blockages

Disconnect your machine from the charger before looking for blockages. Make sure your machine power is turned off and be aware of sharp objects.

Leave your machine to cool down before looking for blockages.

Don't use your machine when looking for blockages as this could cause injury.

If your machine detects a blockage, the motor will pulse and you won't be able to use your machine until the blockage has been cleared.

If you try to use your machine when the motor is pulsing, it will automatically cut out.

Check the main body

Remove the bin and check for blockages in the main body of your machine.

Make sure any blockages are completely cleared and all parts are fitted before using your machine.

Check the wand and cleaner head

Check the wand for blockages.

Check your cleaner head for blockages, following the instructions to remove the brush bar, where necessary.

Re-assemble your machine

Refit all parts securely before using your machine.

Clearing blockages isn't covered by your guarantee.

With the bin removed, check for blockages, paying particular attention to the air inlet, located on the right-hand side of the machine just below the point where the bin joins the main body of the machine.

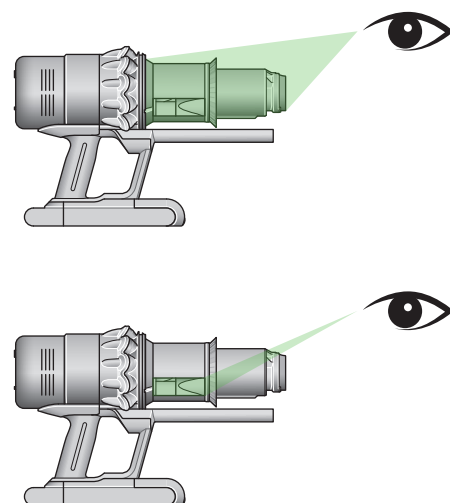

With the wand removed from the machine, check for blockages at both ends of the wand.



Turn the cleaner head over to check for obstructions on the brush bar and air inlet.

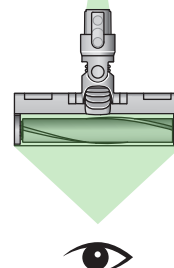

Clearing obstructions from your Digital Motorbar™ cleaner head

Your Digital Motorbar™ cleaner head doesn't have a washable brush bar. To maintain optimum performance, check your brush bar regularly and clear any obstructions.

Make sure your machine is disconnected from the charger and your machine power is turned off.

Don't put any part of your machine in a dishwasher or use detergents, polishes or air fresheners.

Remove your brush bar

Press the cleaner head release button on the end of the wand.
Place the cleaner head upside down.

Use a coin to unlock the end cap.

Turn the end cap and remove it from your brush bar. Don't wash the end cap.

Slide your brush bar out of the cleaner head.

Look for obstructions

Clear any debris from your brush bar.

Check inside the cleaner head and remove any debris or blockages.

Your Digital Motorbar™ cleaner head and brush bar aren't washable. Wipe over with a damp lint-free cloth.

Refit your brush bar

Push the end cap back on to your brush bar and slide it back into the cleaner head.

Turn the end cap 90° clockwise into the locked position.

The lock located on the side of the cleaner head, is rotated 90° anti-clockwise to release the end cap and the brush bar can be removed.

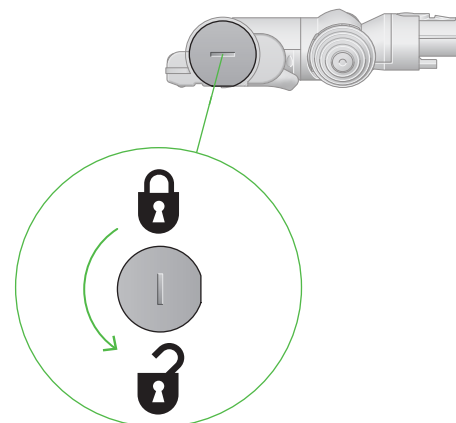

Clear debris alert is an X-ray style graphic of a brush bar inside a cleaner head. A green arrow indicates brush bar being pulled out of the cleaner head to the right.

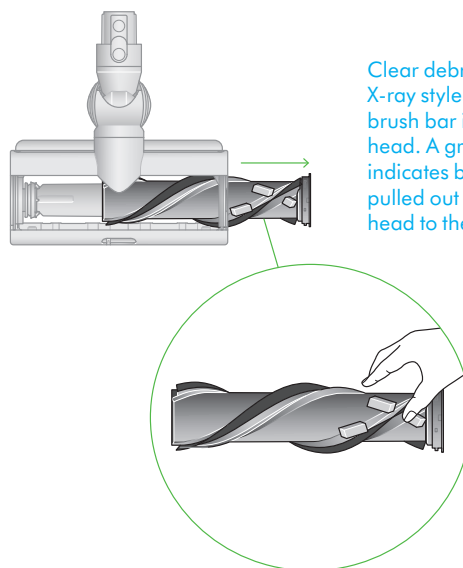

The removal of the brush bars showing the lock in a horizontal position and the unlock symbol at 90° anti-clockwise and lock symbol at 90° clockwise.

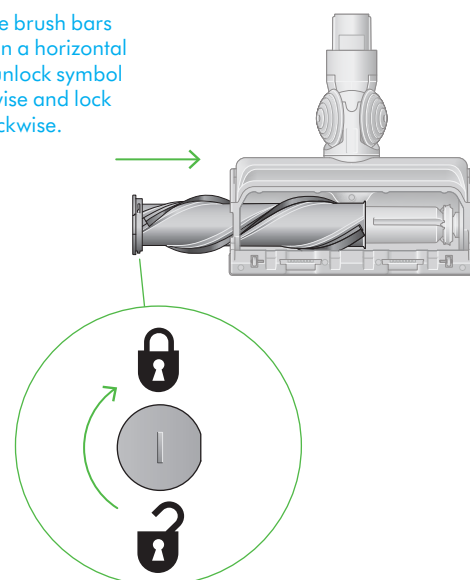

Clearing blockages from your Hair screw tool

Your Hair screw tool doesn't have a washable brush bar. To maintain optimum performance, check your brush bar regularly and clear any obstructions.

Make sure your machine is disconnected from the charger and your machine power is turned off.

Don't put any part of your machine in a dishwasher or use detergents, polishes or air fresheners.

Remove the cover and brush bar

Remove the Hair screw tool from the wand or machine.

Push the base plate open. Press the red lever down to release the cleaner head cover.

Pull the cleaner head cover off the main body of the tool.

Look for obstructions

Pull your brush bar firmly to remove it from the main body.

Check and remove any obstructions from all three parts of your Hair screw tool.

Your Hair screw tool isn't washable. Wipe over with a damp lint-free cloth.

The location of the lever to release the brush bar is located at the back of the Hair screw tool.

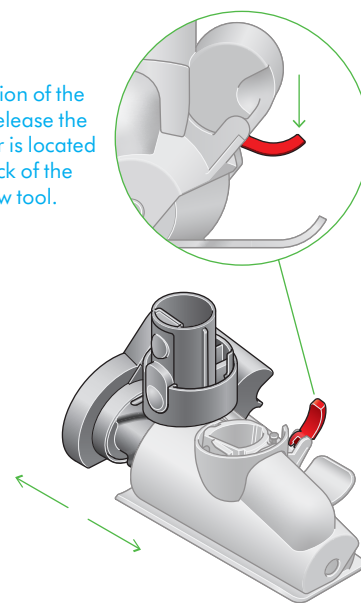

Slide the housing back on to the brush bar and push the lever on the back of the Hair screw tool upwards to lock.

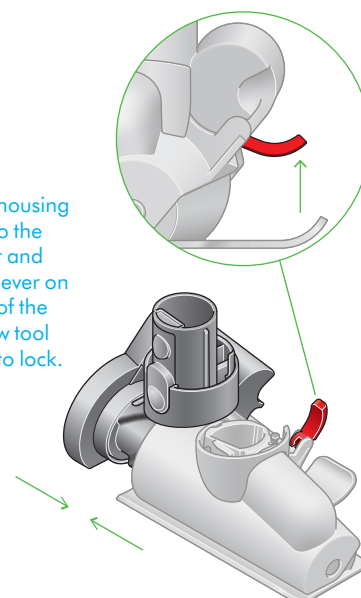

Washing your filter

Wash your filter at least once a month to maintain optimum suction power.

Important: your filter must be completely dry before putting it back into your machine. Your machine could be damaged if used with a damp filter.

For more information and support videos for your machine visit: www.dyson.com/support

Twist off

Twist your filter **anti-clockwise** and pull it away from your machine.

The filter is located at the rear of your machine.

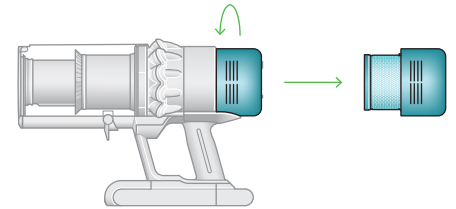

Tap

Before washing your filter, tap it gently over a bin to remove any loose dust and debris.



Holding the filter by the hard, plastic end, tap the other end over the bin.

Wash

Wash the pleated paper element of your filter first, under warm, running tap water, with the foam element facing downwards.

Next, wash the foam element of your filter with the foam element still pointing downwards.

Holding your filter on its side, run warm water over the outside of the foam element, gently rubbing your filter to remove the dirt.

Repeat washing until the water runs clear.

The 'Wash your filter' icon is a blue tap, running water over a filter below.



A tap running water over a filter, signifying rinsing foam from the filter.

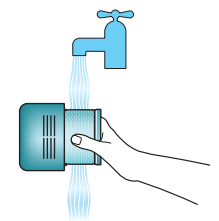
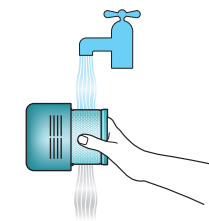

A hand holding the filter with the narrow end pointing downwards with droplets of water being shaken from the filter and again, with the end pointing downwards shaking water out.

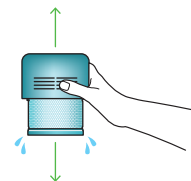

Shake and dry

Empty the filter and shake it firmly to remove excess water.

Keep shaking until there's no water coming from the filter.

Place the filter on its end and leave to dry for at least 24 hours in a well-ventilated, warm place.

After cleaning your filter, thoroughly wash your hands using anti-bacterial soap.

Check that the filter unit is completely dry.

To refit, position the filter unit in place on the main body and twist clockwise until it clicks into place.

Don't dry your filter in a dishwasher, washing machine, tumble dryer, oven, microwave or near a naked flame.

Important: Your filter must be completely dry before you put it back into the machine. Your machine could be damaged if used with a damp filter.

Alert graphic with 24+ reminds you to leave your filter to dry for 24hrs after washing.



The filter is left to dry with the pleated filter end facing downwards.

Washing your Fluffy Optic™ brush bar

Your Fluffy™ Optic cleaner head has a washable brush bar. To maintain optimum performance, check and wash your brush bar regularly.

Make sure your machine is disconnected from the charger and your machine power is turned off.

Don't put any part of your machine in a dishwasher or use detergents, polishes or air fresheners.

Remove your brush bar

Press the cleaner head release button on the end of the wand. Place the cleaner head upside down.

Push the end cap up fully and pull the brush bar out of the cleaner head.

Remove the end cap from the brush bar. Don't wash the end cap.

Slide your brush bar out of the cleaner head.

The end cap is located at the side of the cleaner head. Push this upwards to unlock the brush bar. Don't wash the end cap.

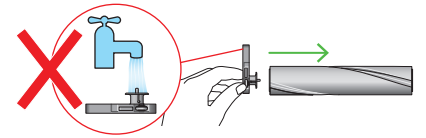
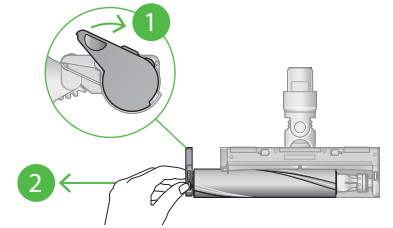

Wash and dry your brush bar

Hold your brush bar under running water and gently rub to remove any lint or dirt.

Stand your brush bar upright as shown. Leave to dry completely for at least 24 hours.

The brush bar has an open end and a closed end. Stand upright, with the closed end facing upwards, to dry.

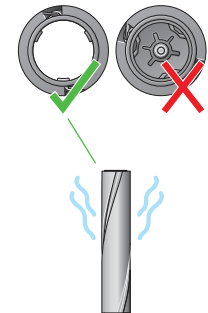

Refit your brush bar

Before refitting, check that your brush bar is completely dry.

Reattach the end cap to your brush bar.

Slide your brush bar into the cleaner head. Push the end cap back down to the closed position.

The end cap should be attached to the cleaner head at an angle less than 90°, any angle greater than this will not allow the end cap to close.

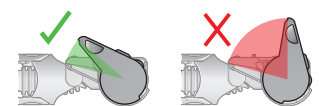
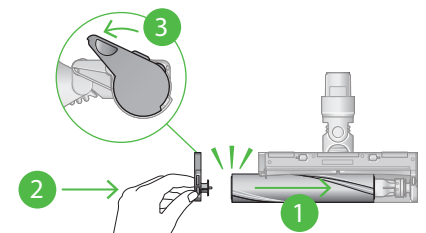

Cleaning your optic lens

To maintain optimum performance, keep your lens clean. Only clean the lens when the cleaner head is not attached to your machine.

Use a soft, dry, lint-free cloth to wipe the lens.

Scratch-free dusting brush

Compatible with Dyson Detect V15™, Dyson Detect Slim V12™, Dyson Outsize™, Dyson V11™, Dyson Cyclone V10™, Dyson V8™, Dyson V7™ and Dyson Digital Slim™ cordless vacuums.

Step 1

Attach the Scratch-free dusting brush directly to your vacuum or to the extension hose for delicate cleaning.

Step 2

Switch on your vacuum with the extension hose, hold the vacuum with one hand and the Scratch-free dusting brush with your other, using a pencil-like grip.

Note: Don't press the Scratch-free dusting brush too hard against surfaces. The ultra-soft bristles should be the only part of the tool that contacts surfaces.



The Scratch-free dusting brush, which has soft dusting bristles at the top and a solid base.

Self-cleaning

Step 1

When you notice dust starting to build up on the bristles during or after use, we recommend you use the built-in self-cleaning function.



The Scratch-free dusting brush has a green arrow, pointing upwards, just above the area of the base that attaches to the vacuum or extension hose.

Step 2

With your vacuum switched on, lift the Cleaning cuff until you hear a click, so it completely covers the bristles. Rotate it five times. This hygienically cleans the dust from the bristles and sucks it into the bin.



A section of the base, has been moved up to cover the bristles completely.

Step 3

After five rotations, move the cleaning cuff back down, until you hear a click. Your bristles are now dust-free.

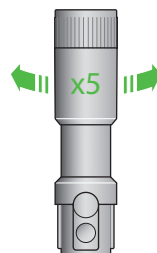

The base of the attachment is still covering the bristles, twist base round 5 times

Note: Only use the self-cleaning function when the Scratch-free dusting brush is attached directly to the vacuum.

Awkward gap tool

Compatible with Dyson Detect V15™, Dyson Detect Slim V12™, Dyson Outsize™, Dyson V11™, Dyson Cyclone V10™, Dyson V8™, Dyson V7™ and Dyson Digital Slim™ cordless vacuums.

Step 1

Attach the Awkward gap tool directly to your vacuum.



A long, thin tool with an angled end.

Step 2

For cleaning standard surfaces, such as skirting boards, use the tool in its original (straight) position.

Step 3

If you are using the tool to reach a tight or awkward gap, rotate the tool to its 22° angle until you hear a click. This allows you to reach further and clean more.

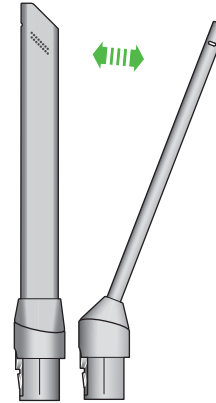

Twist the base of the tool round until you hear a click.

Maintenance tip

To clean, wipe the tool clean with a damp cloth.

Cleaning your tools

Don't put any part of your machine in a dishwasher or use detergents, polishes or air fresheners.

Wipe with a damp, lint-free cloth, without touching the connector end.

Make sure your tools are completely dry before using.



Combination tool



Scratch-free dusting brush



Awkward gap tool



Extension hose



Soft dusting brush



Stubborn dirt brush

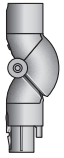

Low-reach adaptor



Light pipe crevice tool



Up-top adaptor

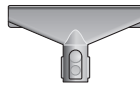

Fabric and mattress tool

Looking after your machine

To always get the best performance from your machine, it's important to clean it regularly and check for blockages.

Look after your machine

If your machine is dusty, wipe with a damp lint-free cloth.

Check for blockages in the cleaner head, tools and main body of your machine.

Wash your filter regularly and leave to dry completely.

Don't use detergents or polishes to clean your machine.

Look after your battery

To get the best performance and life from your battery, use Eco or Auto/Med mode.

Your machine won't operate or charge if the ambient temperature is below 5°C (41°F). This is designed to protect both the motor and battery.

Your serial numbers

You can find your serial numbers on your machine, battery, charger and in your screen settings.

For more information and support for your machine go online:
www.dyson.com/support