

Elicto

Instruction Manual

MODEL NO. ES-530

Instruction Manual

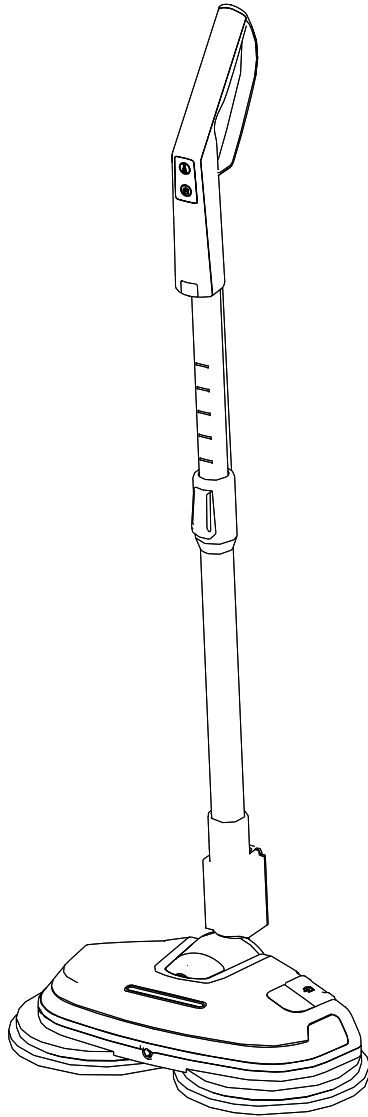

Contents

◆ Safety Attentions.....	3
◆ Name of components and structure.....	7
◆ Item installation methods.....	8
◆ Application instruction.....	8
◆ Correct installation methods of cleaning.....	11
◆ Washing attentions of cleaning pads.....	11
◆ Please confirm before claiming against the problems.....	12
◆ Product specification.....	12

Safety Attentions

In order to avoid the danger and injury, please follow the matters as below:

- Please use the product according to the instruction manual
- This product is only for the inside cleaning, not for other application.

Attentions of the power

Warning The wrong application will cause the injury and death, please follow!

- Power cord, in order to avoid the adanger, please don`t use the product is the power cord is damaged, and please contact.

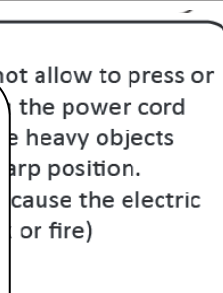
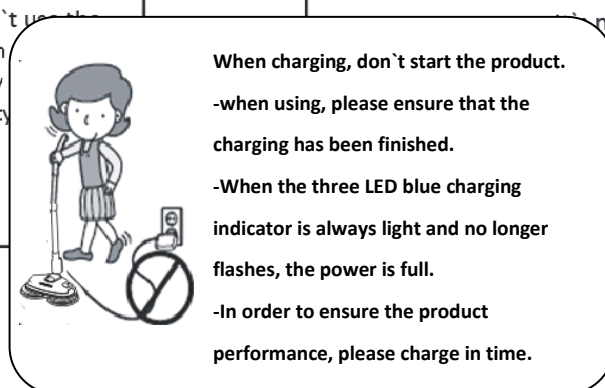
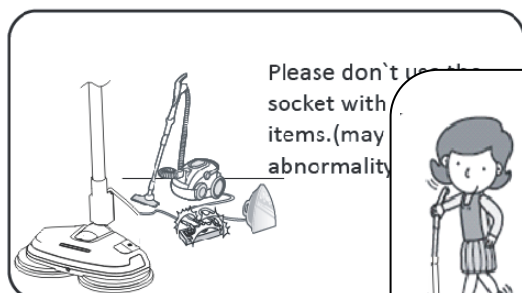
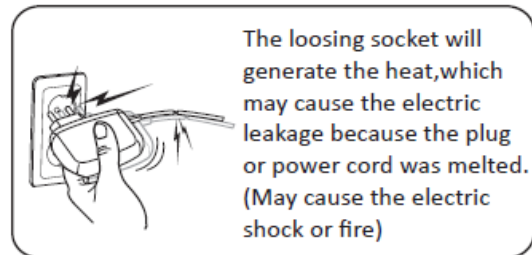
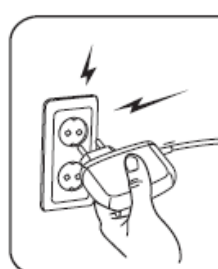
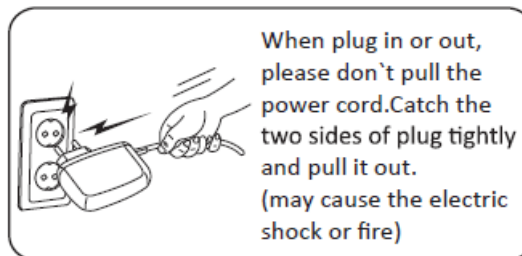
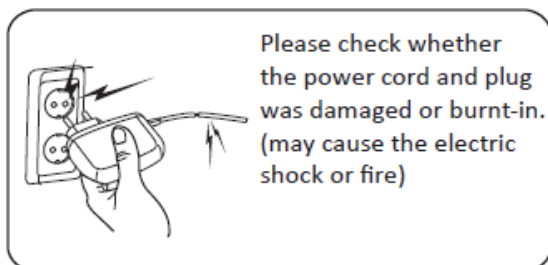

Installation and storage attentions

Warning: The wrong application will cause the injury and death, please follow!

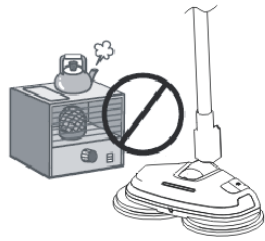

Don't place the equipment of open fire around the mop, such as stove, candles, etc. (The plastic parts or power cord is easily melted, which may cause electric shock or fire)

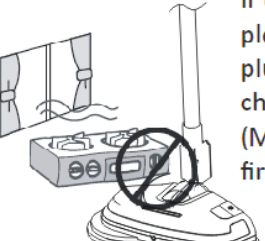

If there is the gas leakage, please don't touch the plug or socket, please change the gas first. (May cause bombing or fire)



Don't allow the children to climb the mop or make it as toys. (The falling of steam mop may hurt the children)



When charging, don't start the product. (may cause barrier)



When storing the product, please keep clean and dry, don't allow the liquid into the product. (May cause the fire or barrier)



Don't uninstall the products except for our technicians (may cause barrier)



Don't place the unit into the canister with water (may cause the fire or electric shock)

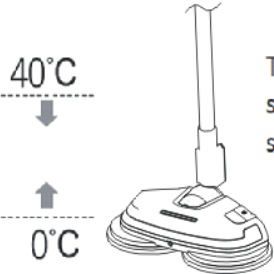

The temperature for storing the product should be 0°C to 40°C

Application Attentions

Warning: The wrong application will cause the injury and death, please follow!



Once the product or cord was damaged, please contact with the after-sale service immediately



Attention, please don't allow the aged or children to operate the product.

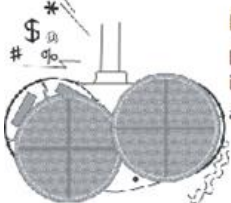

Before using the product, please confirm that the installation of cloth pads are correct.

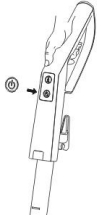

When moving the product, please switch off, and hold the handle to move.



When using the product, please don't jam on the product or shock with heavy objects. (may cause barrier)



When overtime using, the safety protector will start, the machine will stop working, after 2 hours, the product can restart working.



When moving the product, please switch off, and hold the handle to move.

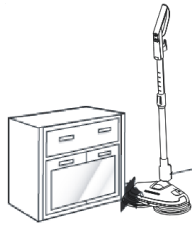

When cleaning, please don't force the mop head into the gaps of furniture, sofa, bed, etc.

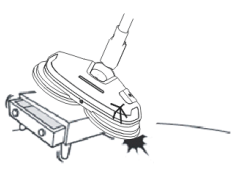

Don't drop the product or shock the product with heavy objects. (may cause barrier)



Please close the switch, When changing the cloth pad.



When found that there is foreign noise, burned smell or smoke, please plug out and contact with the after-sale service. (may cause electric shock or fire, and may reduce the product performance)

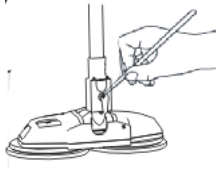

When using the product, please don't use the nail or needle to touch the connectors (may cause electric shock or fire)



Please use the product on the smooth floor inside of home. If the floor is not smooth or there is the foreign objects, please clean first and then use. (may cause the barrier of reduce the product performance)

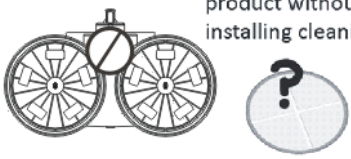

Please don't use the product without installing cleaning pads.

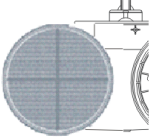

When installing, please install the cloth pads correctly according to the instruction (may cause the abnormal running of bottom plate).

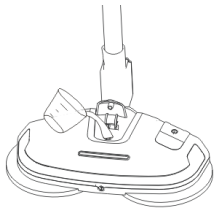

When filling into water, please use the matched measuring cup to avoid more water leaked.



The product is only used for cleaning inside, please don't use for other application.



When using, please don't touch the bottom plate or against the people.



When using, the pets should be far away.



When using, the product should not be close to magnet or metallic products. (may cause the bad performance)

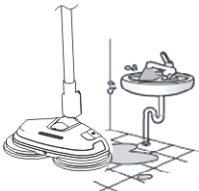

Please don't use under the wet circumstance. (may cause electric shock)

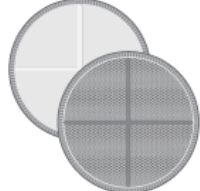

Please use the qualified cloth pads (may cause the poor cleaning efficiency).

- The instructions for appliances with a liquid dispensing system shall specify the amount and type of the liquid to be used.
- The instructions for appliances with rotating brushes shall state that a hazard may occur if the appliance runs over the supply cord.
- The instructions shall state that the plug must be removed from the socket-outlet before cleaning or maintaining the appliance.
- If the supply cord is damaged, it must be replaced by the manufacturer, its service agent or similarly qualified persons in order to avoid a hazard.
- This appliance can be used by children aged from 8 years and above and persons with reduced physical, sensory or mental capabilities or lack of experience and knowledge if they have been given supervision or instruction concerning use of the appliance in a safe way and understand the hazards involved. Children shall not play with the appliance. Cleaning and user maintenance shall not be made by children without supervision.

➤ The instructions for appliances incorporating batteries that are intended to be replaced by the user shall include the following:

- the type reference of the battery;
- the orientation of the battery with regard to polarity;
- the method of replacing batteries;
- details regarding safe disposal of used batteries;
- warning against using non-rechargeable batteries;
- how to deal with leaking batteries.

➤ The instructions for appliances incorporating a battery that contains materials that are hazardous

- to the environment shall give details on how to remove the battery and shall state that
- the battery must be removed from the appliance before it is scrapped.
 - the appliance must be disconnected from the supply mains when removing the battery.
 - the battery is to be disposed of safely.

Name of components and structure

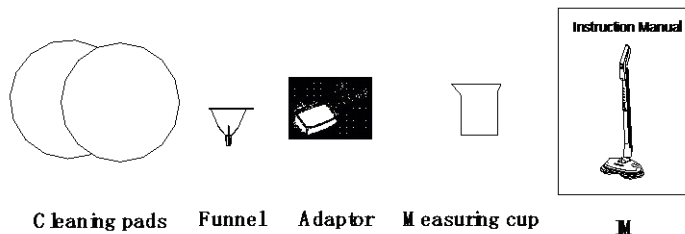
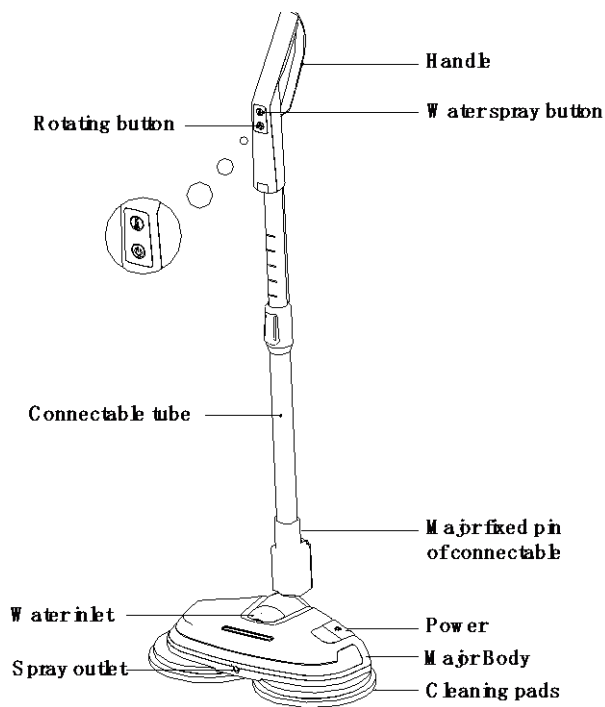

Item installation methods

- **When installing, please connect with power, may cause the product barrier or electric shock.**

1. Please take the handle and the major body from the packing box.

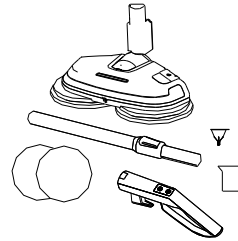

2. Slide the bottom end of Telescopic pipe onto the polisher head until pipe button clicks into place. When fixing well, you will hear "clicking" sound, After connecting, please pull tightly to ensure Whether the installation is good.

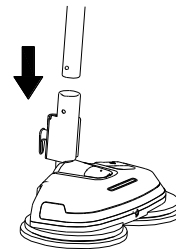

3. -Open the battery cover in the back part of handle, put in 2*3AAA, 1.5v battery, close the battery cover.
-Connect handle with telescopic pipe, Insert handle into pipe until pipe button clicks into place. When fixing well, you will hear "clicking" sound, After connecting, please pull tightly to ensure Whether the installation is good.

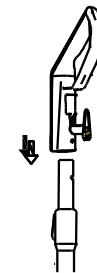

Application Instruction

- **Please follow the below instruction**

1. When cleaning, please absorb the Water completely, and then twist all water out.

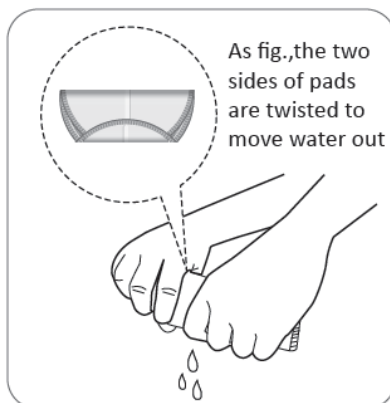

2. Fix the cloth pads on rotating plates.

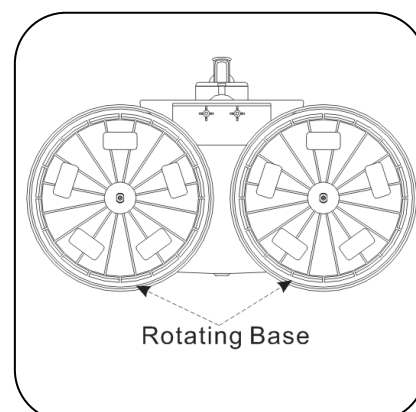

3. When the center of pads and rotating plate match well, fix the pads

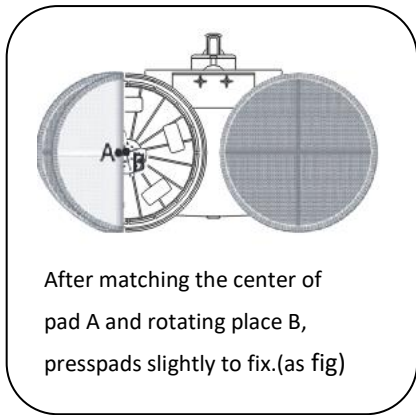

4. Before cleaning, please confirm there is no foreign objects on the floor.(the foreign objects may cause the barrier or accidents of product.)

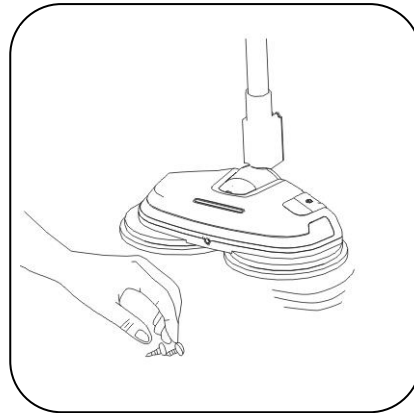

5. Connecting power, step the button on the main body, LED will be bright.

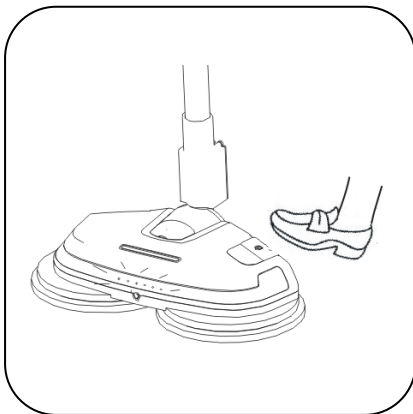

6. Hold the handle, press the button. (The battery must be inserted into the handle)

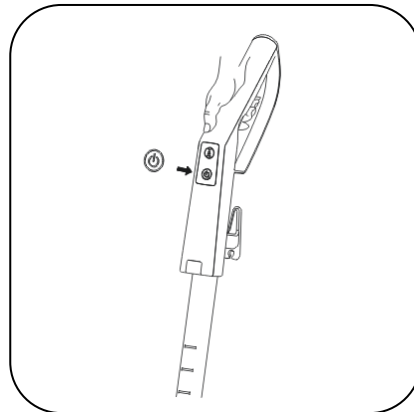

7. When using, press the water spray button for water spraying.(with full water inside)

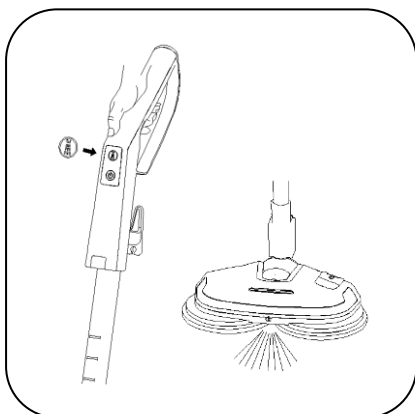

8. When there is no water spraying out, please power off and refill into water.

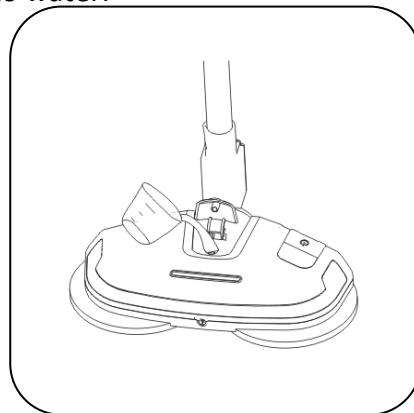

9. Please use the adaptor of this product for charging (The charging time is around 3 hours, When the three LED blue charging indicator is always light and no longer flashes, the power is full.)

Relevant safety attentions

For your safety, please follow the attentions as below

- Once the batter has the visible bulging problem that is very dangerous, please contact with the manufacturer or distributor immediately.
- Please use the correct and pointed adaptor for charging.
- Please don't be close to fire or flammable objects(Don't put into microwave oven)
- Please don't put into the cars in summer.
- Please don't use or store at the places of high temperature, such as Sauna room.
- Please don't touch the connector of battery with coin, necklace, keys, etc.
- Please use the NI-MH Battery that is pointed by the manufacturer.
- Please don't uninstall, press, beat, etc.
- Please don't do the unnormal colliding action, such as falling down from the high places.
- Please don't put into the high temperature above 60°C.

- (avoid the direct sunshine)
- should be far from the wet.
- If the battery has leakage, don't touch the skin with liquid. If touched carelessly, please clean with water and see the doctor.
- Please recognize the correct using of two electric poles(+)(-).
- Please keep the battery far from the places that the children can reach.
- If swallowed the battery, please see the doctor immediately.
- If stored the battery separately, please put it at the dry and clean place.
- Please clean the dirty on the battery with clean and dry cloth.
- Please follow the correct instruction of manufacturer for charging.
- After long time storage, in order to achieve at the best performance, please charge and discharge repeatedly for several times.

- When using the battery under the normal temperature ($20\pm 5^{\circ}\text{C}$), the performance is the best.
- Please use the battery correctly according to its application.
- Please handle the scrapped battery correctly.

Correct installation of cloth pads

- The cloth pads and the rotating plate should be pasted well.
- The center of pads and rotating plate should match well.

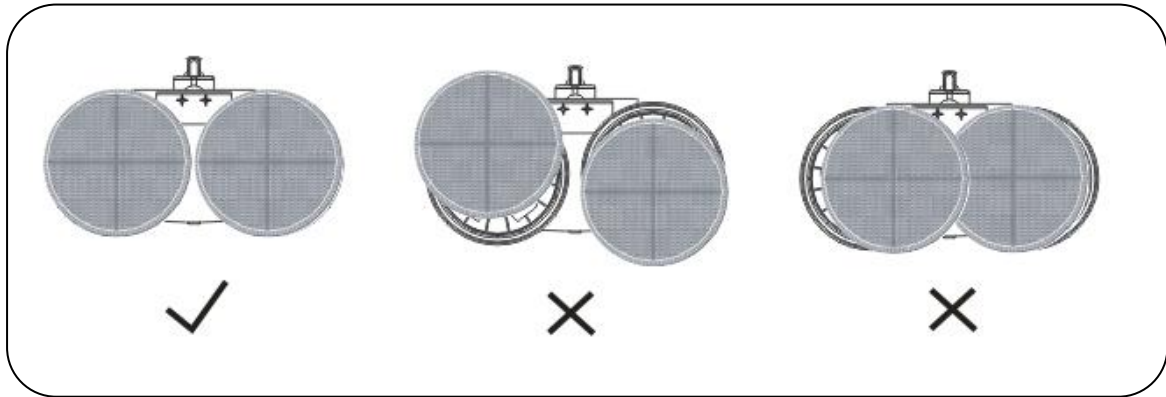

Washing attentions of cleaning pads

① When machine washing ,please absorb some detergent for washing



After soaking in 40°C water, put in moderate detergent and washing



① After using pads,please wash and dry

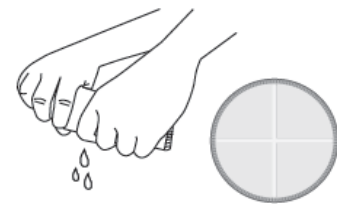

When washing,please remove the foreign objects left on the pads to avoid the damage against the floor.

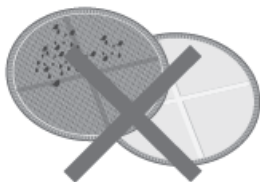

When washing,considering the absorption of water,sanitation and pad structure,suggest to wash alone.



Don't use the bleaching agent, softener,etc.



Please confirm before cleaning against the problems

- When using the products, there is the after-sale claims without any problems. Please confirm the below subjects.
- Which can solve the simple problems and confirm whether these is the real problems, also can reduce the unnecessary troubles.

Barriers' Appearances	Confirmed subjects
Can't start	<ul style="list-style-type: none"> - Please ensure whether the product has been charged - please ensure whether the switch has been started. - Please ensure whether the hand of product has the battery and the battery capacity enough. -The normal running time us 20 minutes, there will be the difference for different environment. -Please ensure whether the product is overtime used, After 2 hours, please restart.
Much water left on floor	Please ensure whether the pads are wet
The machine body shocks seriously	Please ensure whether the pads are installed well
There is the foreign noise when cleaning	<ul style="list-style-type: none"> -there is the light "buzz" noise, which is normal. -Please ensure whether the is foreign objects.