

Robot[®]

Roomba[®]

Clean Base™ Automatic Dirt Disposal

For Roomba® i Series Robot Vacuums

Owner's Guide

Safety Information

Important Safety Information

This owner's guide includes information for Regulatory Model(s): ADE-N1 and ADE-N2.

SAVE THESE INSTRUCTIONS

⚠ WARNING: When using an electrical appliance, basic precautions should always be followed, including the following:











READ ALL INSTRUCTIONS

⚠ WARNING: To reduce the risk of injury or damage, read and follow the safety precautions when setting up, using and maintaining your robot.

This appliance can be used by children aged from 8 years and above and persons with reduced physical, sensory or mental capabilities or lack of experience and knowledge if they have been given supervision or instruction concerning use of the appliance in a safe way and understand the hazards involved. Children shall not play with the appliance. Cleaning and user maintenance shall not be made by children without supervision.

⚠ WARNING: Cancer and Reproductive Harm – www.P65Warnings.ca.gov/product

⚠ This is the safety alert symbol. It is used to alert you to potential physical injury hazards. Obey all safety messages that follow this symbol to avoid possible injury or death.

- | | | | | |
|--|---|--|---|--|
|  Risk of electric shock |  Class II equipment |  Rated power output, d.c. |  Read operator's manual |  General symbol for recycling |
|  Risk of fire |  For indoor use only |  Rated power input, d.c. |  Keep out of reach of children | BFP Backfeed Protection |
|  Separate Supply Unit |  Rated power input, a.c. | | | |

WARNING: Indicates a hazardous situation that, if not avoided, could result in death or serious injury.

CAUTION: Indicates a hazardous situation that, if not avoided, could result in minor or moderate injury.

NOTICE: Indicates a hazardous situation that, if not avoided, could result in property damage.

GENERAL



WARNING

- This product is not a toy. Small children and pets should be supervised when the product is operating.
- Do not sit or stand on this product.
- This product comes with a region approved power supply cord and is designed to be plugged into a standard household AC power outlet only. Do not use any other power supply cord. For replacement cords, please contact Customer Care to ensure proper selection of country specific power supply cord.
- Do not disassemble or open the dirt disposal unless instructed to do so. There are no user serviceable parts inside. Refer servicing to qualified service personnel.
- Risk of electric shock, use indoors in dry location only.
- Do not handle this product with wet hands.
- Store and operate this product in room temperature environments only.

AUTOMATIC DIRT DISPOSAL



WARNING

- To reduce the risk of electric shock, unplug your dirt disposal before cleaning.

- Do not pour any liquids into the device and do not immerse in water.
- Do not use outdoors or on wet surfaces.
- Do not allow to be used as a toy. Close attention is necessary when used by or near children.
- Use only as described in this manual.
- Do not use with damaged cord or plug. If appliance is not working as it should, has been dropped, damaged, left outdoors, or dropped into water, return it to a service center.
- Do not handle plug or appliance with wet hands.
- Do not put any object into openings. Do not use with any opening blocked; keep free of dust, lint, hair, and anything that may reduce air flow.
- In order to avoid a hazard due to inadvertent resetting of the thermal cut-out, this appliance must not be supplied through an external switching device, such as a timer, or connected to a circuit that is regularly switched on and off by the utility.

NOTICE

- Product may not be used with any type of power converter. Use of power converters will immediately void the warranty.
- If you live in an area prone to electrical storms, it is recommended that you use additional surge protection. Your dirt disposal may be protected with a surge protector in the event of severe electrical storms.
- Do not use without dust bag and/or filters in place.
- To properly maintain your dirt disposal, do not place foreign objects inside and ensure it is clear of debris.
- Always disconnect your robot from the dirt disposal before cleaning or maintaining it.

About Your Clean Base™ Automatic Dirt Disposal

Front View

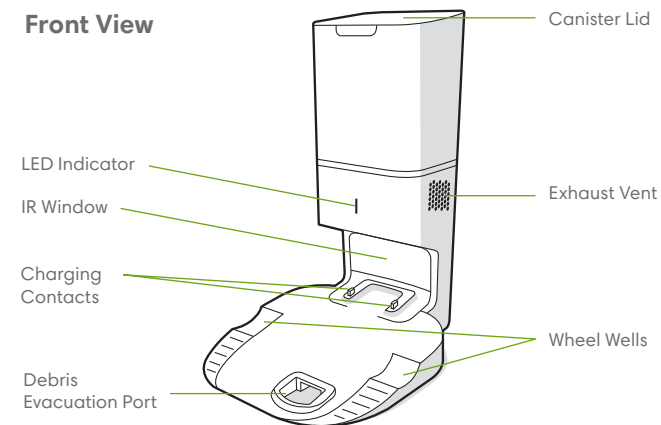

Top View

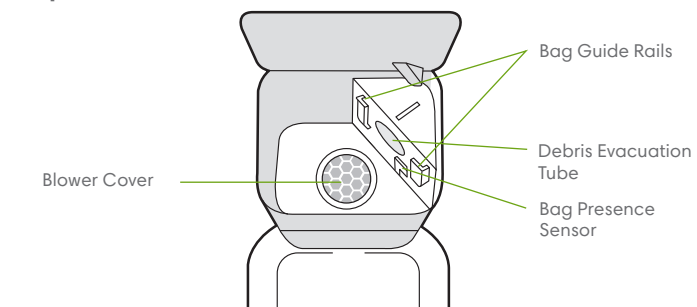

Back View

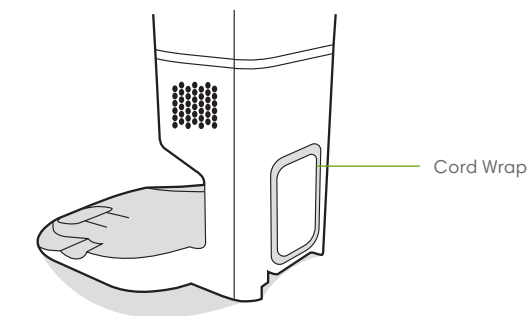

Bottom View

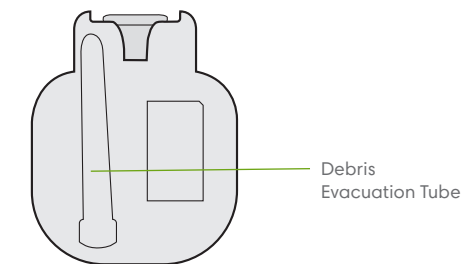

Using Your Automatic Dirt Disposal

Positioning the Clean Base™ Automatic Dirt Disposal

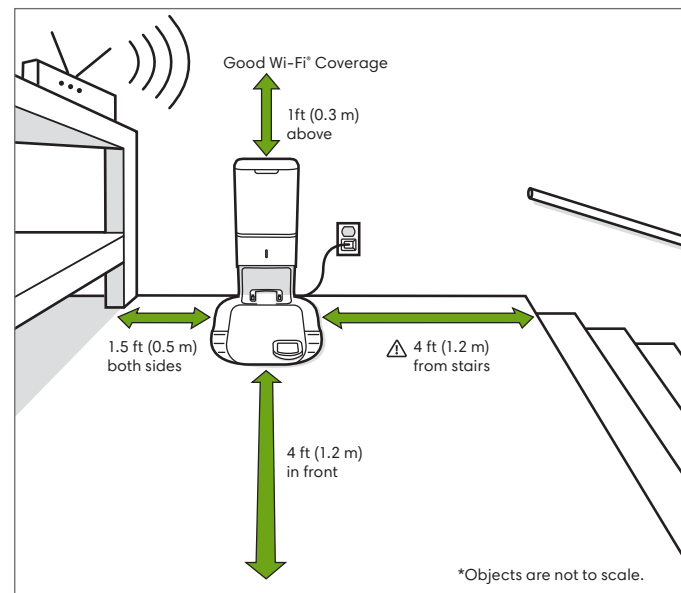

⚠ WARNING: To prevent the risk of your robot falling downstairs, ensure that the charging station is placed at least 4 feet (1.2 meters) away from stairs.

About Your Automatic Dirt Disposal

While cleaning, your robot will automatically return to the dirt disposal to empty its bin and recharge as needed.

The dirt disposal's LED indicator will turn solid red when a new bag is needed. If a clog is detected, the dirt disposal will trigger additional attempts to automatically clear the clog.

Note: If you place your robot on the dirt disposal by hand, it will not empty automatically. In this case, use the iRobot HOME App or the button on your robot to manually empty your robot's bin.

Care and Maintenance

Care and Maintenance Instructions

To keep your dirt disposal running at peak performance, follow these care procedures:

Dock Part	Care Frequency	Replacement frequency
Bags	-	Bags should be replaced when prompted by the LED indicator / app
Charging Contacts	Once every month	-
IR Window		
Blower Cover inside canister	Once every month (remove debris from blower cover)	-

Note: iRobot manufactures various replacement parts and assemblies. If you think you need a replacement part, please contact iRobot Customer Care for more information.

Replacing the Bag

1 Lift up on the canister lid to open.

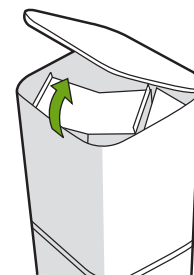

2 Pull up on the plastic card to remove the bag from the canister.

Note: This will seal the bag so dust and debris cannot escape.



3 Discard the used bag.

4 Install a new bag, sliding the plastic card into the guide rails.

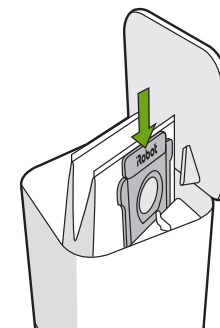

5 Press down on the lid making sure it is completely closed.

Note: To achieve optimal performance with your robot and automatic dirt disposal, clean and/or replace your robot's filter as needed.

Cleaning the IR Window and Charging Contacts

Inspect the sensors and charging contacts to make sure they are clear of debris. Wipe with a clean, dry cloth.

Note: Do not spray cleaning solution directly onto sensors or into sensor openings.

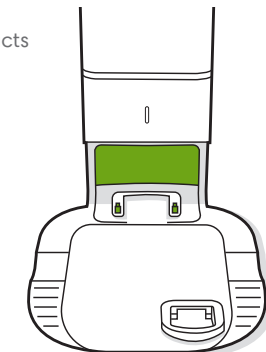

Removing Debris from Blower Cover

Inspect blower cover for any lint or debris built-up, and wipe with a clean dry cloth to remove.

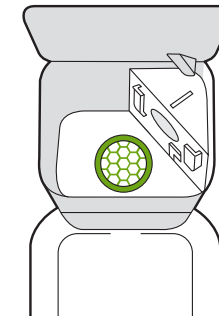

Troubleshooting

Your dirt disposal will tell you if something is wrong via an LED indicator on the front of the canister and through the iRobot HOME App.

LED Indicator	Common Error	How to Fix
Solid Red	Bag full or missing	<ol style="list-style-type: none"> 1. Replace bag if it is full or missing. 2. Make sure the bag is securely inserted. 3. If problem persists, remove any debris from the port on the bottom of your robot and the dirt disposal.
Blinking Red	There is a leak or a clog in the dock evacuation path	<ol style="list-style-type: none"> 1. Make sure the canister lid is pushed down and firmly sealed. Tap the  button on your robot to manually empty the bin. 2. Remove any debris from the port on the bottom of your robot and dirt disposal. 3. Unplug the dirt disposal from the wall. Place it on its side and inspect the debris evacuation tube for debris. If necessary, remove the tube to clear any debris.

iRobot Customer Care

USA & Canada

If you have questions or comments about your dirt disposal, please contact iRobot before contacting a retailer.

You can start by visiting global.irobot.com for support tips, frequently asked questions and information about accessories. This information can also be found in the iRobot HOME App. If you need further assistance, call the US Customer Care team at **(877) 855-8593**.

iRobot USA Customer Care Hours

- Monday to Friday, 9AM – 9PM Eastern Time
- Saturday and Sunday 9AM – 6PM Eastern Time

Outside USA & Canada

Visit global.irobot.com to:

- Learn more about iRobot in your country
- Get hints and tips to improve your product performance
- Get answers to questions
- Contact your local support center

Regulatory Information

This device complies with part 15 of the FCC Rules and ICES-003. Operation is subject to the following two conditions: 1) This device may not cause harmful interference, and 2) this device must accept any interference received, including interference that may cause undesired operation.

This device complies with Industry Canada license-exempt RSS standard(s). Operation is subject to the following two conditions: 1) This device may not cause interference, and 2) this device must accept any interference, including interference that may cause undesired operation of the device.

- Changes or modifications not expressly approved by iRobot Corporation could void the user's authority to operate the equipment.
- This equipment has been tested and found to comply with the limits for a Class B digital device, pursuant to part 15 of the FCC Rules as well as ICES-003 Rules. These limits are designed to provide reasonable protection against harmful interference in a residential installation. This equipment generates, uses and can radiate radio frequency energy and, if not installed and used in accordance with the instructions, may cause harmful interference to radio communications. However, there is no guarantee that interference to radio communication will not occur in a particular installation. If this equipment does cause harmful interference to radio or television reception, which can be determined by turning the equipment off and on, the user is encouraged to try to correct the interference by one or more of the following measures:
 - Reorient or relocate the receiving antenna.
 - Increase the separation between the equipment and receiver.

- Connect the equipment into an outlet on a circuit different from that to which the receiver is connected.
- Consult the dealer or an experienced radio/TV technician for help.
- Under Industry Canada regulations, this radio transmitter may only operate using an antenna of a type and maximum (or lesser) gain approved for the transmitter by Industry Canada. To reduce potential radio interference to other users, the antenna type and its gain should be so chosen that the equivalent isotropically radiated power (e.i.r.p.) is not more than the necessary for successful communication.
- FCC Radiation Exposure Statement: This product complies with FCC §2.1093(b) for portable RF exposure limits, set forth for an uncontrolled environment and is safe for the intended operation as described in this manual.
- ISED Radiation Exposure Statement: This product complies with the Canadian Standard RSS-102 for portable RF exposure limits, set forth for an uncontrolled environment and is safe for the intended operation as described in this manual.





©2018 iRobot Corporation, 8 Crosby Drive, Bedford, MA 01730 USA. All rights reserved.
iRobot, Roomba, and Virtual Wall are registered trademarks of iRobot Corporation.
HomeBase+ is a trademark of iRobot Corporation. Wi-Fi and the Wi-Fi logo are
registered trademarks of Wi-Fi Alliance.

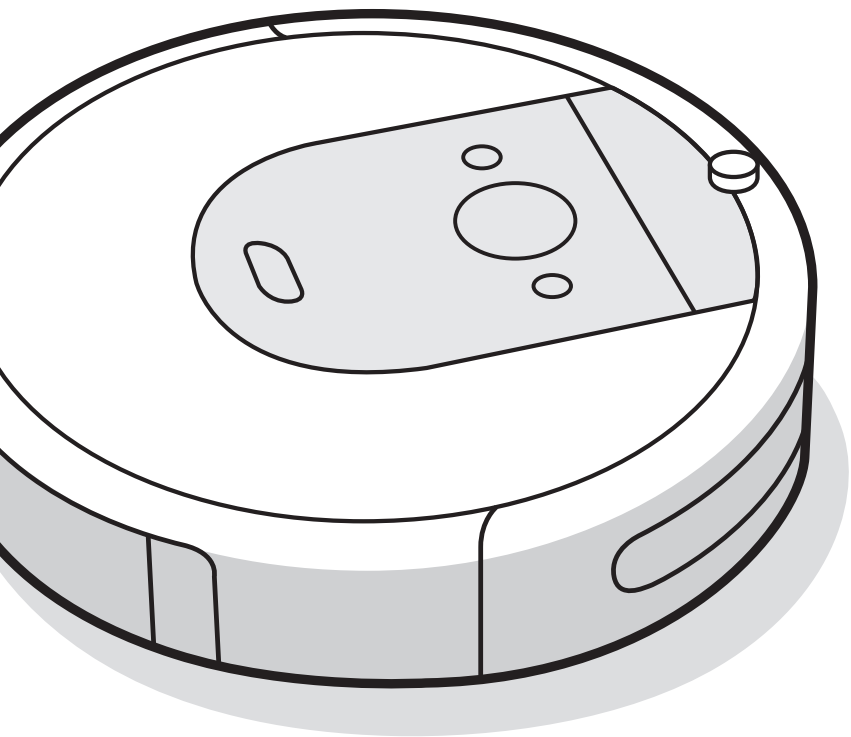

Robot[®]

Roomba[®]
Robot Vacuum

i Series
Owner's Guide

Safety Information

Important Safety Information

This owner's guide includes information for Regulatory Model(s): RVB-Y1

SAVE THESE INSTRUCTIONS

⚠ WARNING: When using an electrical appliance, basic precautions should always be followed, including the following:











READ ALL INSTRUCTIONS

⚠ WARNING: To reduce the risk of injury or damage, read and follow the safety precautions when setting up, using and maintaining your robot.

This appliance can be used by children aged from 8 years and above and persons with reduced physical, sensory or mental capabilities or lack of experience and knowledge if they have been given supervision or instruction concerning use of the appliance in a safe way and understand the hazards involved. Children shall not play with the appliance. Cleaning and user maintenance shall not be made by children without supervision.

⚠ WARNING: Cancer and Reproductive Harm – www.P65Warnings.ca.gov/product

⚠ This is the safety alert symbol. It is used to alert you to potential physical injury hazards. Obey all safety messages that follow this symbol to avoid possible injury or death.

- | | | | | |
|--|---|--|---|--|
|  Risk of electric shock |  Class II equipment |  Rated power output, d.c. |  Read operator's manual |  General symbol for recycling |
|  Risk of fire |  For indoor use only |  Rated power input, d.c. |  Keep out of reach of children | BFP Backfeed Protection |
|  Separate Supply Unit |  Rated power input, a.c. | | | |

WARNING: Indicates a hazardous situation that, if not avoided, could result in death or serious injury.

CAUTION: Indicates a hazardous situation that, if not avoided, could result in minor or moderate injury.

NOTICE: Indicates a hazardous situation that, if not avoided, could result in property damage.

GENERAL



WARNING

- Your robot is not a toy. Small children and pets should be supervised when your robot is operating.
- Do not sit or stand on your robot or charging station.
- Do not use unauthorized chargers. Use of an unauthorized charger could cause the battery to generate heat, smoke, catch fire, or explode.
- Your robot comes with a region approved power supply cord and is designed to be plugged into a standard household AC power outlet only. Do not use any other power supply cord. For replacement cords, please contact Customer Care to ensure proper selection of country specific power supply cord.
- Do not open your robot or charging station. There are no user serviceable parts inside. Refer servicing to qualified service personnel.
- Risk of electric shock, use indoors in dry location only.
- Do not handle your robot or charging station with wet hands.
- Store and operate your robot in room temperature environments only.
- If the room to be cleaned contains a balcony, a physical barrier should be used to prevent access to the balcony and ensure safe operation.



CAUTION

- Do not operate the robot in areas with exposed electrical outlets in the floor.
- If the device passes over a power cord and drags it, there is a chance an object could be pulled off a table or shelf. Before using this device, pick up objects like clothing, loose papers, pull cords for blinds or curtains, power cords, and any fragile objects.
- Be aware that the robot moves on its own. Take care when walking in the area that the robot is operating in to avoid stepping on it.
- Do not use this device to pick up sharp objects, glass, or anything that is burning or smoking.

NOTICE

- This robot is intended for dry floor use only. Do not use this device to pick up spills. Do not allow your robot or charging station to become wet.
- Do not place anything on top of your robot.
- The failure to maintain cleanliness of charger contacts could result in loss of ability for the robot to charge the battery.

CHARGING STATION



WARNING

- Do not use a charging station with a damaged cord or plug if the cord or plug is damaged, it must be replaced.
- Always disconnect your robot from the charging station before cleaning or maintaining it.

- Charge your robot only with the power supply provided. The provided power supply delivers safety extra low voltage corresponding to the input marking on the robot which is required to maintain safe operation.
- To prevent the risk of your robot falling downstairs, ensure that the charging station is placed at least 4 feet (1.2 meters) away from stairs.

NOTICE

- Product may not be used with any type of power converter. Use of power converters will immediately void the warranty.
- If you live in an area prone to electrical storms, it is recommended that you use additional surge protection. Your charging station may be protected with a surge protector in the event of severe electrical storms.

BATTERY



WARNING

- Do not open, crush, heat above 176°F: 80°C, or incinerate. Follow manufacturer's instructions.
- Do not short-circuit the battery by allowing metal objects to contact battery terminals or immerse in liquid. Do not subject batteries to mechanical shock.
- Periodically inspect the battery pack for any sign of damage or leakage. Do not charge damaged or leaking battery packs, do not allow the liquid to come in contact with skin or eyes. If contact has been made, wash the affected area with copious amounts of water and seek medical advice. Place the battery in a sealed plastic bag and recycle or dispose of safely

according to local environmental regulations, or return it to your local authorized iRobot Service Center for disposal.



CAUTION

- Battery usage by children should be supervised. Seek medical advice immediately if a cell or a battery has been swallowed.

NOTICE

- The battery pack must be removed from the robot before recycling or disposal.
- For best results, only use the iRobot Lithium Ion Battery that comes with the robot.
- Do not use non-rechargeable batteries. Use only the rechargeable battery supplied with the product. For replacement, purchase identical iRobot battery or contact iRobot Customer Care for alternative battery options.
- Always charge and remove the battery from your robot and accessories before long-term storage.

Note: For battery recycling go to call2recycle.org; or call 1-800-822-8837

About your Roomba® Robot Vacuum

Top View

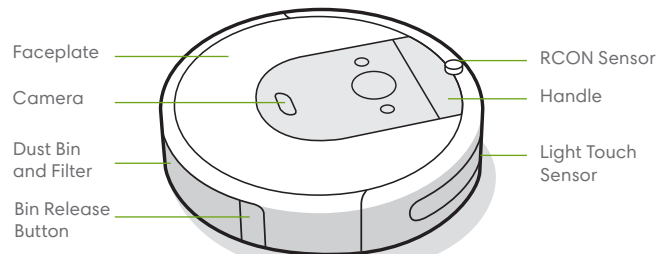

Home Base™ Charging Station

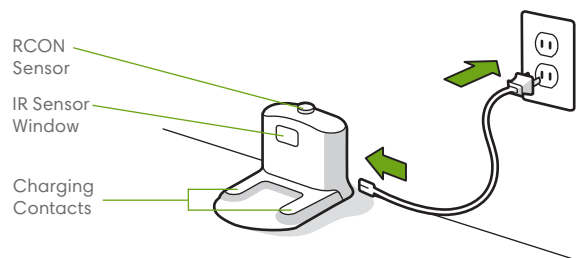

Bottom View

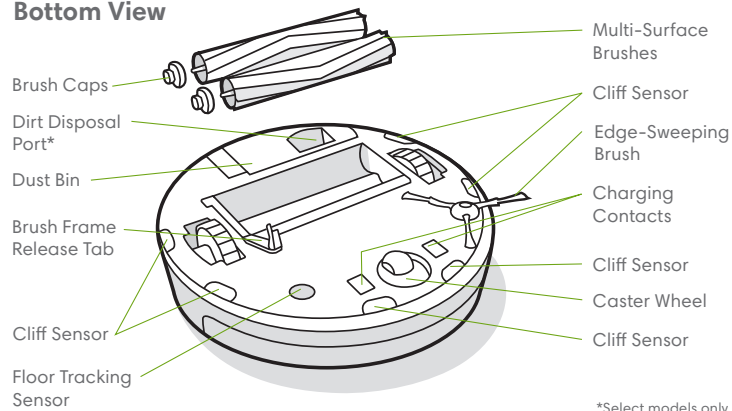

Buttons & Indicators

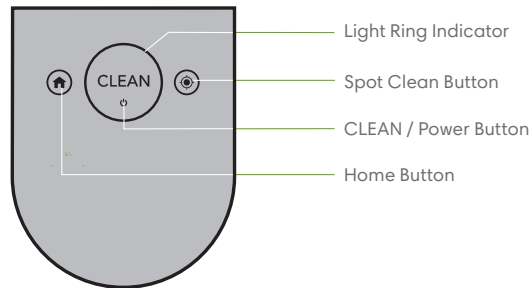

*Select models only

Using Your Roomba® Robot Vacuum

Positioning the Home Base™ Charging Station

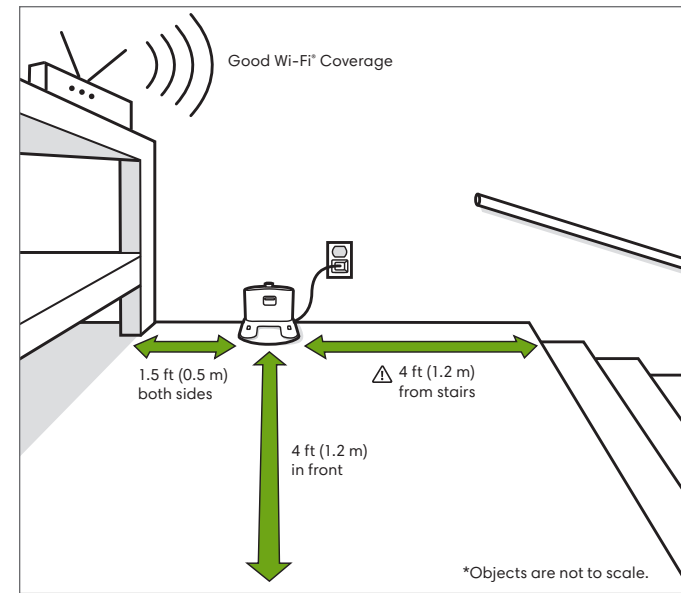

WARNING: To prevent the risk of your robot falling downstairs, ensure that the charging station is placed at least 4 feet (1.2 meters) away from stairs.

Charging



White Light Ring While Charging
 Solid White: fully charged
 Pulsing White: charging
 Turns off after 1 minute to save power

- Place the robot on the charging station to activate the battery.
- Note:** Your robot comes with a partial charge, but we recommend that you charge the robot for 3 hours prior to starting the first cleaning job.
- If the "CLEAN" text is pulsing while charging, the robot is in the middle of a cleaning job and will automatically resume where it left off once recharged.
- The robot uses a small amount of power whenever it is on the charging station. You can put the robot in a further-reduced power state when not in use. For instructions and more details on this Reduced Power Standby Mode, refer to the iRobot HOME App.
- For long-term storage, turn off the robot by removing it from the charging station and holding down  for 10 seconds. Store the robot in a cool, dry place.

Cleaning



Remove excess clutter from floors before cleaning. Use your robot frequently to maintain well-conditioned floors.

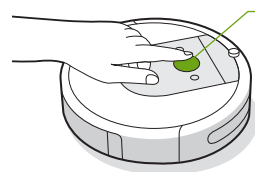

Just Press CLEAN

Tap to Start / Pause / Resume

Hold for 3 seconds to end a job

- Your robot will automatically explore and clean your home. It will return to the charging station at the end of a cleaning job and whenever it needs to recharge.
- To send the robot back to its charging station, tap . A blue light ring pattern will indicate that the robot is seeking the charging station.
- When your robot detects an especially dirty area, it will engage Dirt Detect™ mode, moving in a forward/backward motion to clean the area more thoroughly. The light ring indicator will flash blue.
- Tap to spot clean a designated area. The robot will spiral outward about 3 feet (1 meter) and then spiral inward to end where it started. The light ring indicator will show a blue spiral.



When the robot senses its bin needs to be emptied, the light ring indicator will illuminate in a red sweeping motion toward the rear.

Troubleshooting

- Your robot will tell you something is wrong by playing an audio alert and turning the light ring indicator red. Press CLEAN or tap the bumper for details. Further support and instructional videos are available in the iRobot HOME App.

Red Light Ring

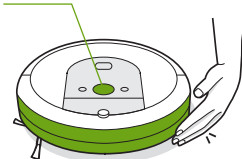

Low battery. Please charge.

- After 90 minutes of inactivity off the charging station, the robot will automatically end its cleaning job.

Battery Safety & Shipping

For best results, only use the iRobot Lithium Ion Battery that comes with your robot.



WARNING: Lithium ion batteries and products that contain lithium ion batteries are subject to stringent transportation regulations. If you need to ship this product for service, travel or any other reason, you MUST follow the below shipping instructions.

- Battery MUST be turned off before shipping.
- Turn off the battery by removing the robot from the charging station and holding down for 10 seconds. All indicators will turn off.
- Package the robot securely for shipping.
- If you need further assistance, contact our Customer Care team or visit global.irobot.com.

Accessories

Dual Mode Virtual Wall® Barrier

Note: For best results, place at least 8 feet (2.5 meters) from the charging station.

Use the Dual Mode Virtual Wall® barrier to keep the robot in the places you want cleaned — and out of the ones you don't. It creates an invisible barrier that only the robot can see. You can leave the device in position between cleanings.

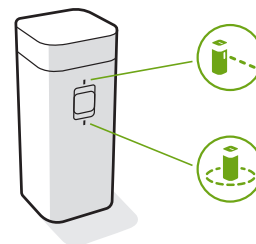

Choose the mode to meet your needs:

Virtual Wall Mode: When the switch is in the Virtual Wall position (), the device will create a linear barrier to block openings up to 10 feet (3 meters).

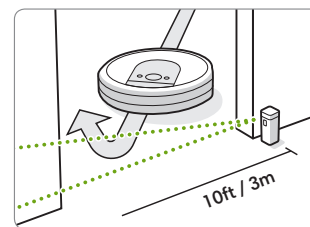

Note: This barrier gets wider as it gets further from the device (refer to illustration).

Halo Mode: Toggle the switch to the Halo position (), to create a circular barrier. This will prevent the robot from approaching zones you want to protect such as a pet bowl, vase, or under a desk. The Halo barrier extends approximately 24 inches (60 centimeters) from the center of the device.

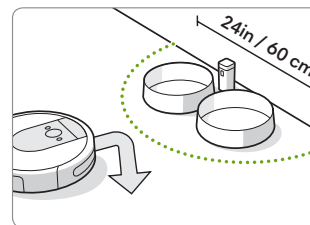

Note: The batteries will last about 8-10 months under normal use. If you are not planning to use your Virtual Wall barrier for an extended period of time, be sure to turn the switch to the Off, or middle position.

Care and Maintenance

Care and Maintenance Instructions

To keep your robot running at peak performance, perform the procedures on the following pages.

There are additional instructional videos in the iRobot HOME App. If you notice the robot picking up less debris from your floor, empty the bin, clean the filter and clean the brushes.

Part	Care Frequency	Replacement Frequency*
Bin	Wash bin as needed	
Filter	Clean once a week (twice a week if you have a pet). Do not wash.	Every 2 months
Full Bin Sensor	Clean every 2 weeks	
Front Caster Wheel	Clean every 2 weeks	Every 12 months
Edge-Sweeping Brush and Multi-Surface Brushes	Clean once a month (twice a month if you have a pet)	Every 12 months
Sensors and Charging Contacts	Clean once a month	

Note: iRobot manufactures various replacement parts and assemblies. If you think you need a replacement part, please contact iRobot Customer Care for more information.

*Replacement frequency may vary. Parts should be replaced if visible wear appears.

Emptying the Bin

- 1 Press bin release button to remove bin.

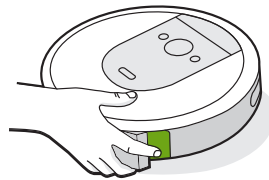

- 2 Open bin door to empty bin.

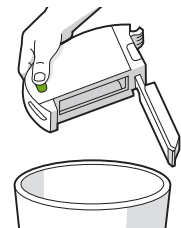

- 3 Place bin back in the robot.



Cleaning the Filter

- 1 Remove the bin. Remove the filter by grasping both ends and pulling out.

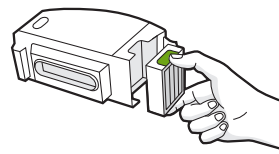

- 2 Remove debris by tapping the filter against your trash container.



- 3 Reinsert filter with ridged grips facing out. Place bin back in the robot.

Important: The robot will not run if the filter is not installed correctly. Replace the filter every two months.

Cleaning the Full Bin Sensors

- 1 Remove and empty the bin.

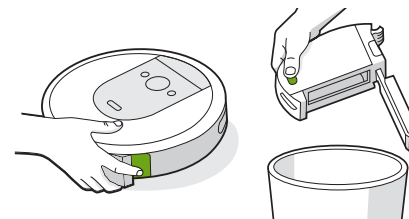

- 2 Wipe the inner sensors with a clean, dry cloth.

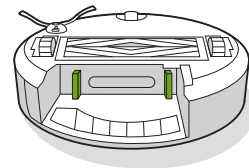

- 3 Wipe the bin door with a clean, dry cloth.

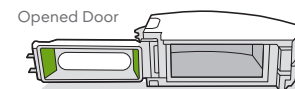

Washing the Bin

Important: Do not wash the filter. Remove the filter before washing the bin.

- 1 Release the bin, remove the filter, and open the bin door.
- 2 Rinse the bin using warm water.

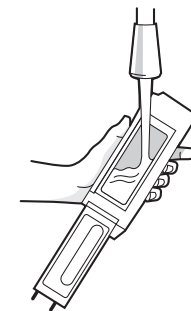

Note: Bin is not dishwasher safe.

- 3 Make sure bin is completely dry. Reinsert filter and place bin back in the robot.

Cleaning the Edge-Sweeping Brush

- 1 Use a coin or small screwdriver to remove the screw holding the Edge-Sweeping Brush in place.
- 2 Pull to remove the Edge-Sweeping Brush. Remove any hair or debris, then reinstall the brush.

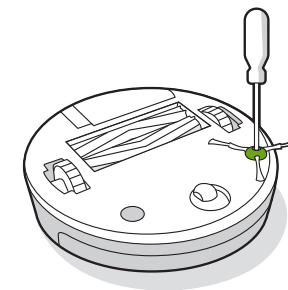

Cleaning the Front Caster Wheel

- 1 Pull firmly on the front wheel module to remove it from the robot.
- 2 Pull firmly on the wheel to remove it from its housing (see illustration below).
- 3 Remove any debris from inside the wheel cavity.
- 4 Reinstall all parts when finished. Make sure the wheel clicks back into place.

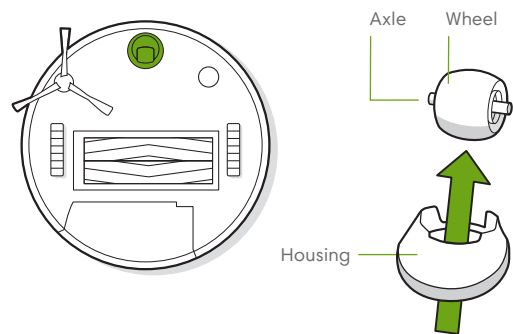

*** Important:** A front wheel clogged with hair and debris could result in damage to your floor. If the wheel is not spinning freely after you have cleaned it, please contact Customer Care.

Cleaning the Multi-Surface Brushes

- 1 Pinch the brush frame release tab, lift the tab, and remove any obstructions.
- 2 Remove the brushes from the robot. Remove the brush caps from the ends of the brushes. Remove any hair or debris that has collected beneath the caps. Reinstall the brush caps.
- 3 Remove any hair or debris from the square and hexagonal pegs on the opposite side of the brushes.
- 4 Remove the bin from the robot and clear any debris from the vacuum path.

- 5 Reinstall the brushes in the robot. Match the shape of the brush pegs with the shape of the brush icons in the cleaning head module.

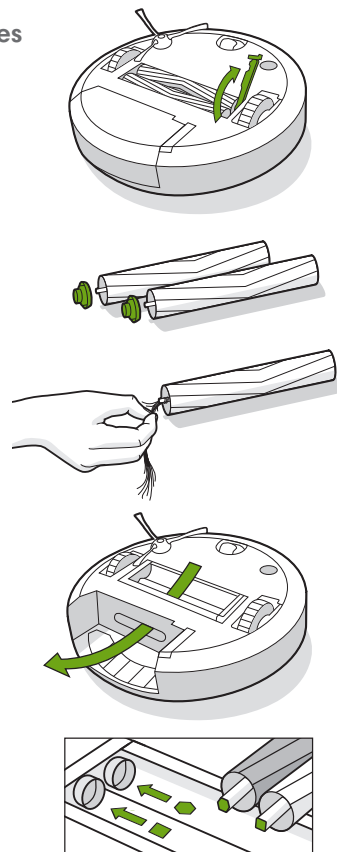

Cleaning the Sensors, Camera Window and Charging Contacts

- 1 Wipe sensors, camera window and charging contacts with a clean, dry cloth.

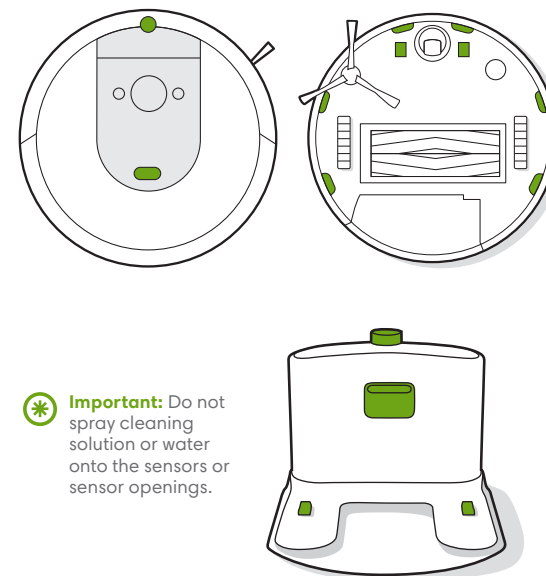

*** Important:** Do not spray cleaning solution or water onto the sensors or sensor openings.

iRobot Customer Care

USA & Canada

If you have questions or comments about your Roomba® robot vacuum, please contact iRobot before contacting a retailer.

You can start by visiting global.irobot.com for support tips, frequently asked questions and information about accessories. This information can also be found in the iRobot HOME App. If you need further assistance, call our Customer Care team at **(877) 855-8593**.

iRobot USA Customer Care Hours

- Monday to Friday, 9AM – 9PM Eastern Time
- Saturday and Sunday 9AM – 6PM Eastern Time

Outside USA & Canada

Visit global.irobot.com to:

- Learn more about iRobot in your country
- Get hints and tips to improve your Roomba® robot vacuum's performance
- Get answers to questions
- Contact your local support center

Regulatory Information

This device complies with part 15 of the FCC Rules and ICES-003. Operation is subject to the following two conditions: (1) This device may not cause harmful interference, and (2) this device must accept any interference received, including interference that may cause undesired operation.

This device complies with Industry Canada license-exempt RSS standard(s). Operation is subject to the following two conditions: 1) This device may not cause interference, and 2) this device must accept any interference, including interference that may cause undesired operation of the device.

- Changes or modifications not expressly approved by iRobot Corporation could void the user's authority to operate the equipment.
- This equipment has been tested and found to comply with the limits for a Class B digital device, pursuant to part 15 of the FCC Rules as well as ICES-003 Rules. These limits are designed to provide reasonable protection against harmful interference in a residential installation. This equipment generates, uses and can radiate radio frequency energy and, if not installed and used in accordance with the instructions, may cause harmful interference to radio communications. However, there is no guarantee that interference to radio communication will not occur in a particular installation. If this equipment does cause harmful interference to radio or television reception, which can be determined by turning the equipment off and on, the user is encouraged to try to correct the interference by one or more of the following measures:

iRobot®

©2018 iRobot Corporation, 8 Crosby Drive, Bedford, MA 01730 USA. All rights reserved.
iRobot, Roomba, iAdapt and Virtual Wall are registered trademarks of iRobot Corporation.
Home Base and Dirt Detect are trademarks of iRobot Corporation. Wi-Fi and the Wi-Fi logo are registered trademarks of Wi-Fi Alliance.

- Reorient or relocate the receiving antenna.
- Increase the separation between the equipment and receiver.
- Connect the equipment into an outlet on a circuit different from that to which the receiver is connected.
- Consult the dealer or an experienced radio/TV technician for help.
- Under Industry Canada regulations, this radio transmitter may only operate using an antenna of a type and maximum (or lesser) gain approved for the transmitter by Industry Canada. To reduce potential radio interference to other users, the antenna type and its gain should be so chosen that the equivalent isotropically radiated power (e.i.r.p.) is not more than the necessary for successful communication.
- FCC Radiation Exposure Statement: This product complies with FCC §2.1093(b) for portable RF exposure limits, set forth for an uncontrolled environment and is safe for the intended operation as described in this manual.
- ISED Radiation Exposure Statement: This product complies with the Canadian Standard RSS-102 for portable RF exposure limits, set forth for an uncontrolled environment and is safe for the intended operation as described in this manual.

For battery recycling go to call2recycle.org;
or call 1-800-822-8837



