

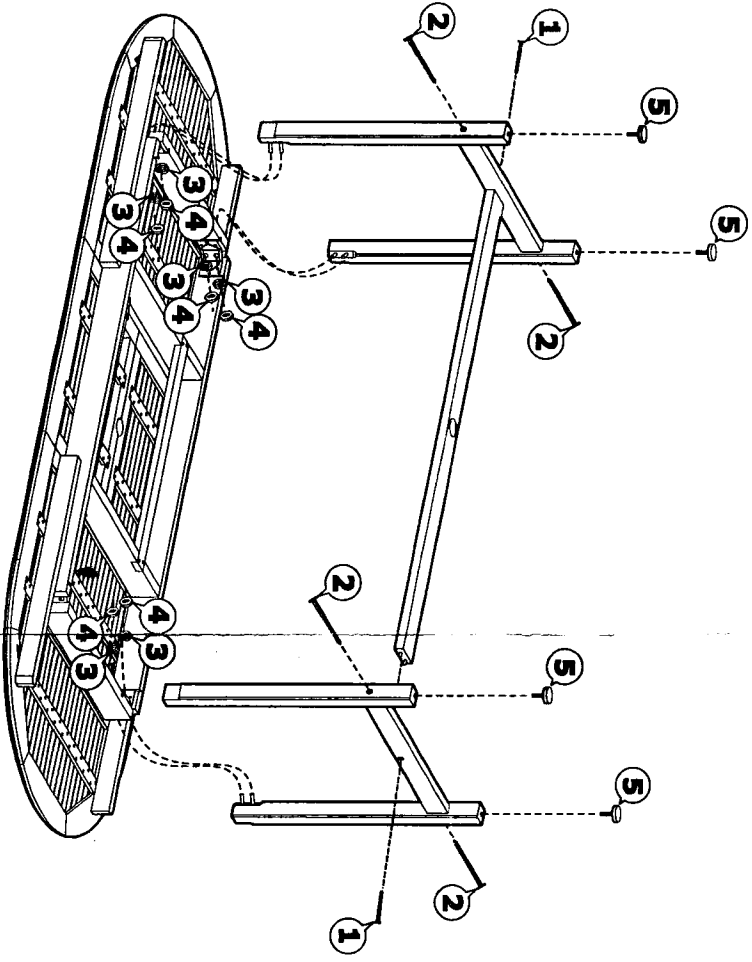









Assembly Instruction

Date : 29 Dec 2010, Revision : 1

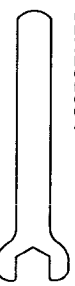

- 1  F-screw 6x70-T30, GS x 2 PCS
SEM201428
- 2  F-screw 6x80-T30, GS x 4 PCS
SEM201429
- 3  Spiral washer 8x13x2, GS x 8 PCS
SEM201346
- 4  Hexagonal nut M8, GS x 8 PCS
SEM201071
- 5  Table foot black, P x 4 PCS
SEM201054
- 6  Hexagonal key M8, GS x 1 PCS
SEM201301
- 7  Torx key T30, GS x 1 PCS
SEM201430
- 8  SC brass center for ph, Ø 50mm, SB x 1 PCS
SEM600001

DIAN EXT. OVAL DINING TABLE 71"-94"X39", 29"H, W/ PH, TEA

SEM102507