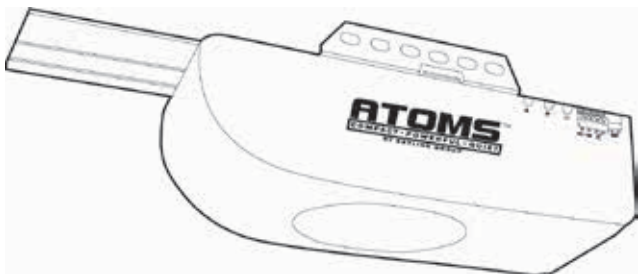

DC Motor Chain Drive

ATOMS™/ATOMS+™ GARAGE DOOR OPENER

IMPORTANT:

- Please read this manual and enclosed safety materials carefully!
- Safety Infrared Sensor **MUST BE INSTALLED** and aligned properly.
- Periodic checks of the opener are required to ensure safe operation.
- Save this manual for future reference.
- This Equipment meets or exceeds all Federal, State and UL325 Safety Requirements.
- For more information, updates and useful links, please visit our website <http://skylinkhome.com>

DO NOT RETURN TO THE STORE
ENGLISH
 P/N: 101Y386-003

TABLE OF CONTENT

INTRODUCTION	3
PRE-INSTALLATION CHECKLIST	4
WHAT IS INCLUDED	5
IMPORTANT INSTRUCTIONS	8
ASSEMBLE THE T-RAIL	9
INSTALL THE HEADER BRACKET	14
HANG THE OPENER	17
INSTALL THE DOOR BRACKET	19
INSTALL THE DOOR ARMS	21
INSTALL THE WALL BUTTON/CONSOLE FOR ATOMS™	23
INSTALL THE LCD WALL CONSOLE FOR ATOMS+™	25
CONNECT THE OPENER TO POWER	26
INSTALL SAFETY BEAM SENSOR	28
PROGRAMMING GUIDE - ATOMS™ & ATOMS+™	33
PROGRAMMING GUIDE - LCD WALL CONSOLE (ATOMS+™ ONLY)	37
SAFETY TEST	41
OPERATIONS - ATOMS™	42
MAINTENANCE	48
BACKUP BATTERY	50
TROUBLE SHOOTING	53
PROGRAMMING TO THE INTERNET HUB	56
ACCESSORIES	58
FCC	59
LIMITED WARRANTY	60
CUSTOMER SERVICE	61

INTRODUCTION

Congratulations on your purchase of Skylink Garage Door Opener, a garage door opener with many innovative features. Features include extremely quiet operation with DC motor; automatic force adjustment so the door can be closed with just the right amount of force, not overpowered; state of the art safety reversal systems that protect your family and property near the door.

Important Safety Information

This documentation provided with your opener has been carefully designed and organized to make the assembly, operation and continued maintenance of your product as easy and safe as possible, provided it is installed, operated, maintained and tested in strict accordance with the instructions and warnings contained in this manual. Read and follow all guidelines and operating instructions before the first use of this product. Store the manual in a safe, easily accessible location.

Safety Symbol Overview

WARNING

- This type of warning symbol is used to indicate possible mechanical hazards that may cause serious injuries or death.

CAUTION

- This type of warning symbol is used to indicate the possibility of damage to the garage door or opener.

PRE-INSTALLATION CHECKLIST



Sectional Door

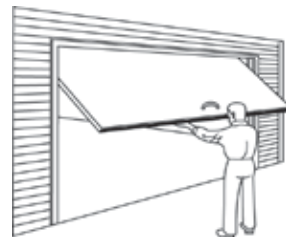

One -Piece Door

Check the following items before assembling the opener:

- Identify the door type: sectional door or one-piece jamb door.
- Ensure your garage door is balanced and is not sticking or binding.
- Here is how to check the door balance:
 - From outside the garage, slowly open the door all the way and close it all the way – DOOR SHOULD NOT BIND OR RUB.
 - Raise the door halfway up – DOOR SHOULD STAY IN PLACE, SUPPORTED ENTIRELY BY ITS SPRING.

IMPORTANT

- IF THE GARAGE DOOR FAILS EITHER OF THESE TESTS, HAVE A QUALIFIED GARAGE DOOR PROFESSIONAL ADJUST OR REPAIR THE DOOR.
- If the garage door is lightweight (made with frame and skin, not solid), it must be braced or reinforced before installing the opener (including the door frame). Check with a qualified service professional for a door reinforcement kit.
- If you do not have an access door in addition to the garage door, you should install an emergency key release kit.
- If your door is more than 7' (2.1 m) high, you will need a rail extension kit (sold separately).
- With the garage door closed, check alignment of door and garage floor. The gap, if any, should be no more than 1/4" (6 mm). If the gap is larger than this, repair floor or door before installing opener.

WHAT IS INCLUDED

The garage door opener and all accessories are packaged in one carton.



Push Button*



Wall Console*



LCD Wall Console*



Keyless Entry*



Safety Beam Unit



Trolley



Keychain Remote*



Pulley Assembly



Door Bracket



Head Bracket



Bell Wire



Sprocket Cover



Emergency Release Rope

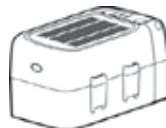

Backup Battery*



Internet Hub*



NOTE

* Note that accessories will depend on the model you purchased. If anything is missing, carefully check the packing material.

WHAT IS INCLUDED



Safety Labels

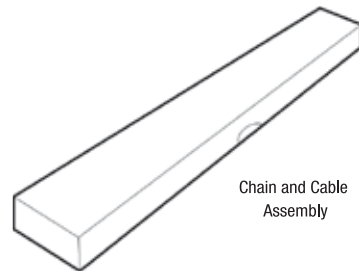

Chain and Cable Assembly

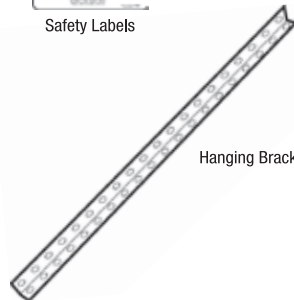

Hanging Bracket

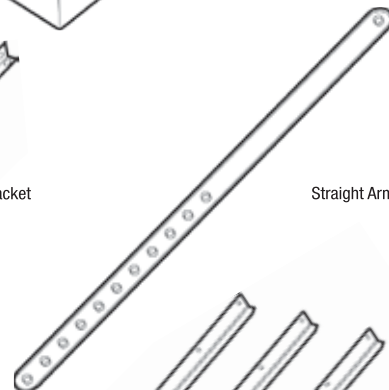

Straight Arm

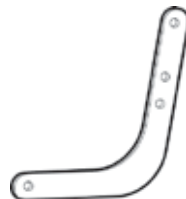

Curved Arm

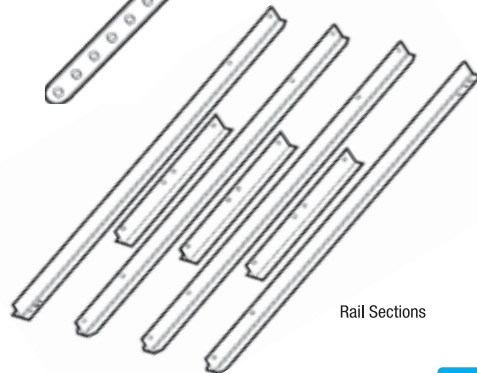

Rail Sections

WHAT IS INCLUDED



A1 x 12
Carriage Bolt

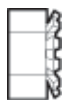

A2 x 12
Locknut

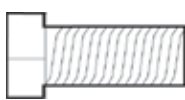

A3 x 2
Bolt



A4 x 3
Locknut

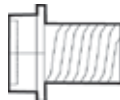

A5 x 3
Flange Bolt



B1 x 4
Lag Screw

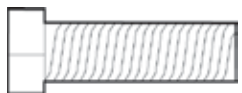

B2 x 4
Bolt

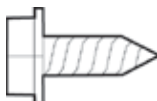

B3 x 2
Self-tapping Screw



B4 x 1
Clevis Pin



B5 x 1
Clevis Pin



B6 x 3
Hitch Pin



B8 x 4
Locknut

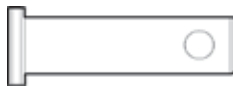

B9 x 1
Clevis Pin



C2 x 4
Wire Clip



C3 x 20
Wire Holder



C5 x 4
Wood Screw

IMPORTANT INSTRUCTIONS

To reduce the risk of severe injury or death:

1. READ AND FOLLOW ALL INSTALLATION INSTRUCTIONS.
2. Check with the door manufacturer to determine if additional reinforcement is required to support the door prior to installation of the garage door opener.
3. Install garage door opener only on a properly balanced garage door. An improperly balanced door could cause serious injury. Have a qualified service professional make repairs to garage door cables, spring assemblies and other hardware before installing the opener.
4. Remove all ropes and disable all locks connected to the garage door before installing opener.
5. Mount the emergency release handle 6' (1.8 m) above floor.
6. Do not connect the opener to source of power until this manual instructs you to do so.
7. Locate the wall console or wall console:
 - A. Within sight of the garage door.
 - B. Out of reach of children at minimum height of 5' (1.5 m).
 - C. Away from all moving parts of the door.
8. Place entrapment warning label on wall next to garage door wall control.
9. Install the Emergency Release Handle on the emergency release rope.
10. Place manual release/safety reverse test label in plain view on inside of garage door.
11. Upon completion of the installation, the door must reverse when it comes in contact with a 1 1/2" (3.8 cm) high object on the floor (or a 2x4 laid flat at the centre of the door) and when the infrared safety beam is blocked.

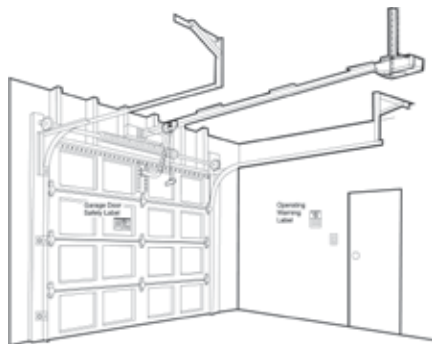

An overall view of a completed garage door opener system installed on a sectional door. The arrangement is similar for a one-piece jamb door (except for differences described later in this manual).

ASSEMBLE THE T-RAIL

1. Connect the T-Rail Sections

Align the 4 T-Rail sections on the floor. Connect these rails together with the rail couplers as shown. All rail pieces must be aligned properly.

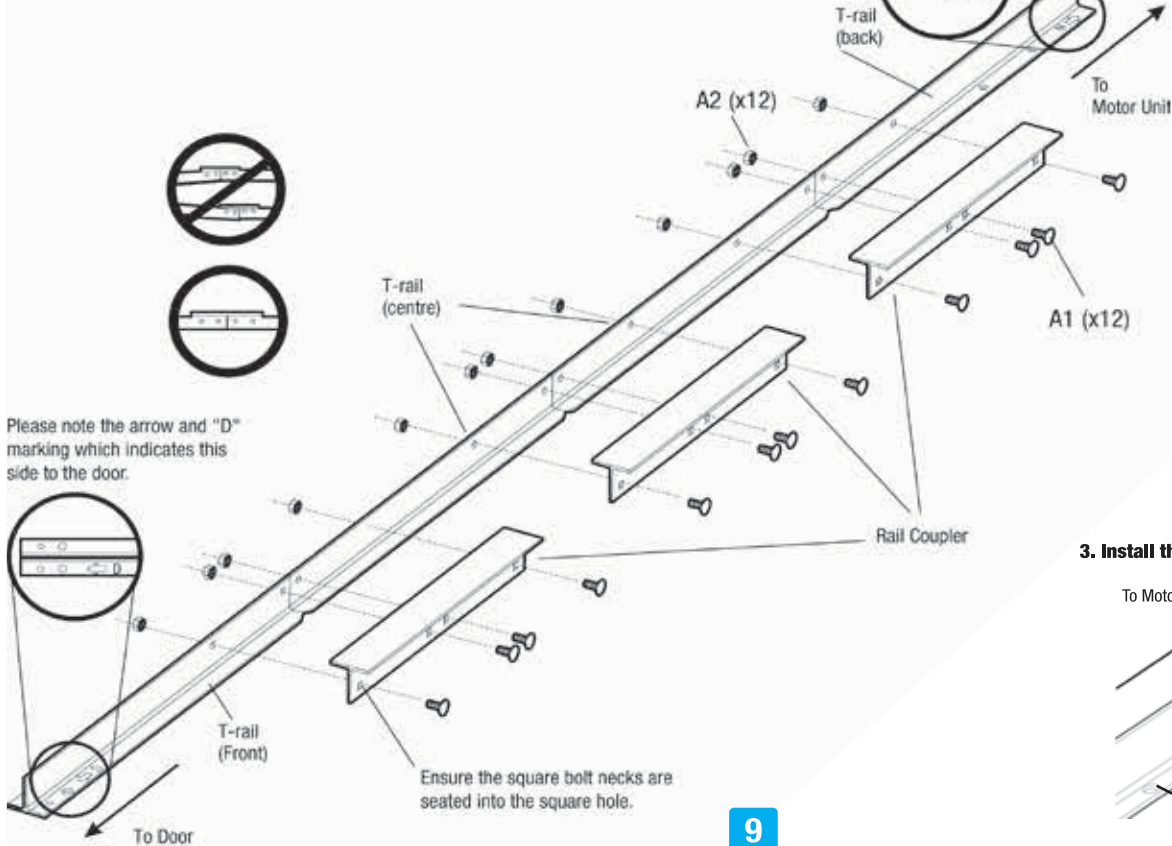

9

ASSEMBLE THE T-RAIL

Please note the arrow and "M" marking which indicates this side to the motor unit.

2. Attach the Pulley Bracket

Attach the pulley bracket assembly to the end of the front rail with 2 nuts and bolts.

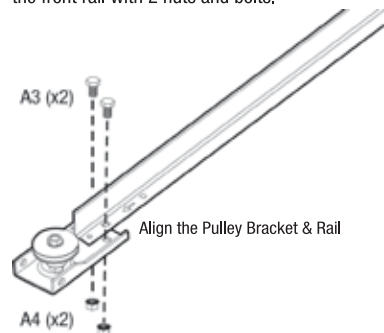

3. Install the Trolley

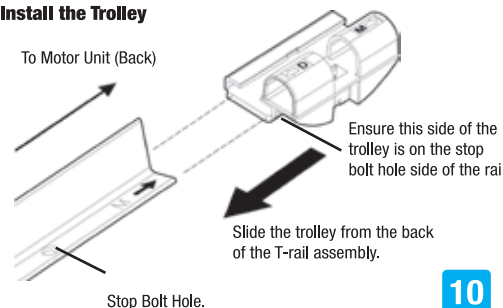

10

ASSEMBLE THE T-RAIL

4. Attach the T-Rail to the Opener

Raise the pulley end of the rail so the rail can sit on the motor unit properly. Attach the rail to the motor unit by tightening 2 screws. Insert a bolt to the stop bolt hole and secure it with nut.

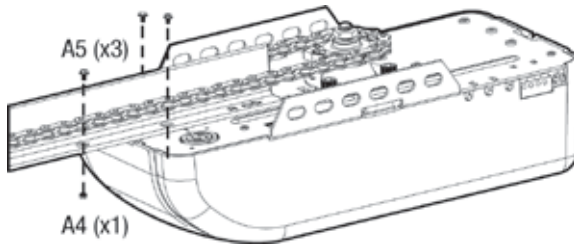

5. Garage Door Safety Label

Affix this label to the inside of your garage door.

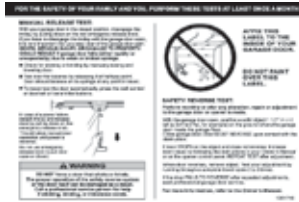

6. Prepare the Chain

Lay down the chain on the floor, as shown. Do not twist the chain or cable.



CAUTION

- Use only the specified bolts to attach the T-rail to the opener. Any other bolts will cause serious damage to the opener.

11

ASSEMBLE THE T-RAIL

7. Align the Chain on the Sprocket

Start aligning the chain by placing the turnbuckle 10" (25 cm) from the sprocket. Wrap the chain around the sprocket. The sprocket teeth must engage the chain as shown.

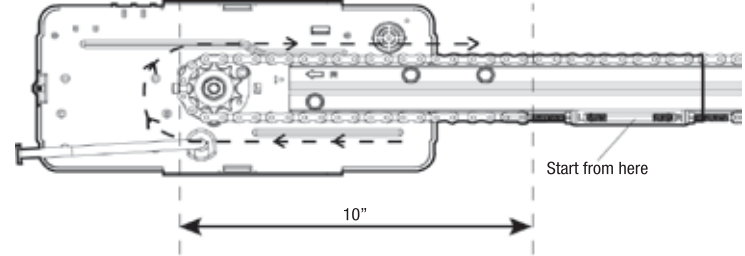

8. Place the Cable on the Pulley

Place the cable around the pulley at the end of the rail.

Ensure chain/cable passes through the trolley guides. Insert the trolley guides into the chain traveller until you hear a click when the chain traveller is completely seated into the trolley.

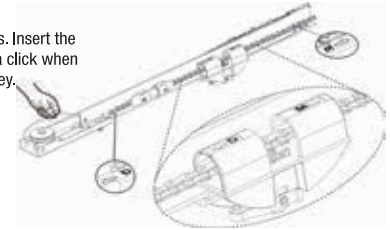

9. Tighten the Chain and Cable

Connect the 2 ends of the chain assembly together at the turnbuckle.

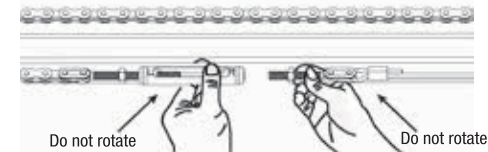

IMPORTANT

- Rotate turnbuckle only while tightening.

12

ASSEMBLE THE T-RAIL

To connect the turnbuckle and threaded shaft, hand tighten the turnbuckle by rotating the turnbuckle only.

Do not rotate the threaded shaft to avoid twisting the cable.

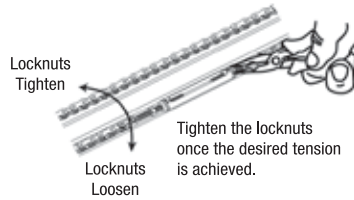

To avoid twisting the cable, use pliers to hold the threaded shaft while tightening the turnbuckle with a flat screwdriver.

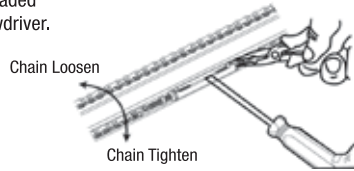

Twist the turnbuckle to tighten the chain tension until the chain is 1/3" (8 mm) above the base of the T-rail.

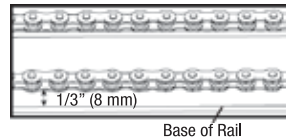

10. Attaching the Sprocket Cover

Squeeze the cover slightly and insert the 2 tabs on the cover in the slots on the motor unit.

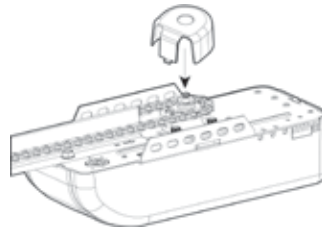

NOTE

- After completing the installation, you may notice some chain drop with the door fully closed. The chain should return to the position as shown when the door is open.
- Too much or too little tension will cause excessive noise.

13

INSTALL THE HEADER BRACKET

1. Mark the Door Centerline

Close the door from inside the garage and mark the vertical centreline of the door on the wall and the top door panel.

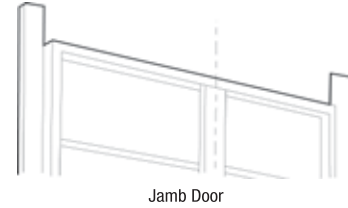
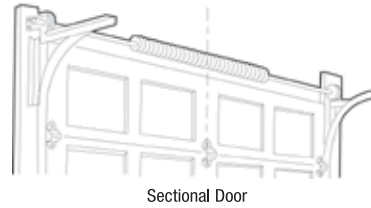

2. Mark Above the Highest Point of Travel

Close the door from inside the garage and mark the vertical centreline of the door on the wall and the top door panel.

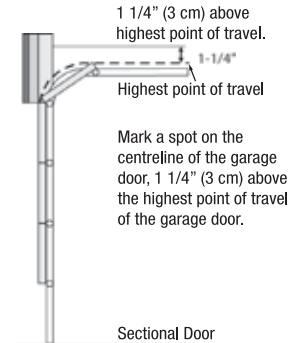
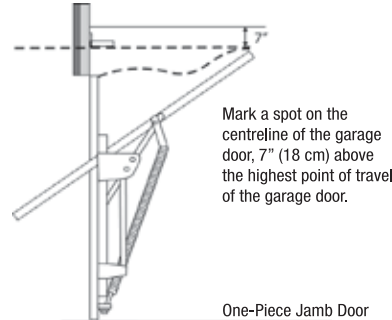

WARNING

- Header bracket must be secured to structural supports. If appropriate support does not exist, install a new support using 2x4 board on drywall or between 2 studs with lag screws (not included). DO NOT install header bracket over drywall.
- Concrete anchors must be used if mounting header bracket or 2x4 into masonry.
- Always call a trained door systems technician if garage door binds, sticks, or is out of balance. An unbalanced garage door might not reverse when required.

14

INSTALL THE HEADER BRACKET

3. Attach a 2x4 (if necessary)

If the calculated header bracket is above the door header, attach a 2x4 between two studs to install the header bracket.

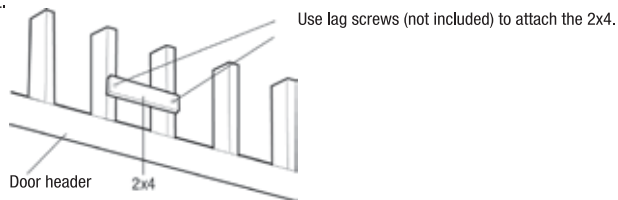

4. Attach the Header Bracket

Place the bottom edge of the bracket on the line marked above the highest point of travel.

1 1/4" (3 cm) Above
Sectional Door or

7" (18 cm) Above
One-piece Jamb Door

Mark the 2 holes
with a pencil.

Drill two 3/16" (5 mm)
pilot holes.

Attach the header bracket with
2 lag screws provided.

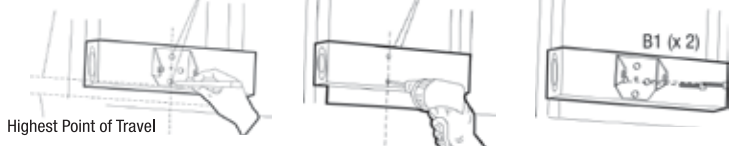

Note the orientation of the header bracket. Do not mount it upside down.

Ceiling Installation

The header bracket may be mounted to the ceiling if there is minimal clearance above the door. If so, extend the centreline to the ceiling. The back edge of the bracket must not be further than 5" (12.7 cm) from the header wall.

5" (12.7 cm)

INSTALL THE HEADER BRACKET

5. Position The Opener

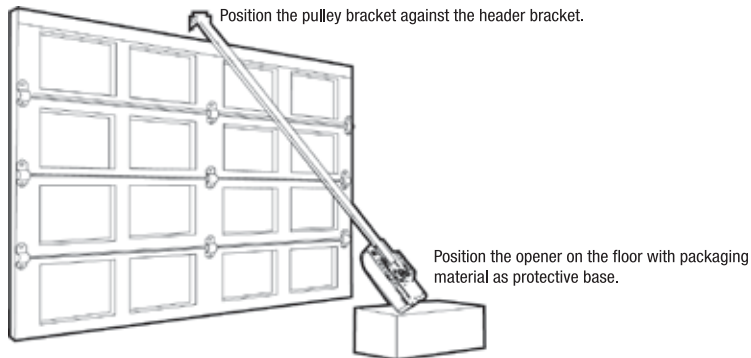

6. Connect the T-Rail to the Header Bracket

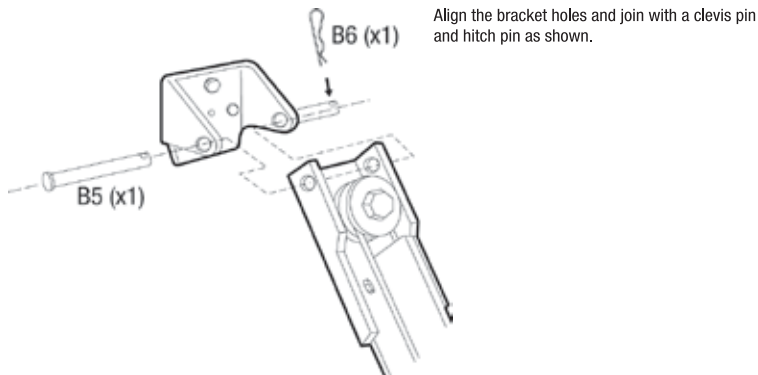

1. Raise the Opener

Raise the opener onto a stepladder. Use extra spacers on top of the ladder if the ladder is not tall enough.

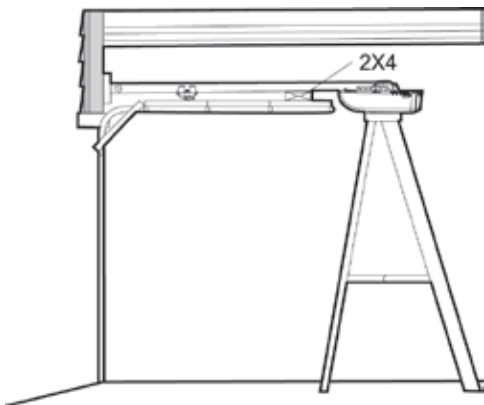

Sectional Door

Carefully raise the door to the fully open position. Be sure the door is clear from the rail or any other part of the opener.

Place a 2x4 laid flat on the top section beneath the T-rail.

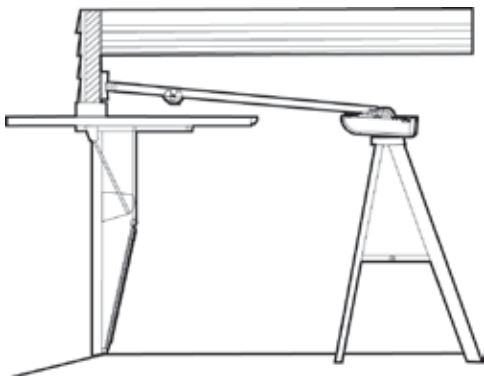

One-piece Jamb Door

Carefully raise the door to the fully open position so that it is parallel to the floor.

Position the opener so that top of the opener head is level with the top of the opened door.

2. Attach the Hanging Brackets

Hanging brackets should be angled to provide rigid support. Measure the distance from the motor unit to the structural support. Cut and bend the hanging brackets as required.

For an "open-seam" garage, attach the hanging brackets directly to the joists with 2 lag screws.

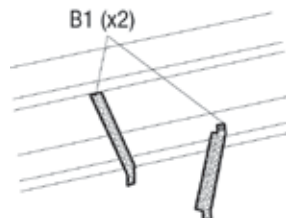

On a finished ceiling, attach a sturdy metal bracket (not included) to structural supports before installing

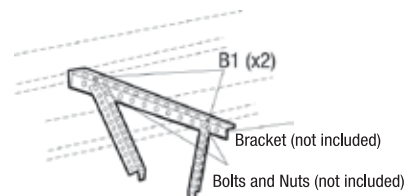

3. Attach the Opener to the Hanging Brackets

Attach the opener to the hanging brackets with two bolts and nuts.

Ensure the T-rail is centred over the door. Remove the 2x4.

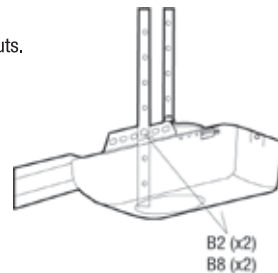

! WARNING

- To avoid possible serious injury from a falling garage door opener, fasten it securely to structural supports of the garage. Concrete anchors must be used if installing any brackets into masonry.

INSTALL THE DOOR BRACKET

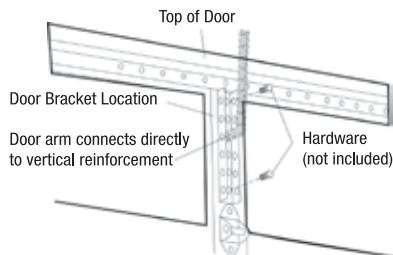

Sectional Wood Doors

For wood doors, drill 5/16" (8 mm) holes through the door and secure bracket with 5/16 x 2" (8 x 50 mm) carriage bolts, lock washers and nuts (not included).

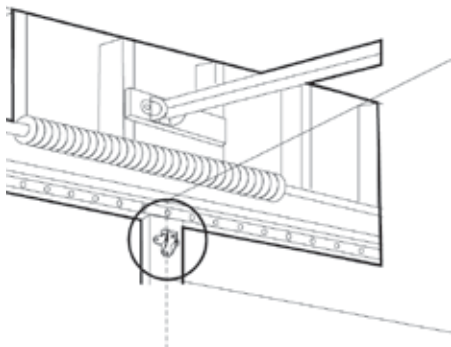

Sectional Metal Doors

Align the door bracket on the centreline 2" to 4" (5 to 10 cm) below the top edge of the door, or directly below any door structural support.

Drill two 3/16" (5 mm) pilot holes. Use 2 self-threading screws to secure the door bracket.

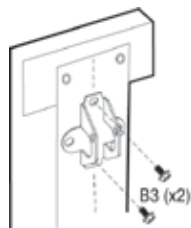
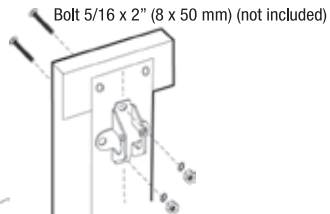

INSTALL THE DOOR BRACKET

One-Piece Wood Doors

For wood doors, drill 5/16" (8 mm) holes through the door and secure bracket with 5/16 x 2" (8 x 50 mm) carriage bolts, lock washers and nuts (not included).

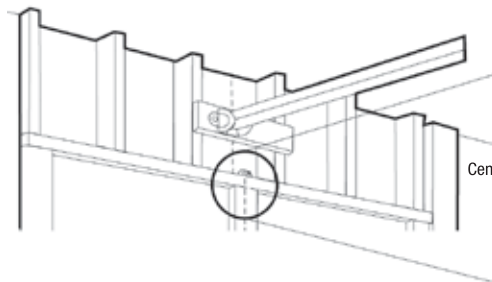

Bolt 5/16 x 2" (8 x 50 mm) (not included)



Centre the door bracket on the top of the door.

One-Piece Metal Doors

Drill two 3/16" (5 mm) pilot holes. Use 2 self-threading screws to secure the door bracket.

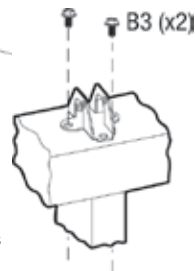

CAUTION

Lightweight garage doors are not designed for use with garage door opener must be equipped with a door reinforcement kit. Check with the garage door manufacturer for more information. Many door reinforcement kits provide for direct attachment of the clevis pin and door arm. In this case, you will not need the door bracket, proceed to "Install the Door Arms" section.

INSTALL THE DOOR ARMS

1. Attach Emergency Release Rope

Thread the red rope through the hole in the trolley release handle and tie an over-hand knot. Leave the trolley release lever in the released position until further testing is completed.

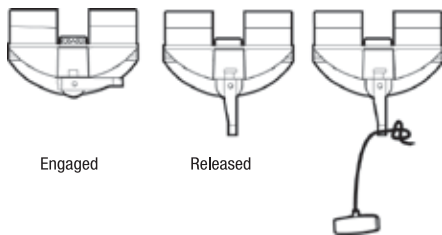

2. Connect the Door Arm to Door Bracket

Sectional Door

Connect the curved door arm to the door bracket with clevis pin and hitch pin.

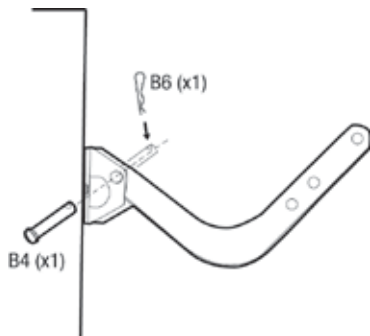

One-piece Jamb Door

Connect the straight arm to the door bracket with clevis pin and hitch pin.

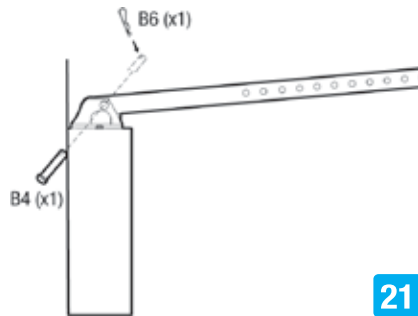

INSTALL THE DOOR ARMS

3. Connect the Door Arm to the Trolley

Sectional Door

Connect the straight door arm to the trolley with clevis pin and hitch pin.

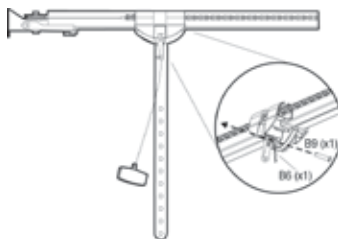

One-piece Jamb Door

Connect the curved door arm to the trolley with clevis pin and hitch pin.

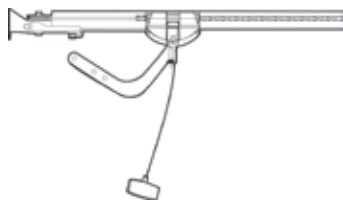

4. Connect the Door Arms Together

Bring two arms together. Find two pairs of holes that line up and join 2 arms with bolts and nuts. Select holes as far apart as possible to increase door arm rigidity.

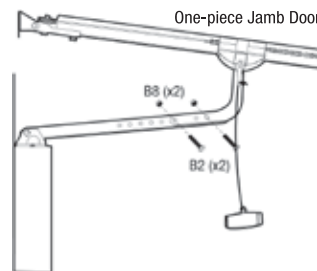
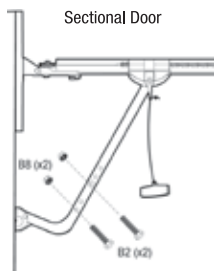

NOTE:

- Emergency release handle should hang 6' (1.8 m) above floor. Adjust rope length if it is necessary.

WARNING

- Use extreme care when pulling release handle, DO NOT use handle to pull door open or closed.
- Never use emergency release handle unless garage doorway is clear of persons and obstructions.

INSTALL THE WALL BUTTON/CONSOLE FOR ATOMSTM™

1. Location

Place the wall button or wall console at least 5' (1.5 m) above the finished floor or the topmost step.

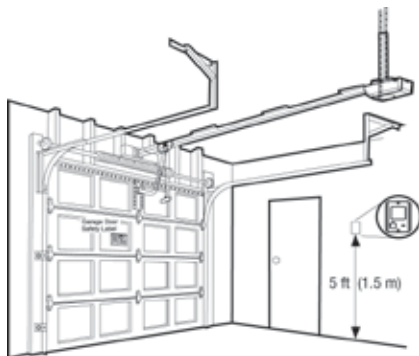

2. Connect the bell wires to the 2 terminal screws

Wires are not polarity sensitivity.

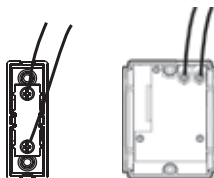

3. Install the Wall Button/Console

Secure the wall console with two screws.

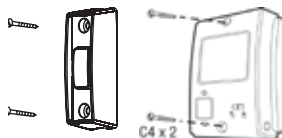

WARNING

- Wall console must be installed within sight of the garage door, out of reach to children at a minimum height of 5' (1.5 m) and away from all moving parts of door.
- Be sure power is not connected before installing the wall console.
- Wall console should only be activated when door can be seen clearly, is properly adjusted and there are no obstructions to door travel.
- Always keep garage door in sight until completely closed. Never permit anyone to cross path of closing garage door.

23

INSTALL THE WALL BUTTON/CONSOLE FOR ATOMSTM™

4. Operator Warning Label

Mount the user safety instruction label next to the wall console.



5. Route and Secure the wires

Route the wire up the wall and across the ceiling to the opener with wire holders.

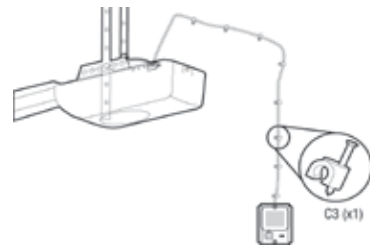

6. Connect the Wires to the Opener

Connect the wires to the  terminals. Wires are not polarity sensitivity (either wire to either terminals).

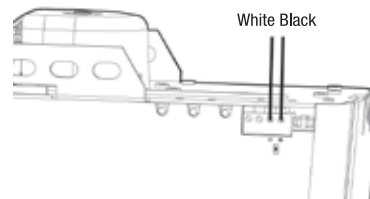

24

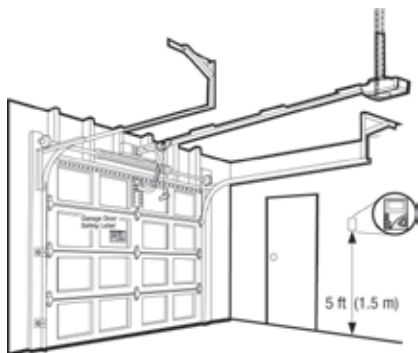

1. Install the LCD Wall Console

Locate the wall console at least 5' (1.5 m) above the finished floor or the topmost step.

2. Secure the mounting bracket with two screws

3. Slide the wall console onto the mounting bracket until you hear a click.

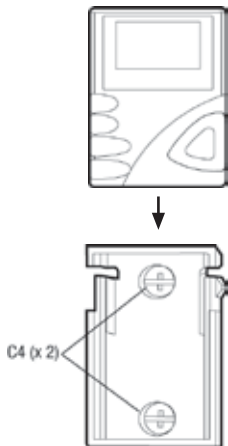

WARNING

- Wall console must be installed within sight of the garage door, out of reach to children at a minimum height of 5' (1.5 m) and away from all moving parts of door.
- Be sure power is not connected before installing the wall console.
- Wall console should only be activated when door can be seen clearly, is properly adjusted and there are no obstructions to door travel.
- Always keep garage door in sight until completely closed. Never permit anyone to cross path of closing garage door.

1. Connect AC Power

Plug motor unit into grounded outlet. If a grounded outlet is not available, contact a qualified electrician to install a proper outlet. DO NOT ACTIVATE THE OPENER UNTIL INSTRUCTED.

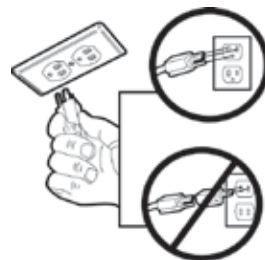

2. Permanent Wiring/Remove Cover

Be sure the power cord is unplugged. Remove the screws from the cover of the opener.

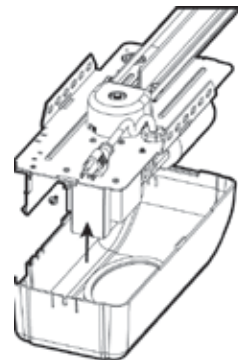

WARNING

- If permanent wiring is required by your local code, have a licensed electrical contractor follow the procedures outlined in this manual. Disconnect power to the circuit before removing cover.
- Be sure power is not connected to the opener and disconnect power to circuit before removing cover to establish permanent wiring connection.
- Garage door installation and wiring must be in compliance with all local electrical and building codes.
- Never use an extension cord, 2-wire adaptor, or change plug in any way to make it fit outlet. Be sure the opener is grounded.
- The opener has a grounded type plug for your protection and only fit into a grounding type outlet. Do not change the plug in any way.

CONNECT THE OPENER TO POWER

3. Permanent Wiring/Remove the Power Cord

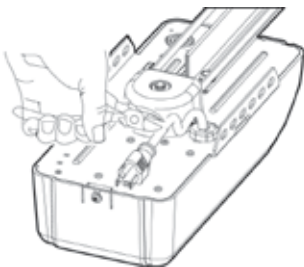

4. Permanent Wiring/Remove the Bushing

Be sure the power cord is unplugged. Cut the cord about 6" (15 cm) above the bushing.

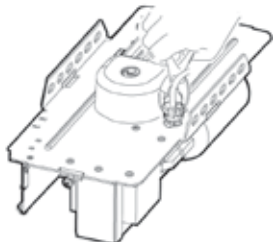

Remove the bushing with pliers.

5. Permanent Wiring/Hardwire the Opener

Connect the conduit to the opener with the proper termination. Connect conduit wiring to opener wiring with wire nuts (not included). Install the bottom cover and screws.

Green – Ground
White – Neutral
Black – Hot

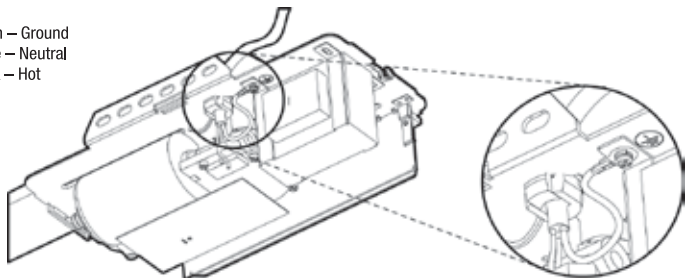

27

INSTALL SAFETY BEAM SENSOR

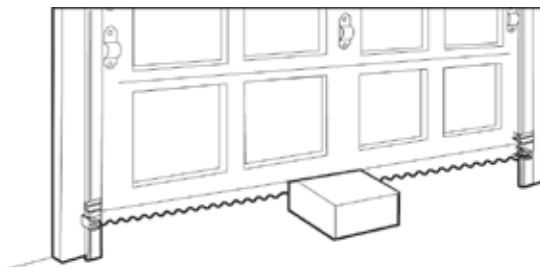

Important Information: The safety beam sensor can detect obstacles in the path of its invisible beam. When the beam is obstructed while the door is closing, the door will stop immediately, reverse to the fully open position and the opener lights will flash. It is important to ensure the invisible infrared is unobstructed by any part of the garage door, tracks, other hardware or objects near the garage door.

1. Identify the Transmitter and the Receiver

The unit with the red LED is the transmitting sensor. The unit with the blue LED is the receiving sensor. Avoid sunlight shining directly into the receiving sensor.

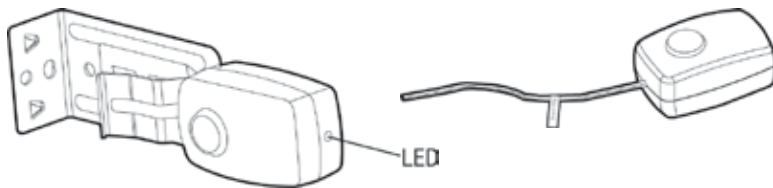

NOTE

- Receiving sensor is labelled "Receive" on the wire.

WARNING

- Be sure power is not connected to the garage door opener while installing the safety beam sensor.
- The safety beam sensor must be installed and aligned properly.
- This safety device must not be disabled.
- The safety infrared sensor must not be installed higher than 6" (15 cm) above the garage floor.

28

INSTALL SAFETY BEAM SENSOR

2. Mounting the Sensor on the Door Track

Clip the mounting bracket onto the garage door track. Ensure the sensor is mounted between 4" (10 cm) and 6" (15 cm) above the ground. Follow the same procedure to install the sensor on the other track ensuring the sensors are facing each other.

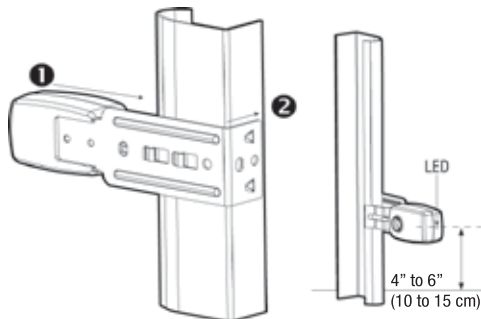

3. Mounting the Sensor on the Wall (Optional)

For wall mounting, use a wooden block to increase depth providing enough clearance for the sensor beam to be unobstructed.

4. Mounting the Sensor on the Floor (Optional)

For floor mounting, use a wooden block to elevate the sensor brackets, if necessary. Ensure the sensor is no higher than 6" (15 cm) above floor. Fasten the screws to the floor with concrete anchors (not included).

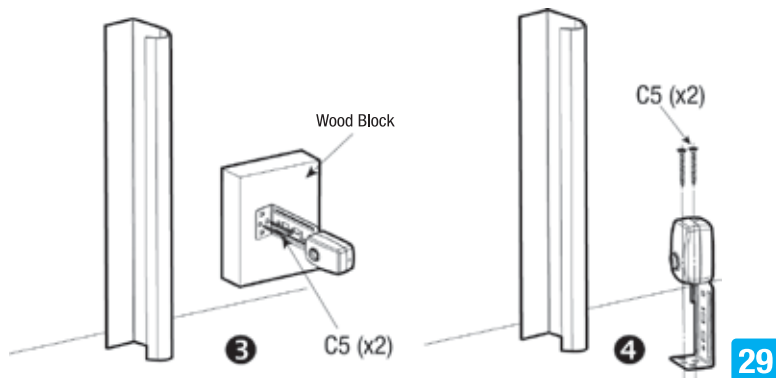

29

INSTALL SAFETY BEAM SENSOR

NOTE

Remove the spring bracket from the mounting bracket if installing to the wall or floor.

1. Slide the sensor from the mounting bracket.
2. Slide the spring bracket from the mounting bracket.
3. Re-install and secure the sensor to the mounting bracket.

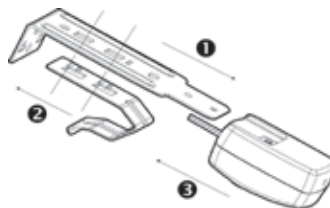

5. Route and Secure the Sensor Wires

Run the wires up the wall, then over to the centre of the door. Secure the wires to the wall with wire holders. Run the wires along the top of the T-rail and secure them with 4 wire clips provided.

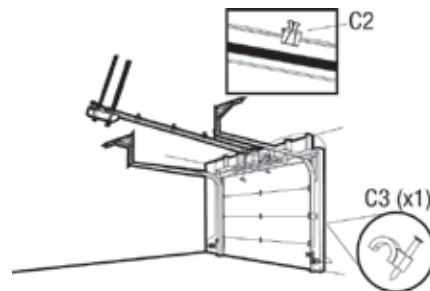

6. Connect the Wires to the Opener

Twist like-coloured wires together. Connect the wires to the (■) (■) terminals. Wires are not polarity sensitivity (either wire to either terminal).

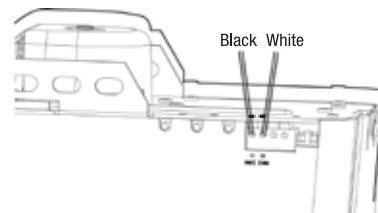

30

INSTALL SAFETY BEAM SENSOR

7. Check the Safety Beam Sensor LED

Plug in the opener. The receiving sensor indicator's blue LED should glow steadily if the wiring and alignment are correct. The transmitting sensor indicator's red LED will glow steadily regardless of alignment or obstruction.

Align the sensors

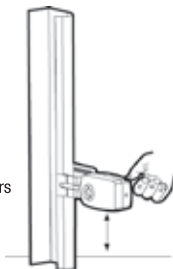

8. Align the Safety Beam Sensor

If the receiver LED is off, dim, or flickering (while the invisible light beam path is not obstructed), alignment is required.

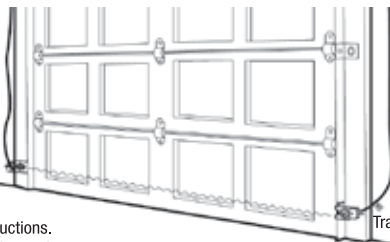

Receiving Sensor (Blue LED)

Blue Light:

On – Beam Aligned. No Obstructions.

Off – Beam Not Aligned Or Obstruction

– Sensors Need Alignment.

Dim/Flickering – Sensors Need Alignment.

Transmitting Sensor (Red LED)

Red Light:

On – Power On.

Off – Power Off.

If the blue LED is flashing or off, slide the mounting bracket up or down on the track until the blue LED is steadily on. The tab for the sensor can also be adjusted by a slight bend if needed for alignment. When properly adjusted both the red and blue LED will be steadily on.



NOTE

- Be sure to stay out of the beam's path while aligning.
- After two minutes the sensors will go into sleep mode and the red and blue LED will flash every 10 seconds. When the door is closing, the sensors will return to normal operation with red and blue LED steadily on.

31

INSTALL SAFETY BEAM SENSOR

9 Testing with Obstruction

With the sensors properly aligned, place an obstacle in the path of the beam. The transmitting sensor's red LED should be on, the receiving sensor's blue LED should be off. Remove the obstacle, both LEDs should be on steadily.

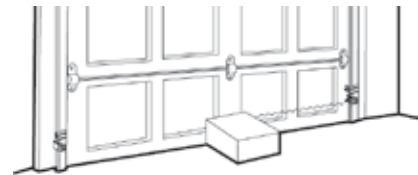

NOTE

If the transmitting sensor LED does not glow steadily, check the following:

- I. Power to the opener is connected.
- II. A short in the white or white/red wires (from wire holders or at the openers terminals).
- III. Incorrect wiring between sensors and opener.
- IV. A broken wire.

If the transmitting sensor LED glows steadily but the receiving sensor LED doesn't glow:

- I. Check alignment.
- II. Check for an open wire to the receiving sensor.
- III. Check for dirt on lens, or sun shining into lens.

32

While programming, the ▲ and ▼ buttons can be used to move the door as needed.

A. Set Up Travel Limit and Open/Close Force

1. Connect the opener to an approved power source. The dot in the LED display stays on.

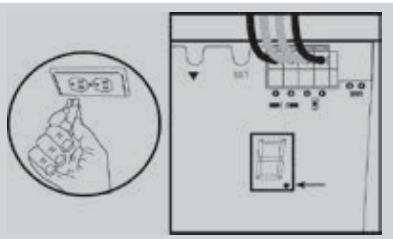

2. Press and hold [Set] button for 5 seconds until the LED display shows the number “1”. Release the [Set] button.
3. Press the [▲] button until the door is in fully open position.
4. Press the [Set] button to confirm the door position.

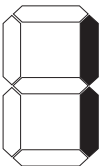

SET DOOR TRAVEL LIMIT (OPEN/CLOSE)

5. The LED display will show the number “2”.
6. Press the [▼] button until the door is in fully closed position.
7. Press the [Set] button again to confirm.
8. The LED light will flash 3 times when the travel limit settings are completed.



SET DOOR TRAVEL LIMIT (CLOSE/OPEN)

9. The LED display will show the number “3”.
10. Press the wall button to open the garage door to its fully open position.
11. The LED light will flash 3 times.



LEARN DOOR FORCE (OPEN/CLOSE)

12. The LED display will show the number “4”.
13. Press the wall button again to close the garage door to its fully closed position.
14. The LED display will turn off.
15. Press the [SET] button to confirm.



LEARN DOOR FORCE (CLOSE/OPEN)

B. Programming Remote Controls

1. Press the [Set] button for one second. The LED display will show the letter “P”.



LEARN WIRELESS CONTROL

2. Program a Remote:
Within 2 minutes, press any button on the remote that you would like to program to the opener.



3. Once the button on the remote is programmed, the LED display will turn off and emit one beep indicating the programming has been successful.

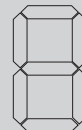

LEARN WIRELESS CONTROL



- During the Force Adjustment, do not obstruct the door’s travel or the safety safety beam sensor.

C. Keypad Initial Setup

The factory default PIN is 0 0 0 0. It will be used during the keypad initial setup. After you set your own PIN, you will need to use your current PIN instead of 0 0 0 0 in below steps.

1. FOR SINGLE DOOR:

- A. Enter 0 0 0 0 and *.
- B. Enter the new PIN (2 to 8 digit password) and *.
- C. Enter your PIN again and *.

If the new PIN codes are the same, the keypad will beep 3 times.

If not, it will emit a long beep.

- D. Press the [SET] Button on the opener.
- E. Within 2 minutes, enter your PIN on the keypad and press #.
- F. Now enter your PIN and # to open/close the garage door.



2. FOR MULTIPLE DOORS:

- A. Enter 0 0 0 0 and * 9 # to enable multiple door mode.
(0 0 0 0 # 0 # to disable and back to single door).
Will beep 2 times to confirm the multiple-door operating mode is enabled.
- B. Enter 0 0 0 0 and *.
- C. Enter the new PIN and press*.
- D. Enter your PIN again and press*.
- E. Press the [SET] Button on the opener.
- F. Within 2 minutes, enter your PIN on the keypad and press #1.
- G. Now enter your PIN and # 1 to open/close the garage door.
- H. Repeat steps E to G to program additional doors:
2nd door: PIN #2, ex. 1 2 3 4 #2
3rd door: PIN #3, ex. 1 2 3 4 #3

D. Erasing all the Remote Controls from Opener

Note: To erase any unwanted remote controls, first erase all remotes.

1. Press the [Set] button for 15 seconds. When the LED display flashes “E”, release the [Set] button.
2. Press the [Set] button again to confirm all the programmed remotes have been erased.
3. The dot in the LED display stays on indicating that erasing the programmed remotes has been successful.







Program your garage door opener with following Option 1 or Option 2.

Option 1: from the Wall Console

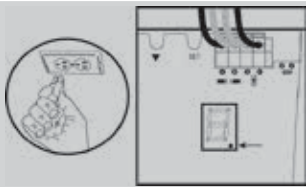

While programming, the  and  buttons can be used to move the door as needed.

1. Connect the opener to an approved power source. The dot in the LED display stays on.



2. Press and hold  button on the wall console for 5 seconds until the LCD display shows the number “1” and up and down arrows are flashing.
3. Press the [] button until the door is in fully open position.
4. Press the [] button to confirm the door position.



5. The LCD display will show the number “2”.
6. Press the [] button until the door is in fully closed position.
7. Press the [] button again to confirm.
8. The LED light will flash 3 times when the travel limit settings are completed.



9. The LCD display will flash the number “3”.
10. Press the [] button to open the garage door. The flashing “3” will change to solid.
11. The LED light will flash 3 times again when the door is fully opened.



12. The LCD display will flash the number “4”.
13. Press the [] button again to close the garage door. The flashing “4” will change to solid.

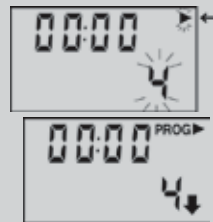

14. The garage door opener will beep once when door is fully closed and the display will show “F”.
15. Press [] to confirm.



16. The LCD display will flash the remote icon.



17. Program a Remote:
Within 30 seconds, press any button on the remote that you would like to program to the opener.
- Program a Wireless Keypad:
Please refer to page 35, part “D. Keypad Initial Setup”.



18. The garage door opener will beep if remote is successfully programmed and the flashing remote icon will change to solid.

19. If you want to erase all the remotes, press and hold the [↓] button for 5 secs until you see “E.”

20. If you need to program additional remote, press [↑] button, then refer to step 18. After you’ve programmed all remotes, press [←] button.

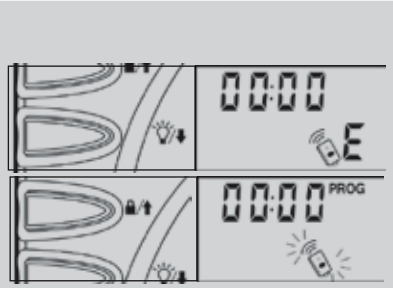

21. The LCD display will show the time setting.

22. Press the [↑]/[+] buttons to set the hour to the current time; then, press [←] to confirm.

23. Press the [↑]/[+] buttons to set the minute to the current time; then, press [←] to confirm.



24. The LCD display will show the remote lock time setting.

25. Press the [↑]/[+] buttons to set hour; then, press [SET] to confirm.

26. Press the [↑]/[+] buttons to set minute; then, press [←] to confirm.



27. The LCD display will show the remote unlock time setting.

28. Press the [↑]/[+] buttons to set the hour; then, press [←] to confirm.

29. Press the [↑]/[+] buttons to set the minute; then, press [←] to confirm.



30. On-ground programming is complete.

Option 2: from the Garage Door Opener

While programming, the ▲ and ▼ buttons can be used to move the door as needed.

Please refer to page 33 - 34, programming the Opener

Test Safety Reversal System

With the door fully open, place a 1 1/2" (3.8 cm) board (or 2x4 laid flat) on the floor, centred under the garage door. Close the door by pressing the button on the wall console. After making contact with the board, the door should stop then reverse to a fully open position.

If the door fails to reverse:

- If the door stops on the obstruction, re-adjust the down travel limit as it is not travelling far enough in the down direction.
- Repeat the test until the door reverses upon striking the obstruction.

Test Safety Beam Sensor System

To test the safety beam sensor system, open the door to the fully open position.

1. Place an obstacle (such as the opener carton) to break the safety infrared beam.
2. Press the push button to close the door.
3. The door should not move more than 1" (2.5 cm), and the opener light will flash. If this does not happen:
 - Ensure the safety beam sensors are aligned properly (refer to "Install Safety Beam Sensor System").
 - Ensure the obstacle is breaking the beam by checking the receiving sensor's blue LED is off.
 - If everything fails, call for a trained door systems technician.

 **WARNING**

- Without a properly installed safety reversing sensor, persons (particularly small children) could be seriously injured or killed by a closing garage door.

Important Safety Instructions **WARNING****To reduce the risk of severe injury or death:**

1. READ AND FOLLOW ALL INSTRUCTIONS CAREFULLY.
2. NEVER let children operate or play with any garage door controls or remote controls. Always keep these controls away from children.
3. Always keep moving door in sight and away from people and objects until it is completely closed. NO ONE SHOULD CROSS THE PATH OF THE MOVING DOOR.
4. Only activate garage door when it can be seen clearly, is properly adjusted and there are no obstructions to door travel.
5. NEVER GO UNDER A STOPPED, PARTIALLY OPEN DOOR.
6. Test the door opener monthly. The garage door MUST reverse on contact with a 1/2" (4 cm) high object (2x4 laid flat) on the floor. Retest the door opener after adjusting the travel limits. Failure to adjust the opener properly may cause severe injury or death.
7. If possible, use the red emergency release only when the door is closed. Use caution when using this release with the door open. Weak or broken springs may allow the door to fall rapidly, causing severe injury or death.
8. Never use the emergency release rope to pull garage door open or closed. If the rope knot becomes untied, you could fall.
9. KEEP GARAGE DOORS PROPERLY BALANCED. (See 'Garage Door Opener Maintenance') An improperly balanced door could cause severe injury or death. Have a qualified service professional make repairs to cables, spring assembly and other hardware.
10. Disconnect the electrical power to the garage door opener before making any repairs or removing the housing cover.
11. This operator system is equipped with an unattended operation feature. The door could move unexpectedly. NO ONE SHOULD CROSS THE PATH OF THE MOVING DOOR.

SAVE THESE INSTRUCTIONS.

Operating the Door

Activate your opener with any of the following:

- Press the wall console
- Press the assigned button on the remote control

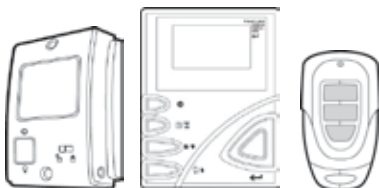

Depends on the status of the garage door opener and the position of the garage door, the garage door opener behaves differently:

- If the door is closed, activating it will open the door.
- If the door is open, activating it will close the door.
- If the door is closing, activating it will stop the door.
- If the door is opening, activating it will stop the door.

If the door is obstructed during operation, the garage door opener will:

- If obstructed while opening, the door will stop.
- If obstructed while closing, the door will reverse.
- The opener light will flash if the opener is obstructed during operation.

Opener Light

The opener light will turn on:

- When the opener is plugged in (light will be off automatically after 3 minutes)
- When the opener is activated (light will be off automatically after 3 minutes)
- The light button is pressed on the wall console

You can manually turn on the light with the Wall Console. Wall Button section of the instructions.

Remote Control

To activate the opener with the remote control, hold down the button until the door begins to move. When the button is pressed, the light indicator on the remote will flash. For remotes with multiple buttons, press the button programmed to the desired operation.



Keypad Operation

Single Door Operation:

Enter the PIN and [#].

For example: 1 2 3 4 #.

Multiple Doors Operation:

Enter the PIN and [#] and [door number].

For example:

Door 1: 1 2 3 4 # 1

Door 2: 1 2 3 4 # 2

Door 3: 1 2 3 4 # 3

Door 4: 1 2 3 4 # 4



SET-UP Auto closer on ATOMS™ (Deluxe Wall Console)

Press the large button on the wall console to activate the garage door opener.



On the wall console there are 3 additional features:

1. Light feature.
2. Lock feature.
3. Door closer timer.

Light Feature:

The light button can be used to turn the opener light on or off. The automatic timer is ignored—the light will remain on until the button is pressed again.

Lock Feature:

The lock button (also known as vacation button) can be used to lock out all remote control transmitters. The door can still be activated by the wall console. Simply slide the switch to the locked position  and the opener will ignore all the radio signals. To unlock, slide the switch to the unlocked position .

Door Closer Timer:

The opener has the option to program how long until the door closes automatically after it has been opened. To change the setting of this timer, there is a slide switch on the side of the wall console.

SLIDE SWITCH POSITION	FUNCTION	RESULT
0	Door Closer Timer Disabled.	The wall console is in lock mode.
3	The door will close automatically after 3 minutes.	<ul style="list-style-type: none"> ● Once the door is opened, the wall console will beep.
10	The door will close automatically after 10 minutes.	<ul style="list-style-type: none"> ● The beeping rate will increase as the timer is running out, indicating the door is about to close.
30	The door will close automatically after 30 minutes.	

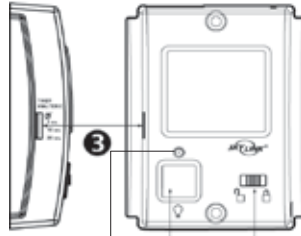

Auto Closer Feature:
LED light stays on - Disable
LED light flash - Enable

SET-UP Auto closer on ATOMS+™ (LCD Wall Console)

The opener has the option to program how long the door should be closed after it has been opened.

1. Press and hold  button for 5 seconds.



2. Press [/+] button to set the auto close time.



3. Select "OFF" = Disable
"03" = 3 mins
"10" = 10 mins
"30" = 30 mins
and press [] to confirm.

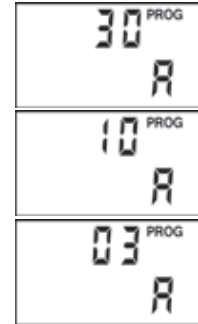

4. The Wall Console will return to Standby Mode, display the current time.



To Open the Door Manually

In case of a power failure or if the door becomes obstructed, pull the red trolley release handle to disengage the opener from the door.

Flip the trolley release level up and raise or lower the door to re-engage the opener.

Use caution if the door is open while disengaging, the door may drop.

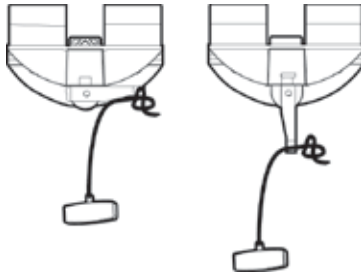
**WARNING**

To prevent possible serious injury or death from a falling garage door:

- If possible, use emergency release handle to disengage trolley only when garage door is closed. Weak or broken springs or unbalanced door could result in an open door failing rapidly and / or unexpectedly.
- Never use emergency release handle unless garage doorway is clear of persons and obstructions.
- Never use handle to pull door open or closed. If rope knot becomes untie, you could fall.

Once a Month

Test the door balance. Manually operate door. If it is unbalanced or binding, call a trained door systems technician.

Check to be sure door opens and closes fully. Adjust limits and / or force if necessary.

Test the Safety Beam Sensor System and Safety Reversal Test.

Once Every Six Months

Check the Chain Tension. Turnbuckle should be slightly above the rail. Refers to page 12 to adjust the chain tension.

Once a Year

Oil the door rollers, bearings and hinges.

Battery Replacement

All remotes come with battery installed. To replace the battery, follow the instructions below.

It is time to change the battery when the red LED on the remote does not turn on when either button is pressed.

To replace the battery:

Undo the two screws on the back of the remote. The bottom case will then come off.

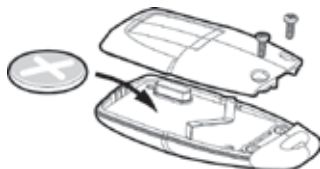

Lithium battery CR-2032 included.
(Positive side up)

Take out the old battery.

1. Place the new battery in position.
2. Close the cover and reinsert two screws.

Install Keypad and Battery

1. Undo the screw on the bottom side of the keypad.
2. Remove the back cover.
3. Install a AAA battery (1.5V Alkaline type).
4. Mount the back cover with the mounting accessories.
5. Attach the keypad on the back cover and tighten the screw on the bottom of the keypad.

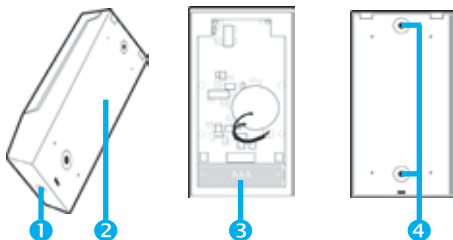

WARNING

To prevent possible serious injury or death:

- Never allow small children near batteries.
- If battery is swallowed, immediately notify doctor.
- Dispose of old battery promptly and properly.

Backup Battery

- 1 Press the latch inwards to release the cover.
- 2 Remove the cover.
- 3 Take out the battery and connect the wires to the battery terminal tabs, being careful to match the polarity.
- 4 Red wire connects to red terminal tab (+).
- 5 Black wire connects to the black terminal tab (-).
- 6 Place the battery back into the battery compartment.
- 7 Close the cover.

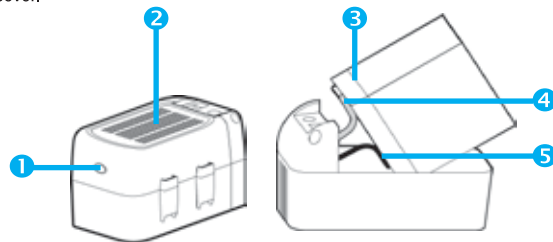

Install the Metal Hanger

- 1 Unplug the garage door opener from power before proceeding.
- 2 Use the screws and nuts to mount the metal hanger to the operator mounting plate.
- 3 Affix a cushion at the side of the hanger.
- 4 Install the backup battery unit to the metal hanger.

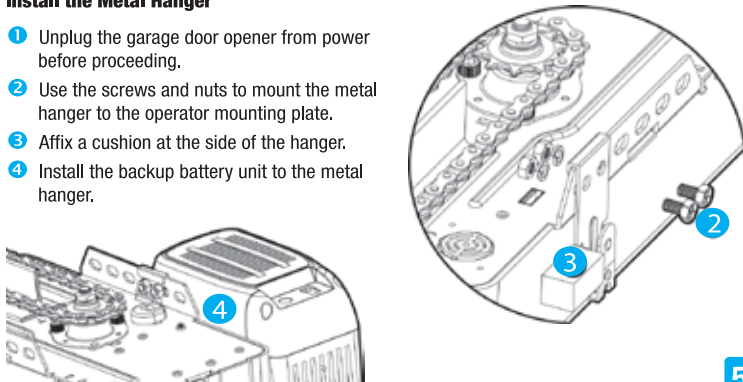

BACKUP BATTERY

NOTE

- These steps must be performed in this exact order very carefully to prevent a short in the battery by accident.

Connecting the battery backup unit to the garage door opener unit

- 1 Connect the 2-wire harness to the garage door opener unit.
- 2 Insert the 2-wire harness to the battery backup unit.



Testing the Battery

- 1 Turn on the battery backup switch.
- 2 Unplug the garage door opener from the AC power.
- 3 Activate the garage door opener. (The lamp in the garage opener will not light up.)
- 4 Plug the garage door opener back in.

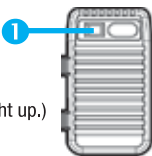

NOTE

- The battery backup must be fully charged for 24 hours before testing or operation.

51

BACKUP BATTERY

Battery Status

Turn on the backup battery switch, and connect the backup battery with the GDO correctly.

LIGHT STATUS	BACKUP BATTERY STATUS	ACTION
Red LED flashing slowly.	Ready to use. Not being charged by the GDO.	Secure the connection between the backup battery and the GDO. Plug the GDO to an AC outlet.
Red LED staying on.	Weak . Not being charged by the GDO.	Secure the connection between the backup battery and the GDO. Plug the GDO to an AC outlet.
Blue LED flashing slowly.	Being charged by the GDO.	Keep charging.
Blue LED staying on.	Fully charged.	Ready to use.
Blue LED flashing quickly and white LED flashing slowly.	Switch is off or the battery is not connected.	Turn on the backup battery switch. Check the connection between the battery and its compartment. Replace the Backup Battery.
White LED staying ON.	Garage door opener is activated with power supply of the backup battery.	The white LED will be delayed off after GDO is no longer activated.

Charging the Battery





- The battery unit will take 24 hours to fully charge. A fully-charged battery provides 24 V DC to the garage door opener for 1 to 2 days of normal operation during AC power outages. When the battery level drops too low, the battery unit will no longer operate.
- Plug the AC adaptor (sold separately) into an AC outlet, then plug the output jack to the battery backup unit to charge it. Refer to the lights indication section above to check the battery status. The battery life is about 1 to 2 years for normal usage.
- To obtain maximum battery life and prevent any damage, turn off the battery backup unit when the garage door opener is unplugged for a long period of time.

NOTE

- Door operation may be limited if the battery is not fully charged, or the Backup Battery light may not turn on during battery operation.

52

TROUBLESHOOTING

LED LIGHT FLASHING	LED DISPLAY FLASHING	SYMPTOM	SOLUTION
3 Flashes		The wall console is in lock mode. The remote controls are deactivated.	<ul style="list-style-type: none"> • Unlock the wall console.
5 Flashes		Obstruction detected.	<ul style="list-style-type: none"> • Check if something obstructing the door. • Re-adjust the travel limits. • Re-adjust the opening and closing force.
10 Flashes		Safety beam sensor blocked.	<ul style="list-style-type: none"> • Check if the safety beam sensor is misaligned. • Check if any obstacle is interfering with the beam path.
15 Flashes		The door is not fully open or fully closed.	<ul style="list-style-type: none"> • Check if something is obstructing the door. • Re-adjust the travel limits. • Re-adjust the opening and closing force.
Continuous Flashing		Wall console wire shorted.	<ul style="list-style-type: none"> • Check the wall console wires for a short.

TROUBLESHOOTING

Opener does not operate from either wall console or remote.	<ul style="list-style-type: none"> • Check the opener's AC outlet has power. Plug a lamp into the outlet to check. If it does not turn on, check fuse box or circuit breaker. • Check the wall console wiring at the wall console's and opener's terminals, and be sure the remote is programmed into the opener.
Opener tries to operate, but the door does not move.	<ul style="list-style-type: none"> • A door spring may have been broken. Visually inspect the door hardware for any broken springs. Have a qualified garage door service professional repair the door if any door hardware is broken. • In cold weather climates, check that the door is not frozen to the ground or that snow build-up is not blocking the door.
Opener operates from remote but not from wall console.	<ul style="list-style-type: none"> • Ensure the wiring connections are correct. • Is the wall console lit? If not, disconnect low voltage wires to wall button and momentarily touch them together. If opener runs, replace wall button. If not, check wiring connections at opener and check wire for shorts or breaks under wire holder.
Opener operates from wall console but not remote.	<ul style="list-style-type: none"> • Is the wall console in lock mode? • Does remote indicator light glow when remote button is pressed? If not, replace the battery. • Has the opener learned the code of the remote? Repeat remote programming steps on pages 33.
Door does not open completely.	<ul style="list-style-type: none"> • Is something obstructing the door? Remove obstructions after ensuring the door area is free of persons and any other objects. • If door has been working properly but now doesn't open all the way, reset the travel limit adjustment. Be sure to run a complete opening and closing cycles to reset the force adjustment as well. Follow instructions on page 34.
Door does not close completely.	<ul style="list-style-type: none"> • Is something obstructing the safety beam sensor? Ensure the receiving beam sensor's LED is on.

TROUBLESHOOTING

Opener light stays on.	<ul style="list-style-type: none">• It is normal for the opener's light to stay on for about 3 minutes after each activation.• If the opener's light was turned on by the light button on the wall console, it will stay on until the light button is pressed again to turn the light off.
Opener activates by itself.	<ul style="list-style-type: none">• Check all remotes programmed into the opener. Check for items pressing on any remote's button.• If a remote has been stolen, erase the opener's memory (refer to page 36) to prevent the lost remote from activating the opener. Reprogram the remaining remotes into the opener (refer to page 35).• Check the wiring between the wall console and the opener. Look for any wire holder that has cut into the wire's insulation, or wire that has been pinched by another object. Replace any bad wiring.• Examine the wiring at the opener's terminals and at the wall console's terminals. Look for any wire strands that are close to or touching adjacent terminals.
Door reverses for no apparent reason.	<ul style="list-style-type: none">• The door hardware may be binding causing the close door force setting to be exceeded. Disengage the trolley and manually check the door movement and balance. Lubricate the door hardware as recommended by the garage door manufacturer.• Re-adjust the travel limits and force adjustments to ensure the automatic force adjustment are set properly.• Ensure the safety beam sensor is securely fastened and no sunlight is shining directly onto the receiving sensor.
Opener is noisy.	<ul style="list-style-type: none">• Adjust the chain tension (refer to page 12).• Lubricate the door hardware as recommended by the garage door manufacturer.
Opener won't work due to power failure.	<ul style="list-style-type: none">• Use the emergency release handle to disconnect the opener from the door. The door can be opened or closed manually until power is restored.

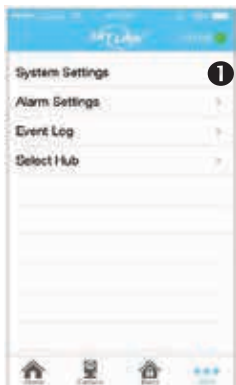

1 Open SkylinkNet App and tap on "System Settings".

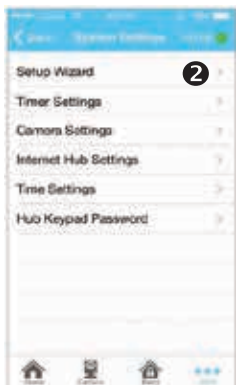

2 Tap on "Set-up Wizard".

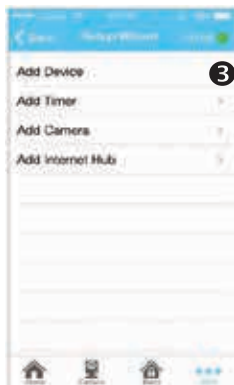

3 Tap on "Add Device".

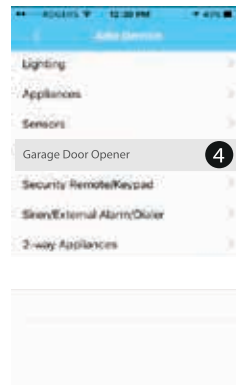

4 Tap on "Garage Door Opener".



5 Name your garage door opener and location and tap on "Continue".



6 On the wall console, press and hold the button for 5 seconds; then, press twice until you see remote icon flashing.



7 On the APP, tap on "Learn Now".



8 Tap on GDO icon to open/close the door. The icon shows the status of the door.



Model MK-318-1
1-Button Remote



Model MK-318-2
2-Button Remote



Model MK-318-3
3-Button Remote



Model WB-550
Wall Console



Model ID-001
Safety Sensor



Model PB-001
Push Button



Model WB-350
Deluxe Console



Model KN-318
Keyless Entry System

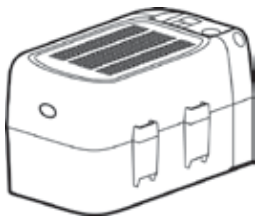

Model BA-100
Backup Battery



Model HU-100
Internet Hub

This device complies with Part 15 of the FCC Rules. Operation is subject to the following two conditions: (1) This device may not cause harmful interference and (2) This device must accept any interference received, including interference that may cause undesired operation.

⚠️ WARNING

Changes or modifications to this unit not expressly approved by the party responsible for compliance could void the user's authority to operate the equipment.

📝 NOTE

This equipment has been tested and found to comply with the limits for a Class B digital device, pursuant to Part 15 of the FCC Rules. These limits are designed to provide reasonable protection against harmful interference in a residential installation. This equipment generates, uses and can radiate radio frequency energy and, if not installed and used in accordance with the instructions, may cause harmful interference to radio communications.

However, there is no guarantee that interference will not occur in a particular installation. If this equipment does cause harmful interference to radio or television reception, which can be determined by turning the equipment off and on, the user is encouraged to try to correct the interference by one or more of the following measures:

- Reorient or relocate the receiving antenna.
- Increase the separation between the equipment and receiver.
- Connect the equipment into an outlet on a circuit different from that to which the receiver is connected.
- Consult the dealer or an experienced radio/TV technician for help.

Skylink Group (the Company) warrants to the original purchaser that products delivered hereunder will be free of defects in material and workmanship for the period listed below from the date of purchase.

Electronics & Mechanical: 1 Year

Motor: Refer to the sales agreement

The Company within said period shall at its option, either repair or replace free of charge, any product or part thereof found, upon the Company's inspection, to be so defective, and will return the repaired or replaced product to the purchaser at Company's expense.

For warranty service and shipping instructions contact 1-800-304-1187. Devices must be sent to the Company at owner's expense and be accompanied with statement of defect and proof of purchase.

This warranty is conditioned on the following:

1. The Company must be notified within the period of the warranty from the date of purchase and have been given the opportunity of inspection by return of any alleged defective product free and clear of all liens and encumbrances to the Company or its distributor; and
2. The product must not have been abused, misused or improperly maintained and/or repaired during such period; and
3. Such defect has not been caused by corrosion or exposure to other than ordinary wear and tear.

THE COMPANY MAKES NO OTHER WARRANTY OR REPRESENTATION OF ANY KIND WHATSOEVER EXPRESS OR IMPLIED, AND ALL IMPLIED WARRANTIES INCLUDING ANY WARRANTY OF MERCHANTABILITY OR FITNESS FOR A PARTICULAR PURPOSE ARE HEREBY DISCLAIMED.

The Company's maximum liability hereunder is limited to the purchased price of the product. In no event shall the Company be liable for any consequential, indirect, incidental or special damages of any nature arising from the sale or use of the product, whether based in contract, tort, strict liability or otherwise.

Some states do not allow limitations on incidental or consequential damages or how long an implied warranty lasts so that the above limitations may not fully apply. This warranty gives specific legal rights and you may also have other rights which may vary from state to state.



MONDAY-FRIDAY



9:00 AM - 5:00 PM EST



1-800-304-1187



support@skylinkhome.com



SKYLINKHOME.COM

