

CARE AND MAINTENANCE

1. Use a soft, clean cloth that will not scratch the surface while cleaning.
2. Using solvents of any kind on your product may damage the finish.
3. Do not use any harsh abrasives or chemicals to clean any metal surface as it may damage the protective coating.

LIMITED LIFETIME WARRANTY

This product is warranted to the original purchaser. If there is a failure in this unit due to defects in materials or workmanship, the manufacturer will repair or replace this item at our discretion without charge. Warranty is void if product has been assembled incorrectly, misused, abused by overloading, altered in any way or damaged due to accident. This warranty is not transferable and does not cover chipping, flaking, scratches, rust, dents, or other damages to the surfaces of this product. Responsibility of the manufacturer is limited to repair or replacement of this product. The manufacturer is not responsible for consequential, incidental, or other damages or losses resulting from product failure.

This warranty is in lieu of all other expressed warranties. Some states do not allow the exclusion or limitation of incidental or consequential damages, therefore, the above limitation may not apply to you. This warranty gives you specific legal rights and you may have other rights which vary from state-to-state.

46" Industrial Metal & Wood Work Table

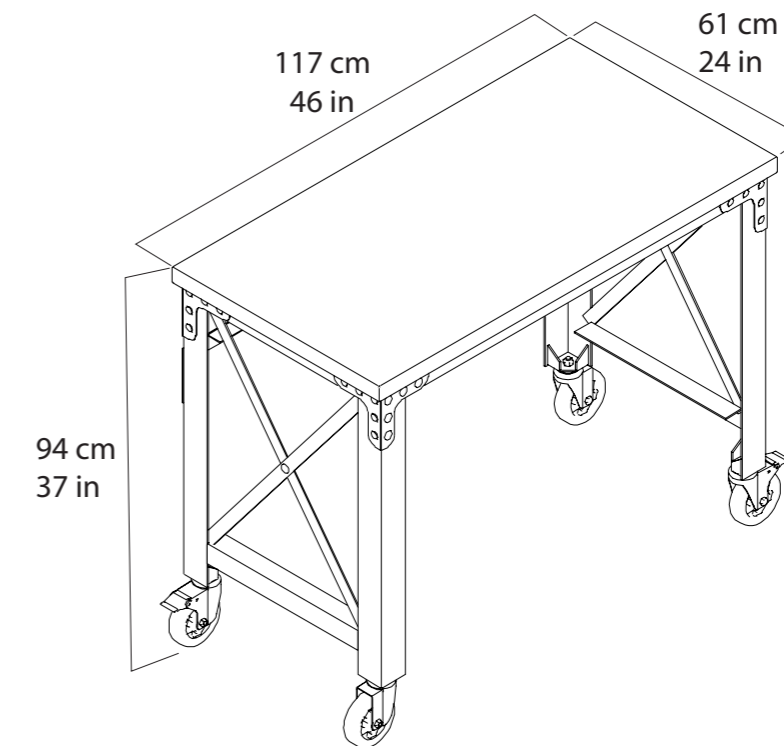

IMPORTANT: READ CAREFULLY AND RETAIN FOR FUTURE REFERENCE



WARNING

Your safety and the safety of others is important to us.
Failure to follow these guidelines can result in property damage or personal injury.

- The product is for indoor use only (Not recommended for outdoor use).
- We strongly recommend that at least two or more adults move and assemble this unit.
- Please ensure that all steps are completed before fully tightening the bolts.

Load Capacity

Top: 150 kg / 330 lb

Entire Unit Maximum Capacity: 453 kg / 998 lb

PARTS

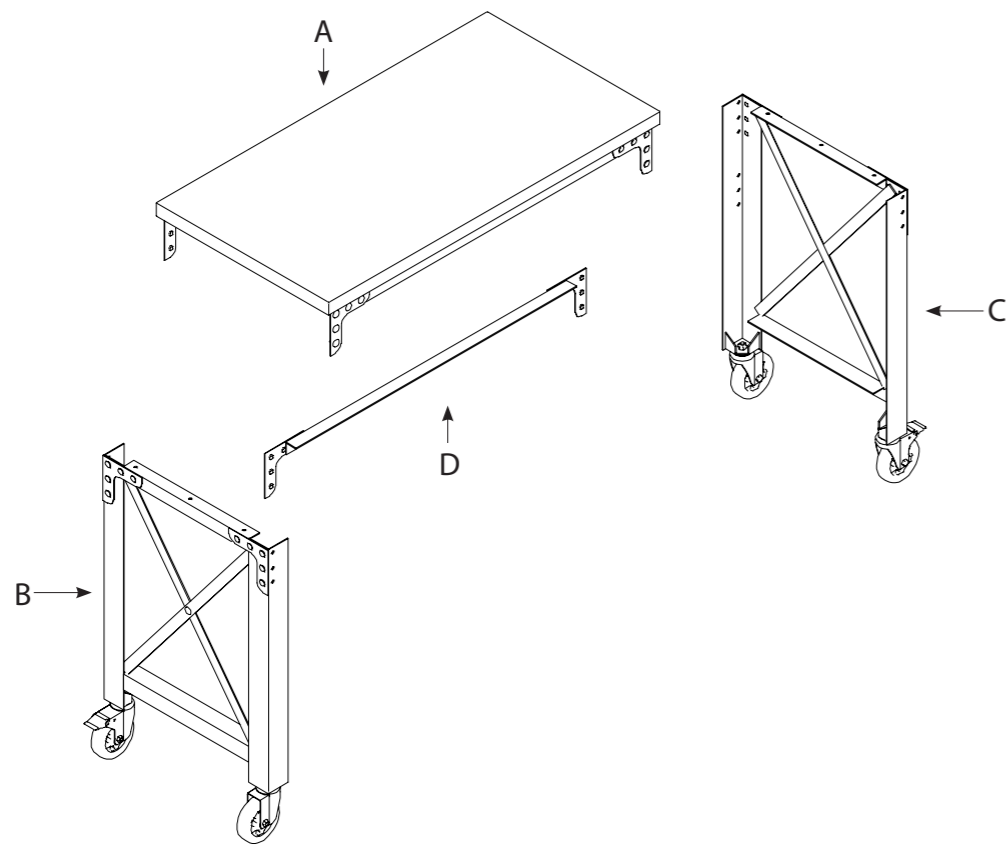

PARTS LIST

A x 1 Top		E x 18 Carriage Bolt	
B x 1 Left Side Frame		F x 18 Lock Washer	
C x 1 Right Side Frame		G x 18 Hex Nut	
D x 1 Upper Beam		H x 6 Screw	

Tools Required (Not Included)

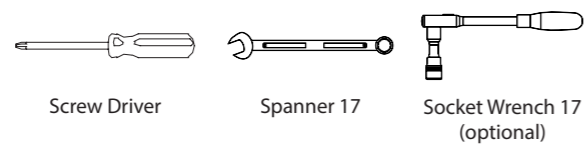

ASSEMBLY INSTRUCTIONS

Step 1

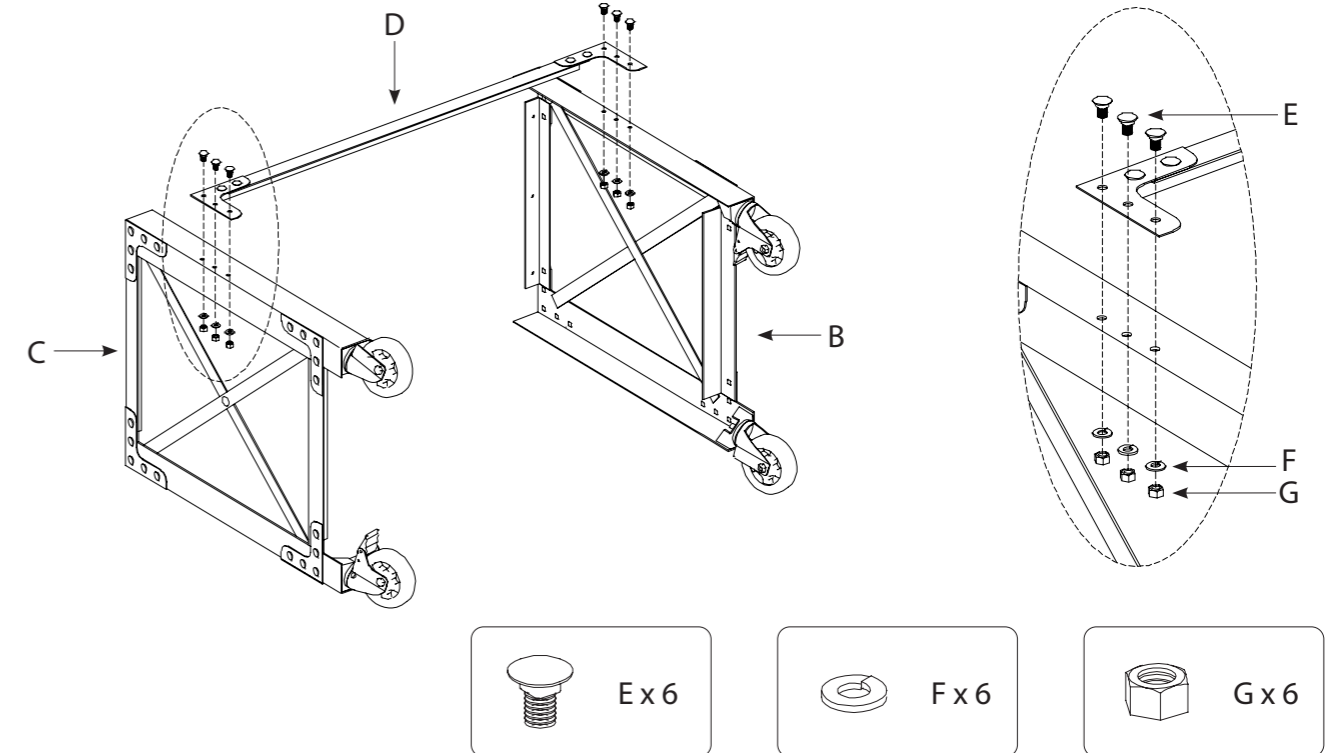

Step 2

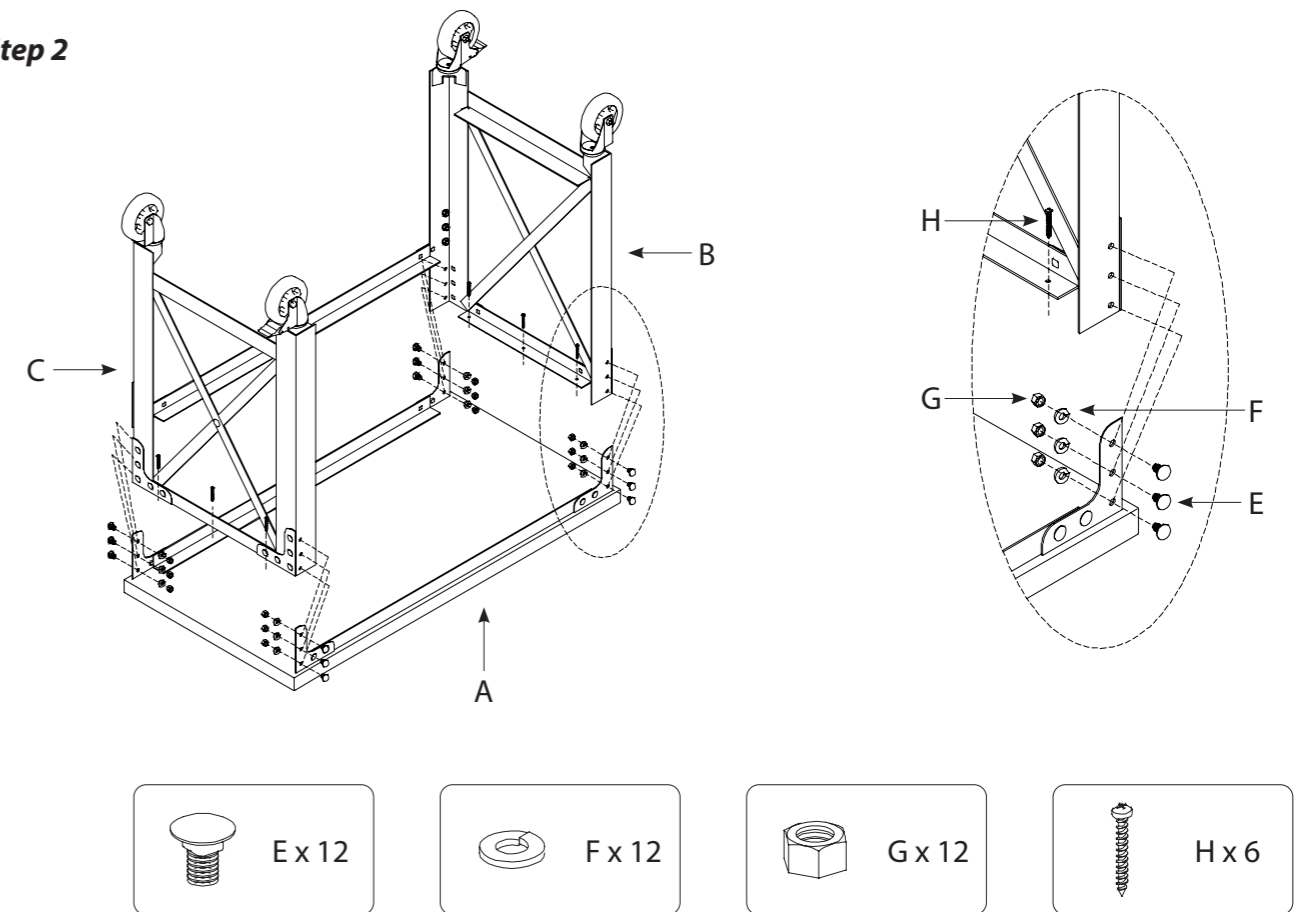

Note: Assemble upside down according to instructions.
Ensure the wood table top is flat on the floor.
To protect the wood table top, we recommend to place top on cardboard.