

# dyson ball animal

Dyson ball  
animal logo

SV12 JN.00000 PN.000000-00-00  
00.00.00 VERSION NO.01

## User manual

The Dyson upright  
vacuum cleaner  
front view with  
the cleaner head,  
ball, bin and  
handle attached.

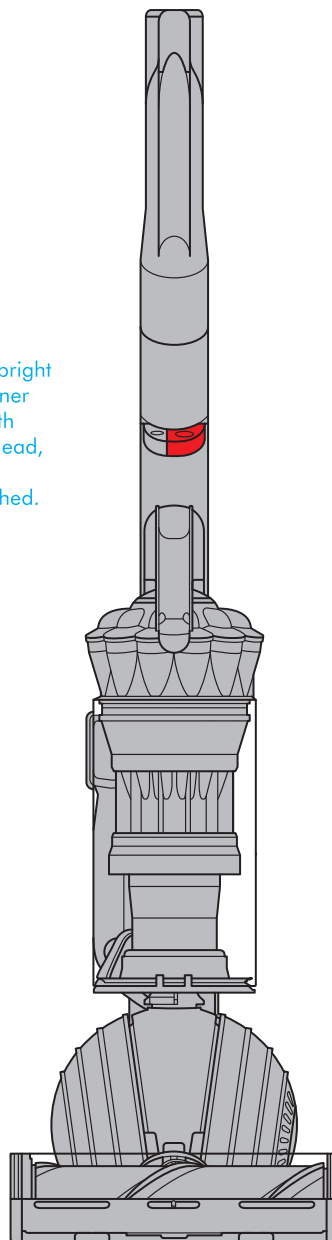

---

In the box  
Getting started  
Assembling your machine  
Caring for your floors  
Using your Motorbar™ cleaner head  
Using your tools  
Emptying your bin

Storing your machine  
Clearing blockages  
Clearing obstructions from your  
Motorbar™ cleaner head  
Washing your filters  
Looking after your machine

# In the box

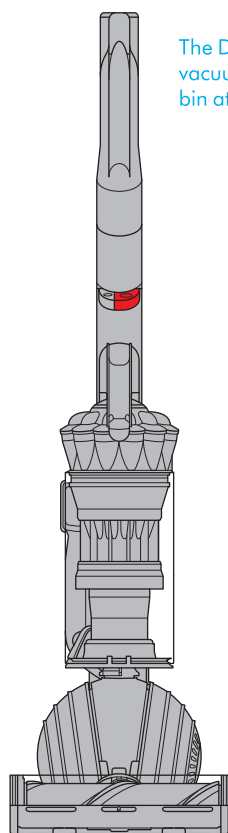

The Dyson upright vacuum cleaner with bin attached.

Vacuum cleaner

A brush bar located inside the cleaner head and a suction control slider located on the front.

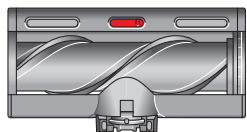

Motorbar™ cleaner head

The handle supplied separately, with a triangular handle grip and cable clip on the front.

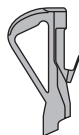

Handle

A plastic clip that can be fitted behind the bin to hold the combination tool.



Tool holder



Wand

Some tools and accessories may not be included.

You can buy additional tools and accessories at [www.dyson.com](http://www.dyson.com).



This tool has a combination of brush head and crevice tool together in one unit. The brush head slides down the crevice tool when needed.

**Combination tool**  
Two tools in one - brush and nozzle, for versatile cleaning around your home.

A wide mouth tool with a lint edge.

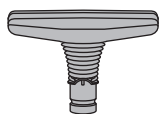

**Stair tool**  
For vacuuming narrow or difficult-to-reach carpeted areas, such as stairs and corners.

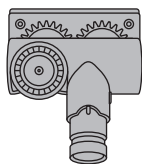

**Tangle-free turbine tool**  
Counter-rotating brush heads remove hair from carpets and upholstery. No tangles.

Soft bristles are on the underside of this tool.



**Soft dusting brush**  
Enclosed in a skirt of soft nylon bristles for gentle, vacuum-assisted dusting of delicate objects and surfaces.

A wide, triangular shaped nozzle.

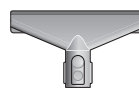

**Fabric and mattress tool**  
Removes dust, dirt and allergens from mattresses and upholstery.

A long rectangular tool with a jointed connection and soft bristles on the underside.

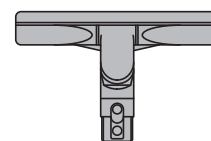

**Articulating hard floor tool**  
Swivelling brush head with an ultra-slim profile to reach difficult spaces. With soft nylon bristles to remove dust and allergens.

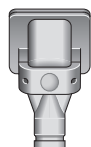

A spring-loaded head with metal bristles on the underside.

**Pet groom tool**  
Captures loose hair and dander as you brush your pet. Flexible bristles self-clean in an instant.

A small cleaner head with a body housing the motor and an electrical connector to attach to the wand or directly to the machine.

# Getting started

Hand holding handle of the Dyson upright vacuum cleaner.



**Lean to clean**  
Lean handle back to start a clean. Leave upright to direct suction to the wand.

Two buttons are located between the handle and the handle of the bin. The power button is on the right.

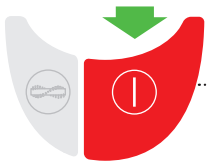

**Power button**  
Press the power button to start cleaning.

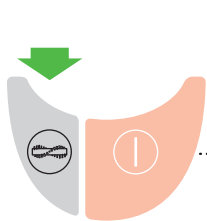

**Brush bar control**  
Turn off the brush bar for delicate floors or deep pile rugs.

Two buttons are located between the handle and the handle of the bin. The brush bar control button is on the left.

**Ball technology**  
Easy to maneuver. Steers around furniture with a gentle turn of the wrist.

The ball located between the bin and the cleaner head.

**Motorbar™ cleaner head**  
De-tangling vanes automatically clear wrapped hair from the brush bar as you clean.

Dyson cleaner head containing a cylindrical brush bar with slide bar on the middle at the front is at the base of the machine.

**High-reach wand with quick release**

The hose and wand release in one action for easy tool changes.

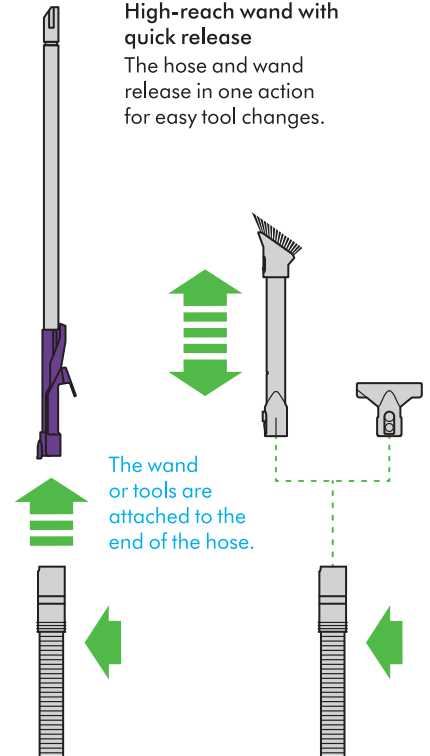

The wand or tools are attached to the end of the hose.

The suction control slider is located at the front of the cleaner head.

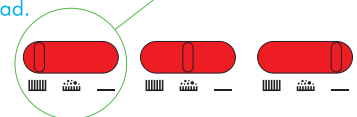
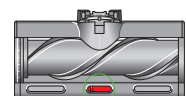

**3 cleaning modes**

Adjust the slider for the right suction for the right task: deep- and medium-pile carpets, low-pile carpets and large debris, and hard floors and ground-in dirt.

# Assembling your machine

## Fit the cleaner head

Lay your machine on its back.

Slide your Motorbar™ cleaner head into position on the front of the ball. Push upwards until the red button on the underside of your machine clicks securely in place.

Stand your machine upright.

An arrow shows the position in which the cleaner head is placed. An audible sound is shown making a click.

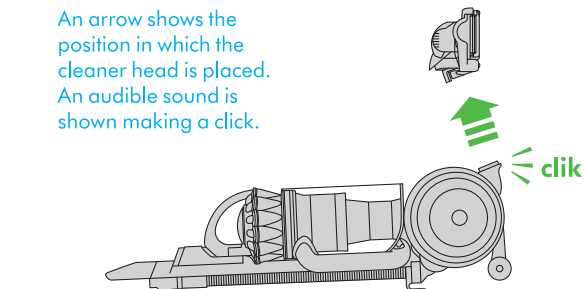

## Fit the wand

Slide the handle onto your machine until it clicks into position.

Position the wand into the end of the hose. Press the wand release button on the end of the hose and slide the wand all the way down.

Position the wand and hose in the handle recess on your machine. Slide the wand down into the handle until it clicks into position.

Close the wand end cap.

The wand is clicked back onto the hose. And pushed back into the machine.

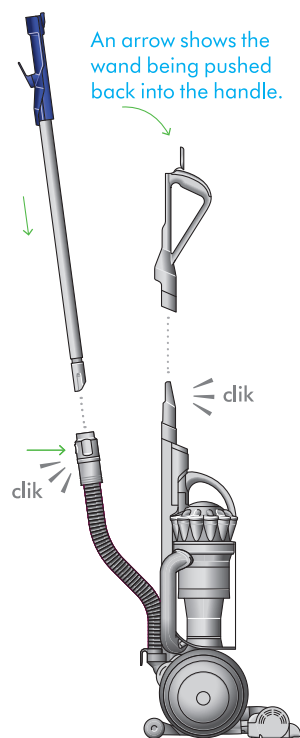

## Fit the tool holder

Slide the tool holder into position on the side of your machine.

Fit your combination tool onto the holder.

The tool holder is attached to the machine just below the handle.

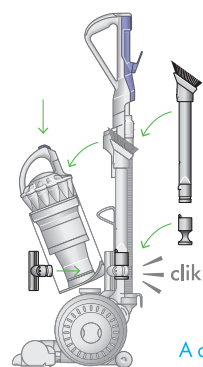

A combination tool is attached to the tool holder.

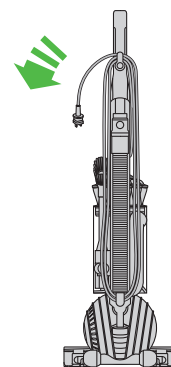

Wrap the cable around the top and bottom cable hooks and secure with the cable clip.

# Caring for your floors

Check that the underside of the cleaner head or tool is clean and free from any objects that may cause damage.

Before vacuuming your flooring, rugs, and carpets, check the manufacturer's recommended cleaning instructions.

The brush bar on your machine can damage certain flooring. Some rug materials may fuzz if a rotating brush bar is used when vacuuming. If this happens, we recommend vacuuming without the motorized floor tool and consulting with your flooring manufacturer.

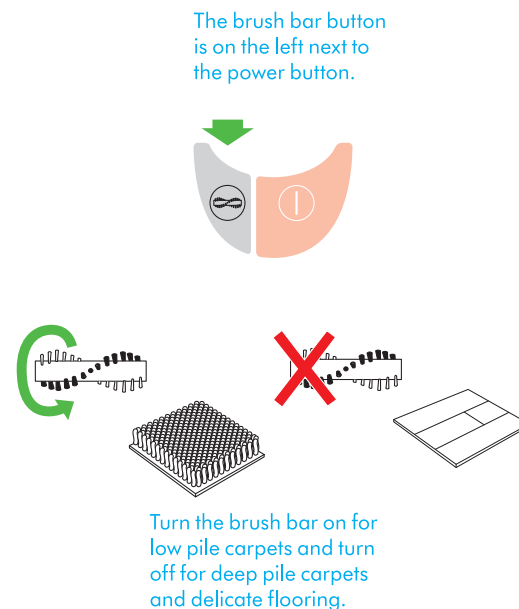

## Using your Motorbar™ cleaner head

Your cleaner head has a motor-driven brush bar with suction control.

Check the manufacturer's recommended cleaning instructions for your flooring type.

Slide the suction control to suit your floor type. Select the right cleaning mode for the right task.

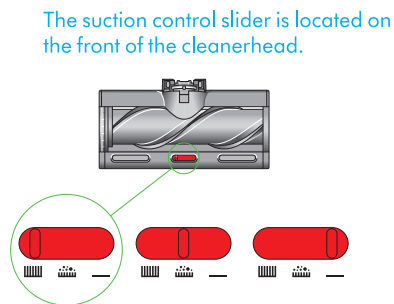

Position the slider to the left for use on deep- to medium-pile carpets, delicate flooring and rugs.

Position the slider in the center for low-pile carpets and large debris.

Position the slider to the right for hard floors and ground in dirt.

If your machine is hard to push, use the mode on the left.



# Using your tools

## Attach to the wand

Open the cap on the handle and slide the wand upwards until both the wand and hose release from the machine.

Push the tool into the end of the wand.

## Remove from the wand

Remove the tool and slide the wand back into the hose. Position the wand and hose in the recess on the handle of your machine.

## Attach to the hose

Open the cap on the handle and slide the wand upwards until both the wand and hose release from the machine.

Press the button on the end of the hose to release the wand.

Fit the tool into the end of the hose.

## Remove from the hose

Remove the tool from the end of the hose.

Push the wand into the end of the hose until it clicks into position.

Slide the wand down into the hose.

Close the wand end cap.

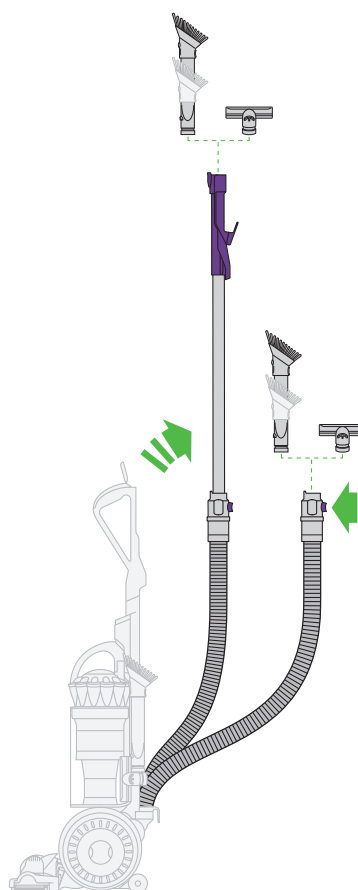

Use the tools attached to the wand or hose to clean stairs with the machine placed at the bottom of the stairs.

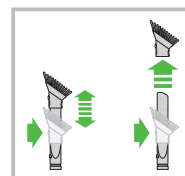
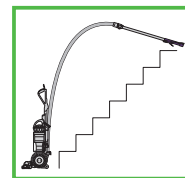

To use the combination tool, press the button on the tool and slide the brush down the crevice tool.

# Emptying your bin

Empty as soon as the dirt reaches the MAX level – don't overfill. Using your machine when the dirt is above the MAX line may affect the performance and require more frequent filter washing.

## Remove your bin

Turn off and unplug your machine.

Press the button on the bin handle to detach the bin from your machine.

## Release the dirt

Hold your bin, with the bin base pointing down, over your trash can.

Firmly push the button on the bin handle, until the bin base opens.

## Minimize dust contact

Cover your bin tightly in a dustproof bag while you empty. Remove your bin carefully, seal the bag tightly and dispose.

## Replace your bin

Push the bin base up until it closes, clicking into place.

Position the bottom of your bin on your vacuum cleaner and then push the top into your machine until it clicks securely into place.

The bin release button is located on the handle of the bin.

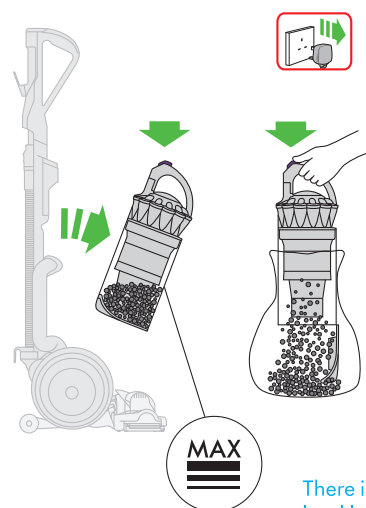

There is a max level located approximately half way up the bin.

# Storing your machine

Carry your machine using the bin handle.

Push your handle into the upright position.

Push your handle firmly forward and listen for two clicks to lock in upright position.

The stabiliser wheels will drop into position when the handle is locked in the upright position.

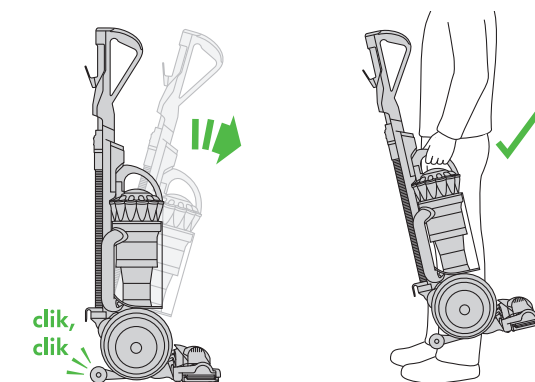

# Clearing blockages

If any part of your machine becomes blocked, it may automatically cut out and the power will stop.

Unplug and leave your machine to cool before checking for blockages.

## Remove cleaner head

Lay your machine on its back.

Push down the red button on the bottom of the ball and then slide your cleaner head down and off your machine.



The button to release the cleaner head is located at the back of the machine between the ball and cleaner head.

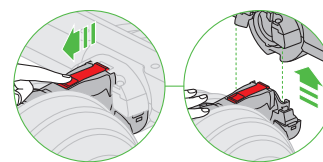

Press down on the top of the button to release the cleaner head. Pull the cleaner head upwards to remove it from your machine.

## Check the wand

Open the cap on the handle and slide the wand upwards until both the wand and hose release from the machine.

Press the button on the end of the hose to release the wand.

Look through the wand to check for blockages.

You should check for blockages in a number of locations on your machine, the wand and hose and the cleaner head and airways.

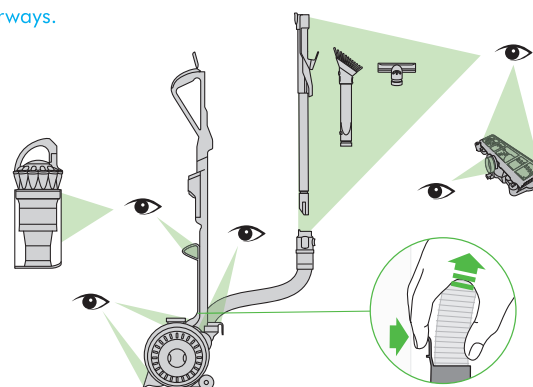

## Check the hose

Open the cap on the handle and slide the wand upwards until both the wand and hose release from the machine.

Press the button on the end of the hose and remove the wand.

Press the button on the bin handle and remove the bin. Press the tab on the base of the hose to remove it from your machine.

Check for blockages in the hose, be careful of any sharp objects.

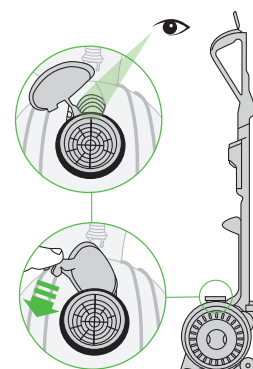

## Check airways for blockages

Recline your machine and remove the outer cover of the ball.

Press the button on the handle of the bin and lift it away from your machine. Locate the clear inspection panel at the bottom of the bin recess on your machine and lift it to one side. Remove any debris.

Remove the cleaner head and look for blockages in the airway.

Check all the airways, removing any debris before reassembling your machine.

The cuff is located at the back of the machine, just above the ball.

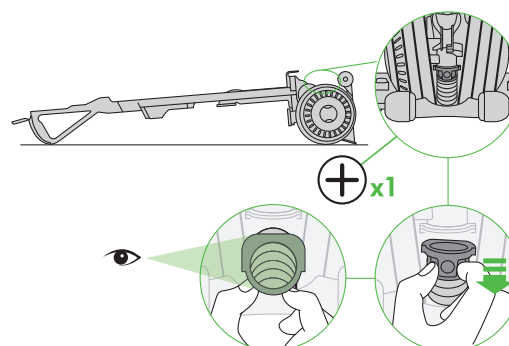



# Clearing obstructions from your Motorbar™ cleaner head

Your Motorbar™ cleaner head doesn't have a washable brush bar. To maintain optimum performance, check your brush bar regularly and clear any obstructions.

Unplug and leave your machine to cool before checking for blockages.



## Remove cleaner head

Lie your machine on its back.

Push down the red button on the bottom of the ball and then slide your cleaner head down and off your machine.

The button to release the cleaner head is located at the back of the machine between the ball and cleaner head.

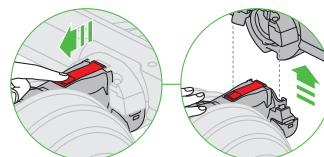

Press down on the top of the button to release the cleaner head. Pull the cleaner head upwards to remove it from your machine.

## Remove your brush bar

Press the button on the back of the Motorbar™ cleaner head and push upwards 90° to release the end cap.

Pull the brush bar out of the cleaner head.

Remove any hair, thread or debris from around the brush bar.

Be careful of any sharp objects when clearing blockages.

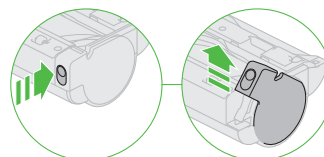

The brush bar release button is located at the back of the cleaner head.

## Replace your brush bar

Push the brush bar firmly back into the cleaner head.

Make sure the brush bar is pushed fully into the cleaner head. Rotate the end cap until it clicks back into the locked position.

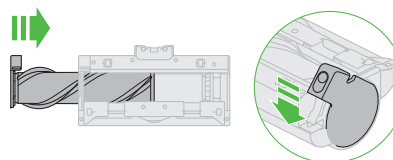

## Reassemble the cleaner head

Slide your Motorbar™ cleaner head into position on the front of the ball. Push upwards until the red button on the underside of your machine clicks securely in place.

# Washing your filters

Wash your filters at least once a month to maintain optimum suction power.

For more information and support videos for your machine go online:  
[www.dyson.com/support](http://www.dyson.com/support)

## Washing filter A

### Remove your filter

Press the button on the bin handle to detach the bin from your machine.

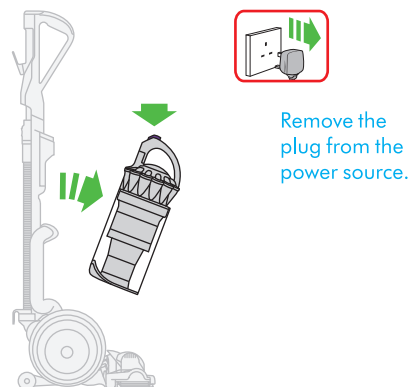

### Wash your filter

Push up the catch on the front of the bin handle and lift out the filter.

Only wash the filter with cold water. Hold the open end of the filter under a running tap, until the water runs clear.

Turn the filter upside down and tap to remove excess water.

Run water over the outside of the filter until the water runs clear.

Squeeze and twist with both hands to make sure the excess water is removed.

The clip to open the top of the cyclone can be found where the bin handle joins the cyclone.



With the handle lifted up, the filter can be located in the center of the cyclone unit.

### Dry your filter

Squeeze the excess water out of your filter.

Leave your filter to dry for at least 24 hours in a well-ventilated, warm place.

Don't dry your filter in a tumble dryer, microwave or near a naked flame.

Important: your filter must be completely dry before you put it back into the machine. Your machine could be damaged if used with a damp filter.

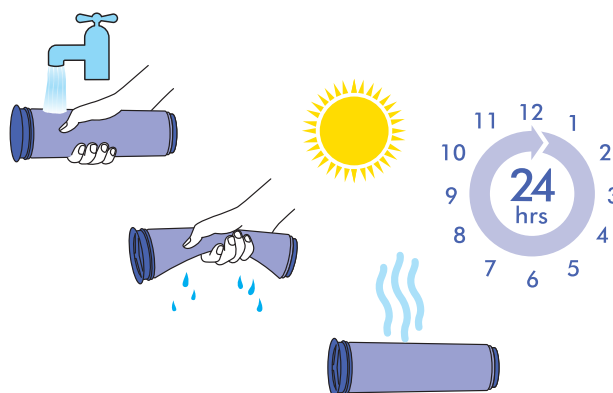

### Reassemble your filter

Drop your filter back into your machine. Close the handle and make sure it clips into place.

Place the base of your bin onto your machine and then push the top into position until it clicks.

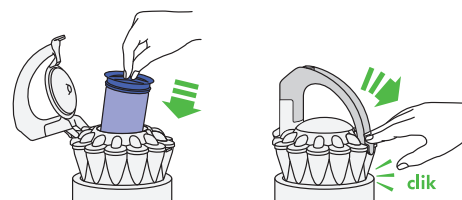

The filter should be dropped back into the center of the cyclone unit and the handle pushed down into position with a click.

# Washing filter B

## Remove your filter

Lay your machine on its side with the filter cover facing upwards.

Turn the lock in the center of the ball until the filter cover is released. Lift off the filter cover.

Twist the filter counter-clockwise until it is released and lift it off your machine.

Remove the plug from the power source.

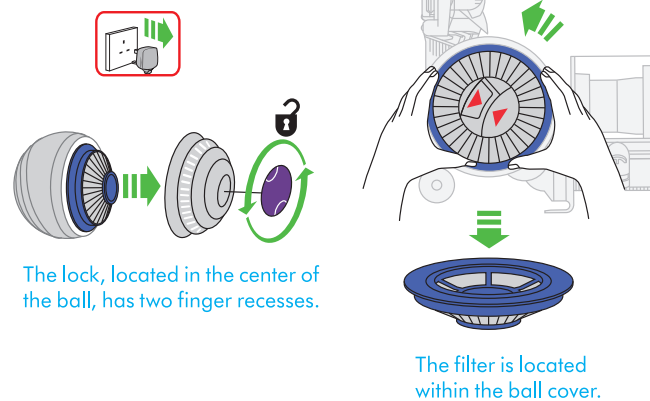

## Wash your filter

Wash the filter in a rotating motion.

Repeat until the water runs clear.

Tap the filter to remove excess water.

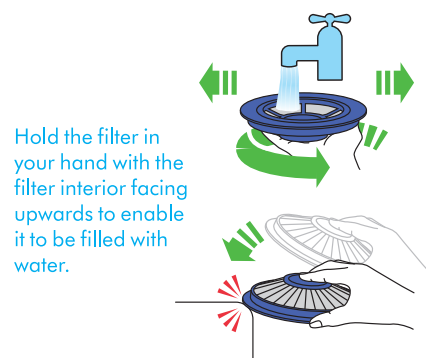

## Dry your filter

Leave your filter to dry for at least 24 hours in a well-ventilated, warm place.

Don't dry your filter in a tumble dryer, microwave or near a naked flame.

Important: your filter must be completely dry before you put it back into the machine. Your machine could be damaged if used with a damp filter.

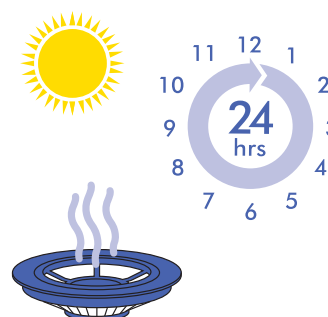

## Reassemble your filter

Place the filter back into position in the ball.

Twist the filter clockwise until it clicks into position.

Refit the filter cover and turn the lock until it clicks securely into the closed position.

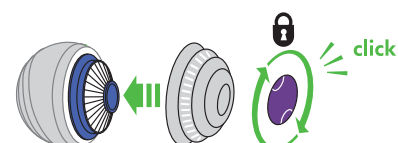
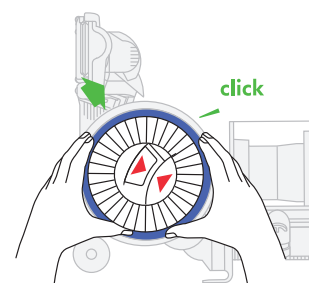

# Looking after your machine

To always get the best performance from your machine, it's important to clean it regularly and check for blockages.

## **Look after your machine**

If your machine is dusty, wipe with a damp lint-free cloth.

Check for blockages in the cleaner head, tools and main body of your machine.

Wash your filter regularly and leave to dry completely.

Don't use detergents or polishes to clean your machine.

## **Your serial number**

You can find your serial number on your machine, behind the bin. Use your serial number to register your machine.