

MODEL: 51035BLSL

PACKING DIAGRAM

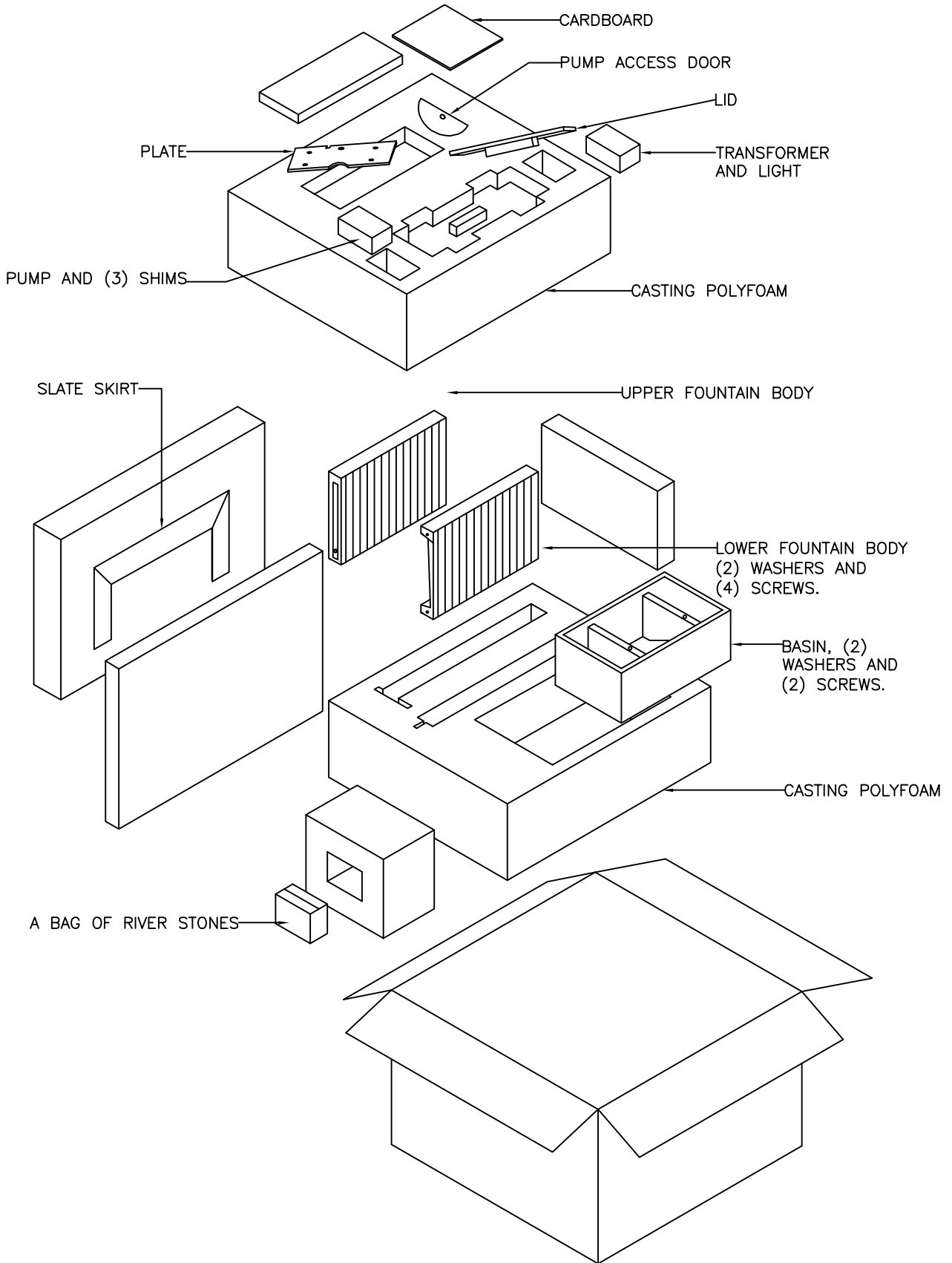









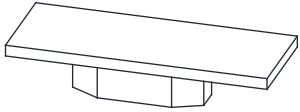

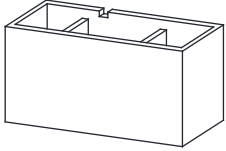
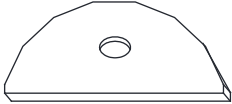

KenroyHome

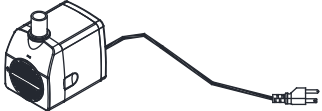
51035BLSL
Parts List

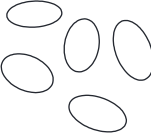

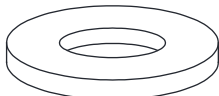
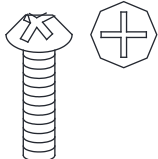
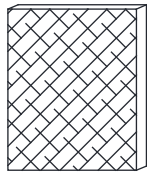
You should have received the following parts in the package. Please ensure that all parts are accounted for.

<p>A LID</p>	<p>B UPPER FOUNTAIN BODY</p>	<p>C LOWER FOUNTAIN BODY</p>	<p>D PLATE</p>
			
<p>1 PC</p>	<p>1 PC</p>	<p>1 PC</p>	<p>1 PC</p>
<p>E BASIN</p>	<p>F PUMP ACCESS DOOR</p>	<p>G SLATE SKIRT</p>	<p>H PUMP</p>
			 REPLACEMENT PART: PUMP1750
<p>1 PC</p>	<p>1 PC</p>	<p>1 PC</p>	<p>1 PC</p>
<p>I LIGHT TRANSFORMER & SWITCH</p>	<p>J LIGHT</p>	<p>K DECORATIVE RIVER STONES</p>	<p>L SHIMS</p>
 REPLACEMENT PART: LTAS2001	 REPLACEMENT PART: LTAS2001		
<p>1 PC</p>	<p>1 PC</p>	<p>1 BAG</p>	<p>3 PC</p>
<p>M METAL WASHERS</p>	<p>N SCREWS</p>	<p>O WATER GUIDING PAD</p>	<p>P METAL CARD</p>
 Shown To Scale	 Shown To Scale		
<p>4 PC</p>	<p>4 PC</p>	<p>1 PC</p>	<p>1 PC</p>

KenroyHome

ALLUVIUM FLOOR FOUNTAIN

Care and Instruction Manual



51035BLSL ASSEMBLY INSTRUCTIONS

Thank you for purchasing a Kenroy Home water feature, you are now only minutes away from filling your home or outdoor living space with peaceful displays. Our guarantee backs all of our water features, please do not hesitate to contact our Customer Support Team for resolutions to any parts or installation concerns.



KenroyHome

CUSTOMER SUPPORT TEAM

For any additional questions or concerns please contact our Customer Support Team:

 **904-642-4340**

 **@KenroyHome**

 **customerorders@kenroyhome.com**

51035BLSL ASSEMBLY INSTRUCTIONS

Please reference the separate parts list and ensure that all pieces are included in the package prior to assembly.

SUGGESTED TOOLS

NOT SUPPLIED

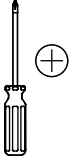

PHILLIPS
SCREWDRIVER



More than one person may be required to complete the assembly of this product.



To protect the finish, place all parts on a soft surface when unpacking.



We recommend using this fountain against a wall.



When assembling ensure that all parts are firmly tightened.

Choose a location:

We recommend using this freestanding water feature against a wall.

This water feature is designed for outdoor use. It can be used indoors, however splashing may occur.

Also consider the location of your power source. The pump has a 10' cord and should be connected to a grounded 110V outlet.

For best results the water feature should be placed on a firm, level surface.

1

51035BLSL ASSEMBLY INSTRUCTIONS

Unscrew parts 4 x N and 4 x M from lower fountain body (C) and basin (E).

Use 2 x M and 2 x N to secure plate (D) to lower fountain body (C).

2

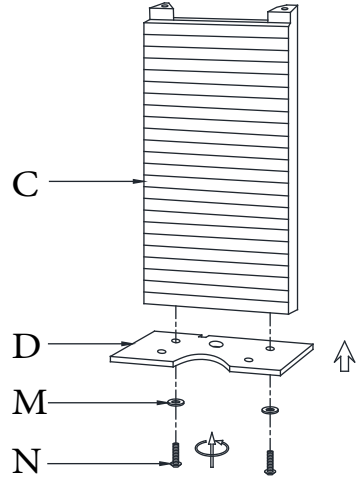
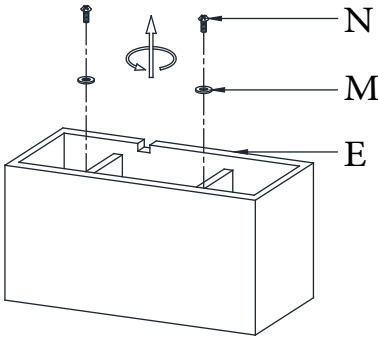

Loosen two screws in top of fountain body (C). Insert pins into holes, and then tighten the two screws.

3

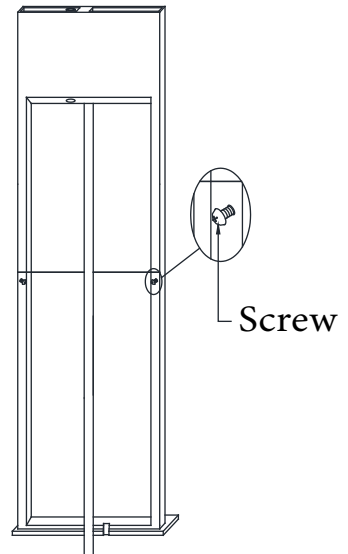
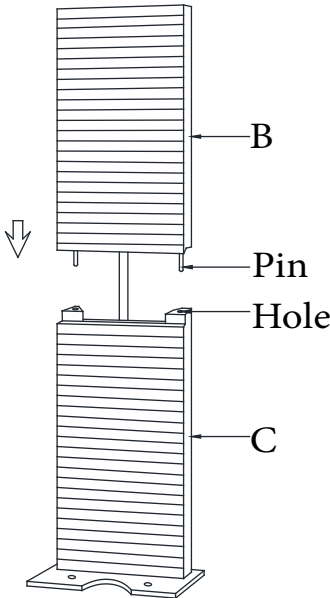

51035BLSL ASSEMBLY INSTRUCTIONS

Feed rubber hose through hole and attach pump (H) to rubber hose.

Run pump cord through notch in back of basin (E), use 2 x M and 2 x N to secure the fountain body assembly (C) to basin (E).

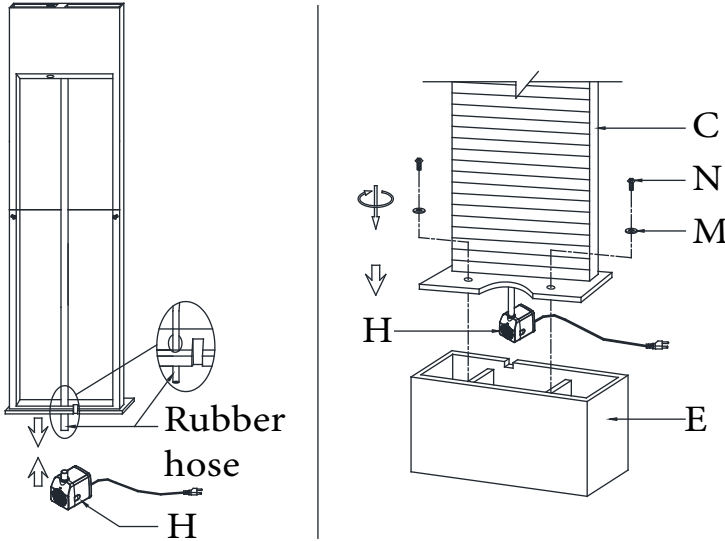

Feed light cord (J) through plastic tube, insert light (J) into bulb clip.

Place lid (A) onto upper fountain body (B).

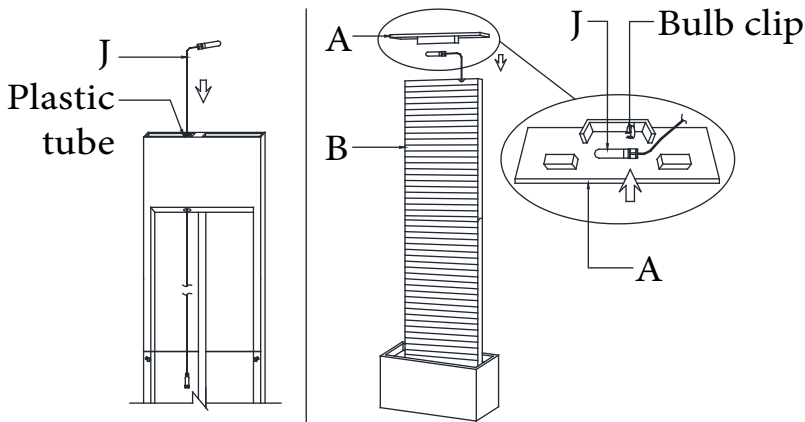







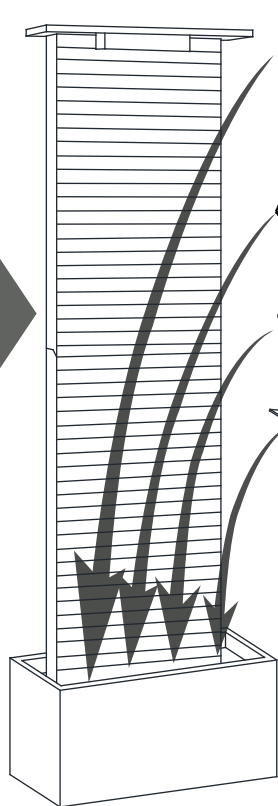

51035BLSL ASSEMBLY INSTRUCTIONS

6

FINAL STEPS



-  Fill the basin (E) with 2.5 gallons of distilled water, between the fill lines.
-  Place pump access door (F) into basin (E).
-  Place decorative river stones (K) onto basin (E).
-  Place slate skirt (G) onto basin (E).
-  Connect the light connectors (I) and (J) and screw the cap tightly.
-  Plug light transformer (I) and pump (H) into outlets and turn light on at switch.
-  Use shims (L) to level the fountain as necessary.
-  Use water guiding pad (O) to brush the fountain face.
-  Use metal card (P) to clear water exit if necessary.

Note: Light does not have to be on to operate pump.

51035BLSL ASSEMBLY INSTRUCTIONS

PUMP SAFETY & TROUBLESHOOTING

To clean the pump

Unplug the pump from the electrical outlet. Use a small soft brush or place it under a water stream to remove debris.

To keep water clean

Periodically change water to prevent algae buildup.

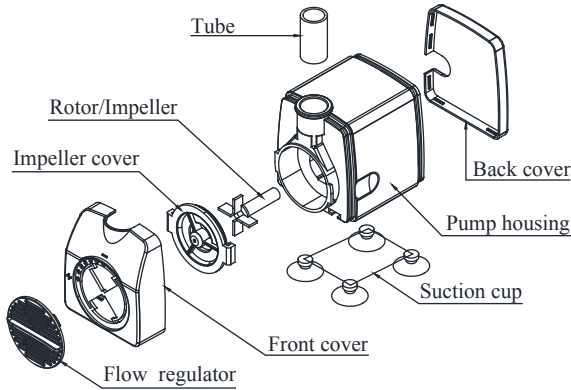

If the pump fails to run:

- Check circuit breaker, or try a different outlet.
- Check tubing for kinks and obstructions.
- Clean out any algae buildup.
- Remove the front cover & impeller cover to access the impeller area. Turn the rotor to ensure it is not broken or jammed.

With low flow rate, the pump will spew or “burp”:

- Check the water level to make sure the pump is completely submerged, water should always be above the min fill line (not all water features include min fill line).

If abnormal noise is heard during operation (with water):

- Disconnect the power supply and then remove the pump front cover and impeller cover.
- Use hand to grip the impeller, gently pull the impeller/rotor assembly out of the pump housing.
- Rinse the impeller/rotor assembly and the cavity with clean water. If breakage or surface damage is found in the assembly contact Customer Service for a part replacement.

51035BLSL ASSEMBLY INSTRUCTIONS

WATER FEATURE WARNINGS & TROUBLESHOOTING

- Splashing may occur when the fountain is first turned on, protect surrounding surfaces as needed. Do not place the water feature on or near any surface that can be damaged by water. 
- Distilled water is recommended to reduce mineral deposits, bacteria build up and algae that may damage the water feature basin and pump.
- To reduce the risk of electrical shock, always disconnect the power supply before working with the water feature.
- Keep small children and pets away from the water feature; they can fall into the water feature and drown.
- Once a week inspect water feature, floor and adjacent wall for moisture build-up and clean as necessary. This is especially important for humid environments.
- *This water feature is designed for outdoor use. It can be used indoors, however splashing may occur.*

More information about water features can be found at [youtube.com/kenroyhomefountains](https://www.youtube.com/kenroyhomefountains).

51035BLSL ASSEMBLY INSTRUCTIONS

FREQUENTLY ASKED QUESTIONS

What should I consider when selecting a water feature?

In addition to your personal style tastes, be sure you have an area for your water feature that can be safely exposed to water, as splashing can occur. Also take into consideration what a water feature can add to your environment: the sound of flowing water or decorative lights.

Can my water feature be left outside over winter?

This water feature is rated for outdoor use; however certain weather conditions may adversely affect your water feature. If the temperature in your region is at risk of dropping below 33° F, your water feature should be “winterized” before the cold weather arrives. To winterize:

1. Fully drain your water feature of all water.
2. Disconnect the hoses, pumps, and lights.
3. Clean all components thoroughly, paying special attention to the pump to prevent residue build-up.
4. Allow all parts to dry.
5. Store parts and water feature in a safe, weather-free environment.

What kind of water should I use in my water feature?

The best water for your water feature is distilled water. This can help prevent and reduce bacteria and algae buildup. If you do not use distilled water, more maintenance will be necessary to keep the water feature clean.

How do I clean my water feature?

Oils, dirt, and algae can all build up on the water feature over time. The best way to restore your water feature to its original state is to empty all the water from the water feature and use a mild soap (like dish detergent) and an acrylic brush to clean all the parts.

51035BLSL ASSEMBLY INSTRUCTIONS

FREQUENTLY ASKED QUESTIONS CONTINUED

How much water do I need to keep in the water feature?

Where possible in our water features, we have included fill lines to help you visualize the water level required for proper function. If your water feature does not include fill lines, please check the instruction manual for water capacity. The most important aspect to keeping your water feature functioning is to insure the pump is submerged in water at all times to prevent damage to the pump.

How often will I need to fill my water feature?

Over time, the water level in your water feature will recede. This is due to evaporation, and the speed at which your water feature will need to be filled depends greatly on your environment- the humidity, if your water feature is in the sun, how often you run the water feature, etc. We recommend checking the water level before running the water feature to insure the pump is submerged in water.

I cannot find my installation instructions. Where can I find another copy? Installation and assembly instructions can be found online at www.kenroyhome.com

Can lights be turned off separately from the water feature?

Water features that include lights will have a separate plug and switch for the lights. They do not have to be plugged in or turned on to run the water feature.

My pump is making a loud noise. How do I fix that?

1. Be sure the pump is fully submerged in water. If it is not, and pulling in air, it will make unwanted noise.
2. Check to make sure the pump is not touching the water feature anywhere other than the bottom. If it is up against the side wall or another part, the vibration from the pump can cause unwanted noise. If moving the pump away from other parts does not work, try placing a sponge or other soft material between these areas to pad the pump.

51035BLSL ASSEMBLY INSTRUCTIONS

FREQUENTLY ASKED QUESTIONS CONTINUED

How do I change my pump speed? Depending on the type of pump, you will need to either move the slider or turn the knob.

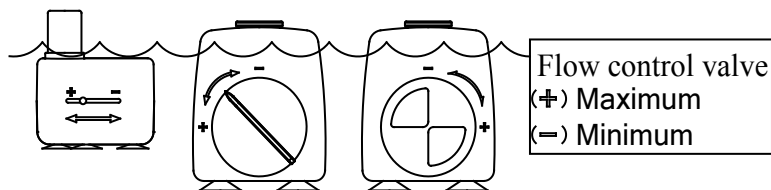

How do I clean my pump?

1. Disconnect the power supply and then remove pump cover/filter.
2. Gently pull impeller/rotor assembly out of the pump housing
3. Rinse the impeller/rotor assembly and the cavity with clean water.
4. If your pump comes with a sponge filter rinse this with clean water.
Algae buildup can be flushed out with a garden hose.

How do I level the water feature?

For the water to flow properly, it is critical the water feature is level. If your water feature will be placed in an area with uneven ground, use a level and leveling shims to help level the water feature. Shims are wedge-shaped plastic parts that can be placed between the water feature and the ground to create a level surface.

My tube is too long. What can be done to fix this?

The hose can be cut with a sharp blade or pair of scissors to the desired length.



KenroyHome

ALL • TOGETHER • BETTER



www.kenroyhome.com