

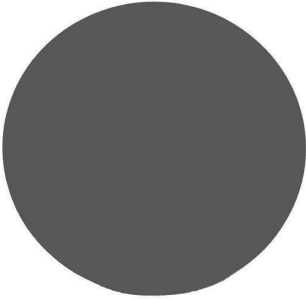







Square/Round Table Top • INSTRUCTIONS

(MKTBX22, MKTBX30, MKTBX36, TTSQ3030, TTSQ3636, TTSQ4242, TTSQ4848, TTRD30, TTRD36, TTRD42, TTRD48)

**Organize your parts. You will need a phillips head screw driver, crescent wrench, tape measure and pencil, drill(optional).
Two people are required for assembly.**

<p>A</p> 	<p>A2</p> 	<p>B</p> 	<p>C</p> 	<p>E</p> 	<p>F</p> 	<p>G</p> 	<p>A. Square Top A2. Round Top B. Large Base C. Cylinder D. Spider E. Rod F. Foot (4) G. Screws (8)</p>
---	--	--	---	---	---	---	--

Step 1: Screw 4 feet (F) into base (B) leg ends.



Step 2: Remove the nut from rod (E) and set aside.

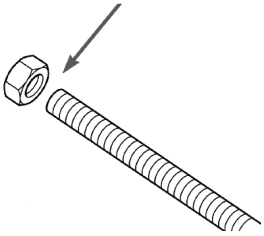



Step 3: Insert the rod (E) through the hole in the base (B) and attach nut to exposed rod end under base bottom.

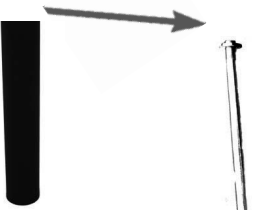

STEP 4: Next place the cylinder (C) over the exposed metal rod (E).

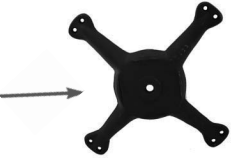

STEP 5: Place the exposed end of the metal rod (E) through the hole in the spider (D) and twist the second nut back onto the rod until tight



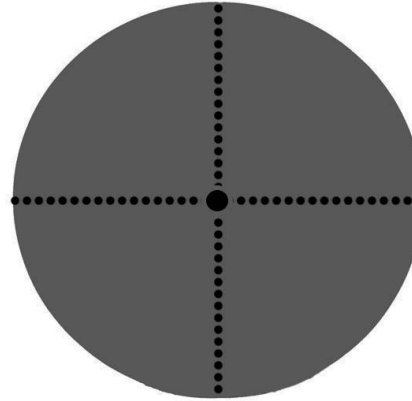
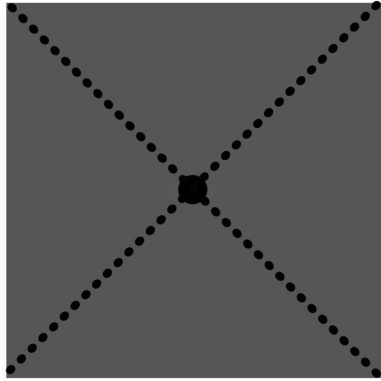

Step 6: Prepare your Template (INCLUDED) by adhering both template pages to one another on the dashed line.

STEP 7: Turn Table Upside down. According to your table top(Square or Round) draw 2 diagonal lines across the table as shown below.

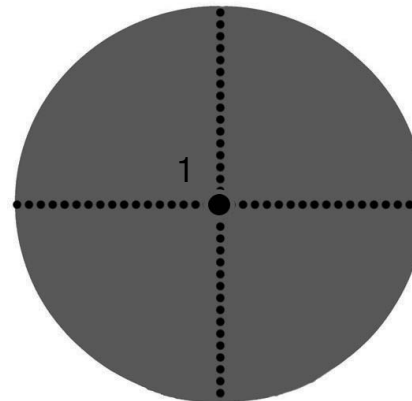
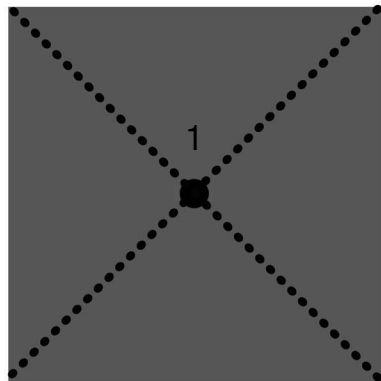

STEP 8: Place dot 1, located on the template, directly over the crossing lines.



STEP 9: Once aligned, mark template dots 2,3,4,5 on table bottom.

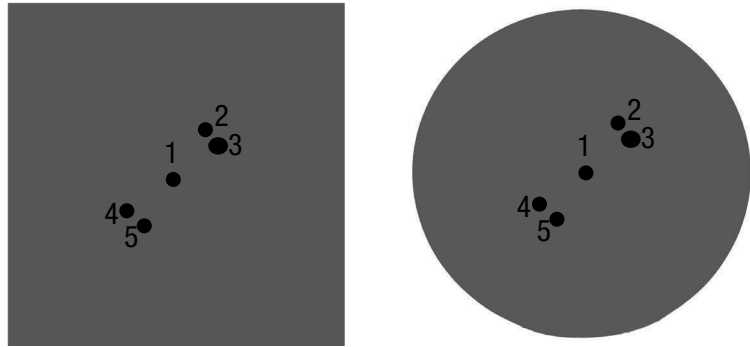

STEP 10: Place table top (A,A2) flat on the floor and set the completed base over the center.

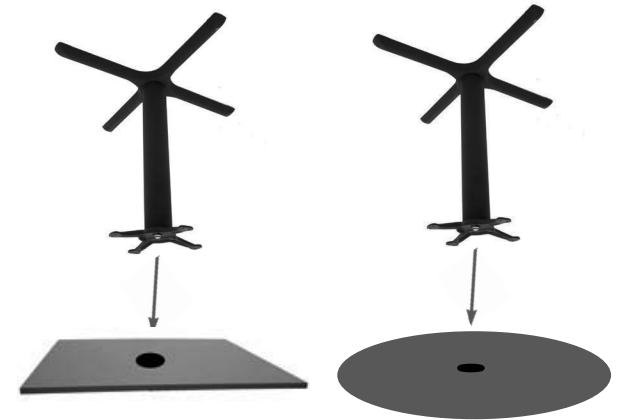

STEP 11: Line Up the marks made on table from step 9 with the holes on the spider arms. Attach using 8 Screws(G) and flip table over.

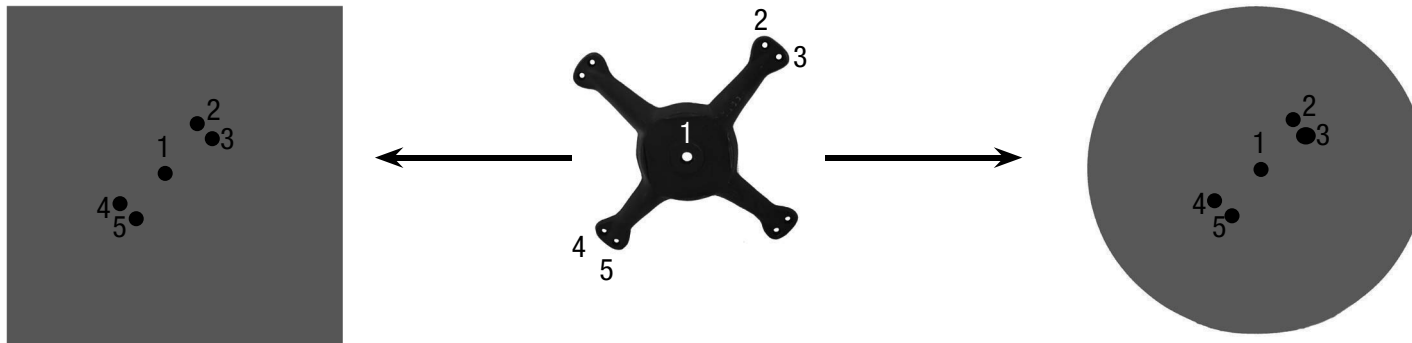

IMPORTANT NOTICE

Place all wooden parts on a clean and smooth surface such as a rug or carpet to avoid the parts from being scratched.

Check to be sure that you have all parts and hardware.

Remove all wrapping materials, including staples & packing straps before you start to assemble.

Do not tighten all screws/bolts until completely assembled.

Keep all hardware parts out of reach of children.

Any problems or questions please call Regency Office Furniture at 1-866-816-9822

-The Outside dots are for 48" Table tops and MKTBX 36 X-Bases.

-The Inside dots are for 30", 36" and 42" Table tops and MKTBX 22 & 30 X-Bases.

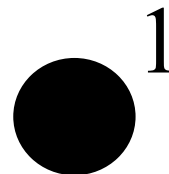
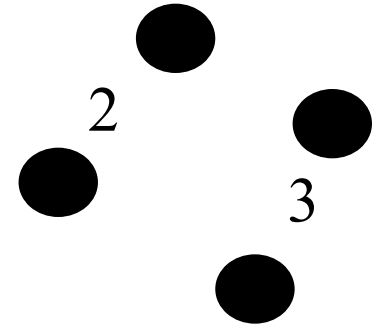

LINE UP TOP EDGE OF SECOND SHEET HERE.

