

FABRAL®

METAL WALL AND ROOF SYSTEMS



TOTAL SYSTEMS

PRODUCT SELECTION GUIDE

TOTAL SYSTEMS

PRODUCT SELECTION GUIDE



This product selection guide will lead you to the right solutions for your design challenges.

Fabral offers metal panels, system components, and accessories to meet all of your needs. Whether an agricultural, light commercial or residential project, exploring this guide will help find your answers.

AGRICULTURAL

Fabral metal roofing and siding systems will work for you by protecting your assets within barns and other agricultural buildings with little maintenance. Metal provides security when durability and longevity are essential.



LIGHT COMMERCIAL

For your light commercial needs, Fabral offers metal roofing and walls with easy installation and minimal maintenance. Design flexibility allows you to use these panels on various applications.



RESIDENTIAL

Homeowners can feel confident that Fabral metal roofing will provide the durability and energy efficiency they deserve. This investment provides a lifetime of satisfaction due to its low maintenance properties and curb appeal.

FABRALCORE™

A woman with blonde hair, wearing a bright red long-sleeved shirt and a silver headset, is shown from the side, looking at a large black computer monitor. The background is a plain, light-colored wall.

You challenge us. And we like it.

Your vision for a building and what you want to achieve makes us think harder. We like it when you bring us a problem because we know we'll find the solution. We have the products, the manufacturing and the know-how. We offer everything you need for the *total* building envelope solution. At our core, we relish a challenge.

To learn more contact us at 800.477.2741
or Fabral.com

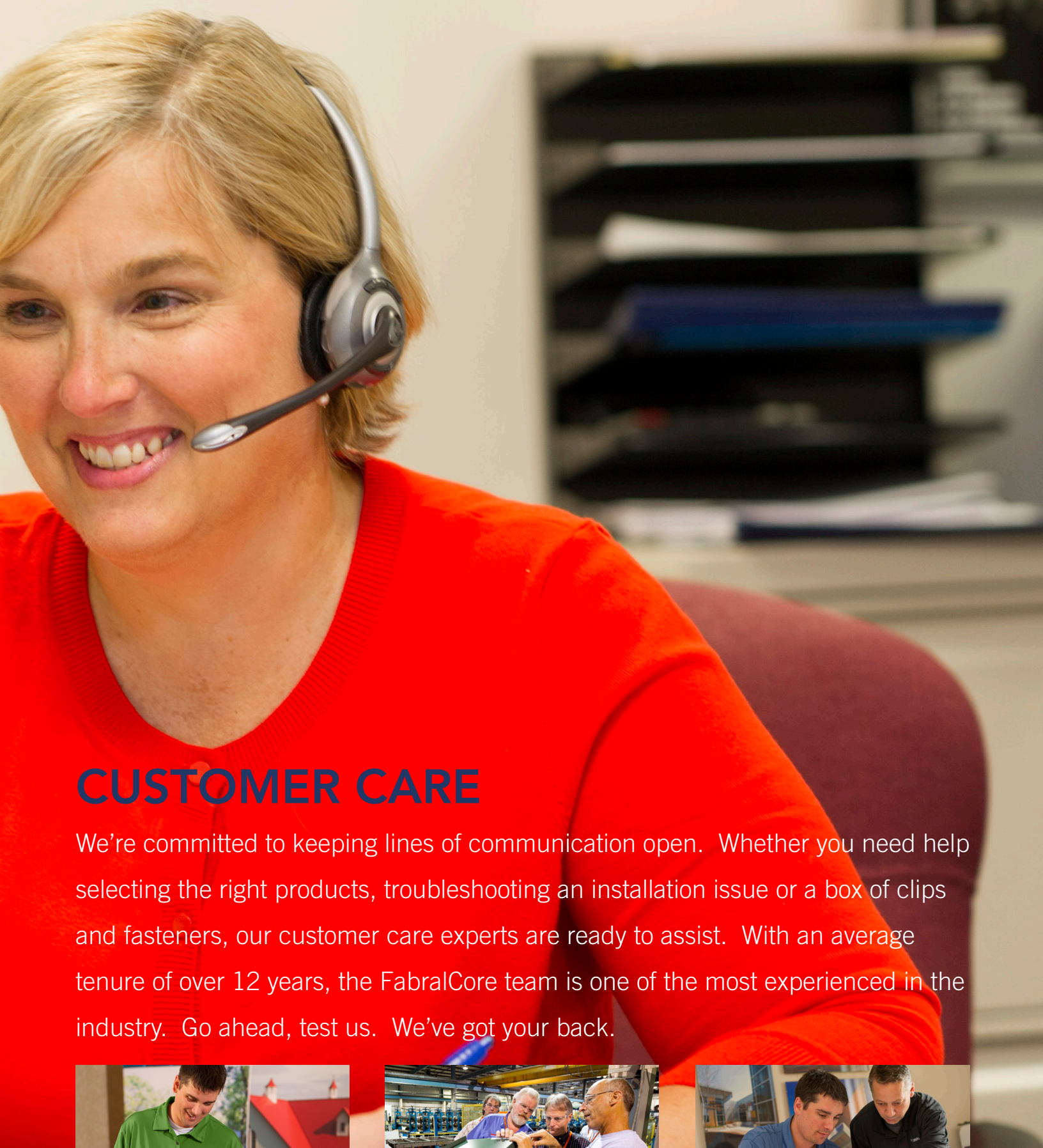

CUSTOMER CARE

We're committed to keeping lines of communication open. Whether you need help selecting the right products, troubleshooting an installation issue or a box of clips and fasteners, our customer care experts are ready to assist. With an average tenure of over 12 years, the FabralCore team is one of the most experienced in the industry. Go ahead, test us. We've got your back.



EDUCATION



PROJECT CONSULTING



TECHNICAL SUPPORT

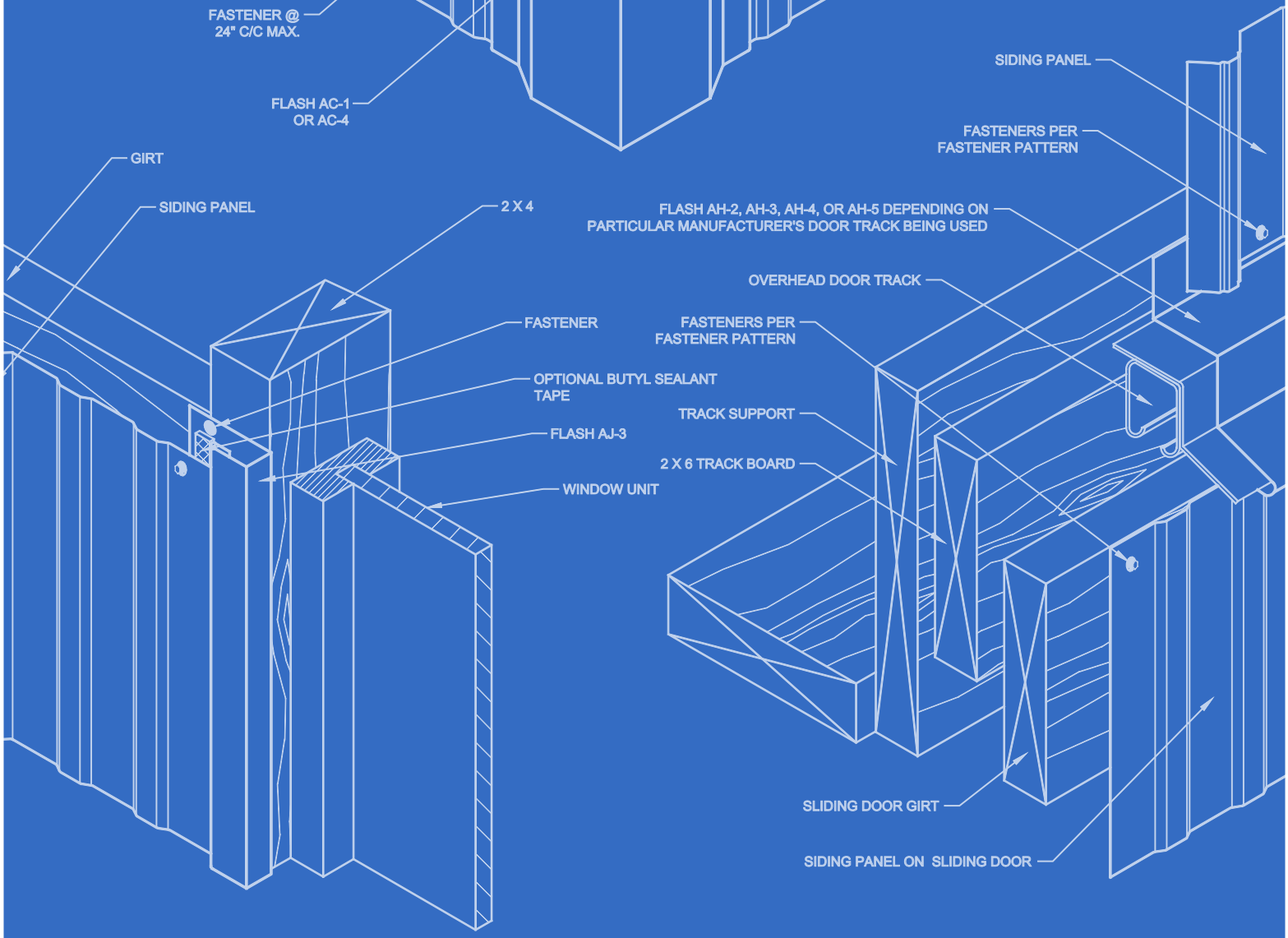
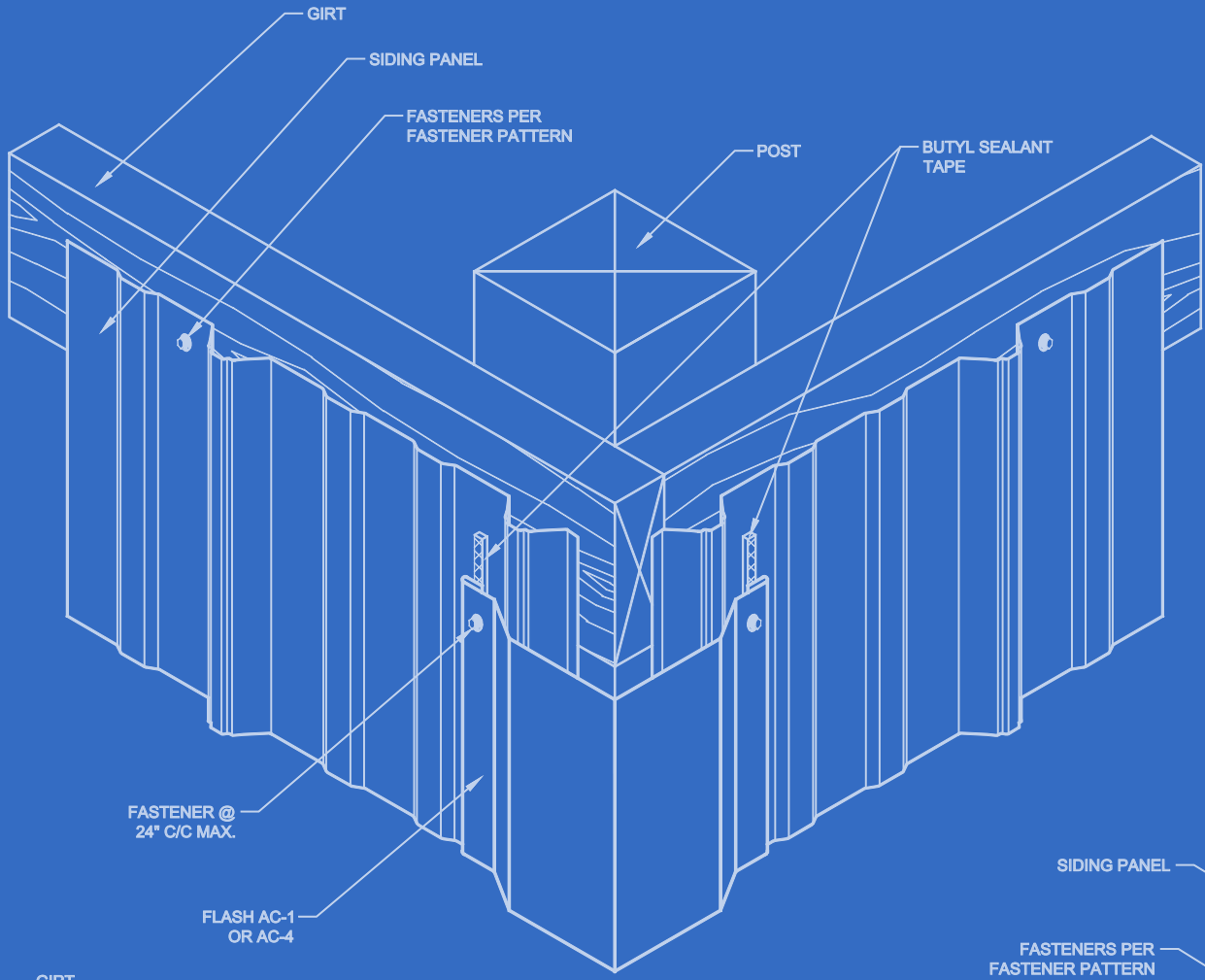

TABLE OF CONTENTS



This building features Grandrib 3 Plus siding in Tan with a Grandrib 3 Plus Cocoa Brown roof.



Grandrib 3 in Brick Red on the walls and Charcoal Gray on the roof create a classic American look on this barn.



1 ½" SSR in Acrylic Coated Galvalume, selected for its reflective qualities, covers the roof of this home.

Roof & Wall Systems

Exposed Fastener Panels

Grandrib 3 Plus	3
Grandrib 3	5
TrustiRib	7
Mighti-Rib	8
Prime Rib	9
ProClad	9
StrongClad	9
1 ¼" Corrugated	10
2 ½" Corrugated	10

Standing Seam Panels

1 ½" SSR	11
Horizon S	13

System Components

Flashing and Trim	17
Soffits	17
Underlayment	17
CondenStop®	17
Polycarbonate Panels	17
Liner Panels	17
Snow Retention	19

System Components Continued

Fasteners	19
Venting and Closures	19
Sealants	19

Colors & Finishes

Standard Stocked	21
------------------------	----

Accessories

Flat Sheets	25
Cupolas	25
Backer Rod	25
Retrofit Systems	25
Pipe Boots	25
Door and Door Tracks	26
Touch-up Paint	26
Chimney Pots	26
Custom Copper	26

Environmentally Conscious... 27

Warranty Information 28

ROOF & WALL

Fabral is dedicated to providing quality products for your building requirements. With our roof and wall systems, you will have access to everything needed for a successful installation.

Roof & Wall Systems

Exposed Fastener Panels

Grandrib 3 Plus

Grandrib 3

TrustiRib

Mighti-Rib

1 ¼" Corrugated

2 ½" Corrugated

Prime Rib

ProClad

StrongClad

Standing Seam Panels

1 ½" SSR

Horizon S



Metal roofs are both functional and aesthetically pleasing. Fabral metal roofing requires minimal maintenance and provides a safe and durable covering to buildings.



To learn more visit Fabral.com

SYSTEMS

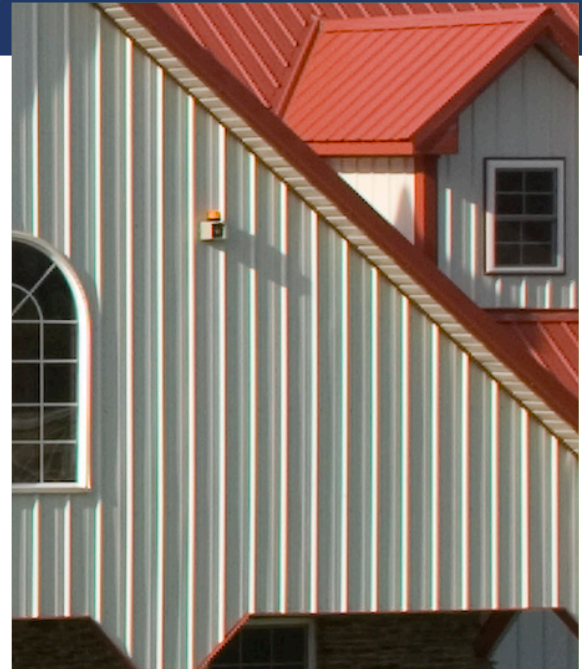

Fabral is a market leader in metal wall systems. Panels are available in a variety of colors to meet your design needs.

For more information, please reference our informative Blue Book guide: Standard Details for Metal Roofing & Siding. Fabral.com/tech-center

EXPOSED FASTENER PANELS

FABRAL® GRANDRIB 3 PLUS

This enhanced version of the original Grandrib 3 panel has a G-90 coating for better weather performance and durability. Grandrib 3 Plus is a thicker metal panel, increasing strength and appearance while still providing the traditional benefits of a metal roof. Complete with a wide range of color selections, this panel is a superior choice.



Project features Grandrib 3 Plus, aluminum soffit and cupolas.

PROJECT COMPONENT CHECKLIST

SYSTEM COMPONENTS

- Underlayment
- Fasteners
- Flashing and Trim
- Venting and Closures
- Soffits
- Snow Retention

ACCESSORIES

- Cupolas
- Door and Door Tracks
- Pipe Boots
- Custom Copper Cupolas, Dormers, Spires and Finials

Grandrib 3 Plus is used for the roof and walls of this barn.



PANEL SPECS

- Minimum pitch recommended 2½:12
- 36" coverage with ¾" rib height
- UL 790 Class A Fire Resistance Rating
- UL 2218 Class 4 Hail Impact Resistance
- UL 580 Class 90 Uplift Test Rating
- High performance Enduracote paint system features an Energy Star® approved standard color offering, 10 Layers
- Custom cut to lengths up to 40'
- Anti-Siphon sidelap design
- Excellent wind uplift and snow load ratings

SUBSTRATES

- 29 gauge structural quality full-hard steel
- G90 galvanized

SYSTEM COMPONENTS

FLASHING AND TRIM	17
SOFFIT	17
UNDERLAYMENT	17
VENTING AND CLOSURES.....	19
SEALANT.....	19
FASTENERS.....	19
COLOR OFFERING	21
WARRANTY INFORMATION	28

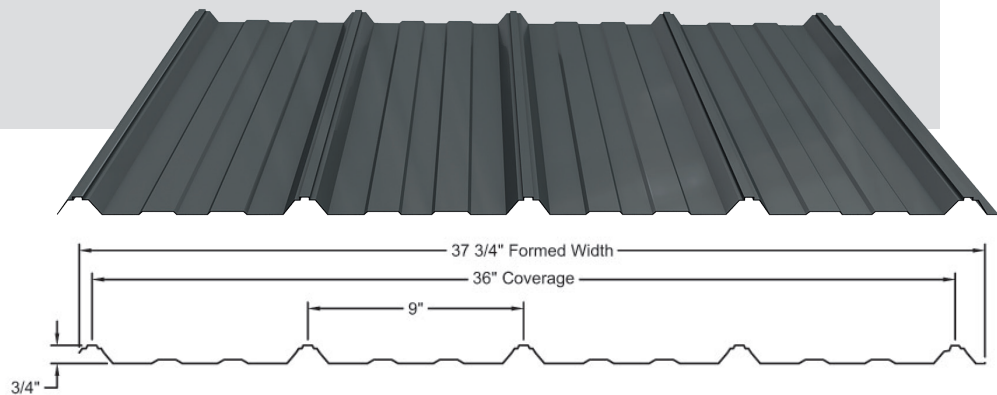

EXPOSED FASTENER PANELS

FABRAL® GRANDRIB 3

Grandrib 3 is the “benchmark of the industry” and can be used for walls and roofs. This unique and versatile panel is available in a variety of popular colors. The panels have clean traditional lines, and are manufactured from the best structural steel available.



Grandrib 3 in Antique Bronze and Hickory Moss shown with a cupola.

PROJECT COMPONENT CHECKLIST

SYSTEM COMPONENTS

- Underlayment
- Fasteners
- Flashing and Trim
- Venting and Closures
- Soffits
- Snow Retention

ACCESSORIES

- Cupolas
- Door and Door Tracks
- Pipe Boots

Grandrib 3 with Evergreen roof complete with gutter system.



PANEL SPECS

- Minimum pitch recommended 2½:12
- 36" coverage with ¾" rib height
- UL 790 Class A Fire Resistance Rating
- UL 2218 Class 4 Hail Impact Resistance
- UL 580 Class 90 Uplift Test Rating
- High performance Enduracote paint system features an Energy Star® approved standard color offering, 10 layers
- Custom cut to lengths up to 40'
- Anti-siphon sidelap design
- Excellent wind uplift and snow load ratings

SUBSTRATES

- 29 gauge structural quality full-hard steel
- G60 galvanized or AZ50 galvalume*
- 26 gauge high strength galvalume steel
- .016" aluminum

*Differs by market

SYSTEM COMPONENTS

FLASHING AND TRIM	17
SOFFIT	17
UNDERLAYMENT	17
VENTING AND CLOSURES	19
SEALANT	19
FASTENERS	19
COLOR OFFERING	21
WARRANTY INFORMATION	28

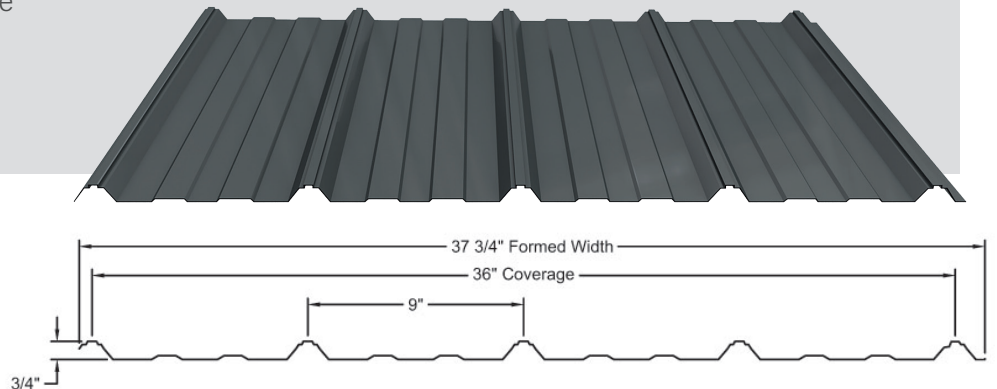

EXPOSED FASTENER PANELS

FABRAL® TRUSTIRIB™

These panels are made of utility grade construction with zinc aluminum protective coating. The vertical lines and thirteen popular colors make this an economical and durable solution for a variety of structures.



This two car garage features TrustiRib in Ivory.

PANEL SPECS

- Minimum pitch recommended 2½:12
- 36" coverage with ¾" rib height
- UL 790 Class A Fire Resistance Rating
- UL 2218 Class 4 Hail Impact Resistance
- SMP paint system, 5 layers of topcoat protection
- Custom cut to lengths up to 40'

SYSTEM COMPONENTS

FLASHING AND TRIM	17
SOFFIT.....	17
UNDERLAYMENT.....	17
VENTING AND CLOSURES.....	19
SEALANT.....	19
FASTENERS.....	19
COLOR OFFERING	21
WARRANTY INFORMATION	28

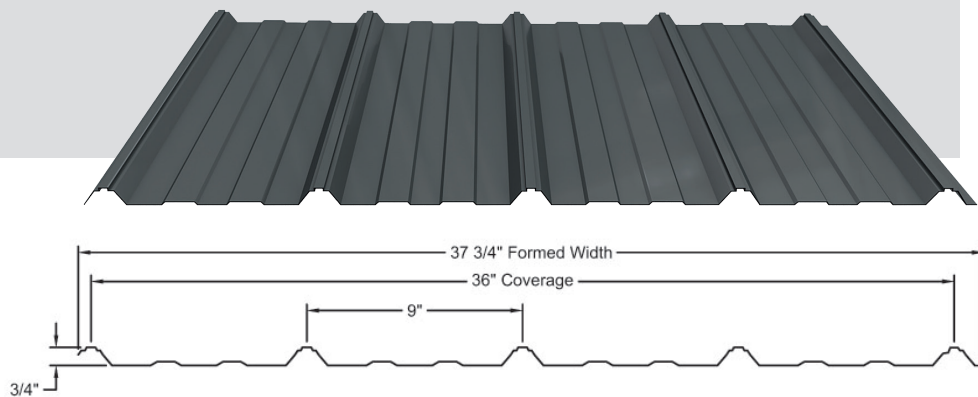

FABRAL® MIGHTI-RIB

For commercial and industrial projects, this deep rib panel is a great fit. The 26 gauge steel of Mighti-Rib creates a strong panel that is enhanced by a purlin bearing leg. It is available either unpainted or finished with a high-performance Enduracote paint system.



A storage unit using Mighti-Rib for its walls.

PANEL SPECS

- Minimum pitch recommended 1:12
- 36" coverage with 1 1/4" rib height
- UL 790 Class A Fire Resistance Rating
- UL 2218 Class 4 Hail Impact Resistance
- UL 580 Class 90 Uplift Test Rating
- High performance Enduracote paint system features an Energy Star® approved standard color offering
- Custom cut to lengths up to 40'
- Also known as PBR

SUBSTRATES

- 26 gauge high strength steel
- AZ50 painted, AZ55 plain

SYSTEM COMPONENTS

FLASHING AND TRIM	17
SOFFIT	17
UNDERLAYMENT	17
VENTING AND CLOSURES.....	19
SEALANT.....	19
FASTENERS.....	19
COLOR OFFERING	21
WARRANTY INFORMATION	28

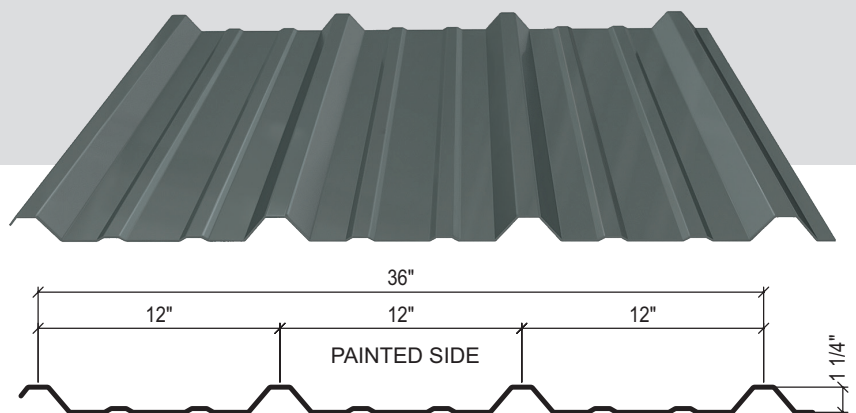

EXPOSED FASTENER PANELS

FABRAL® PRIME RIB

PANEL SPECS

- Minimum pitch recommended 2½:12
- 36" coverage with ½" rib height
- UL 790 Class A Fire Resistance Rating
- UL 2218 Class 4 Hail Impact Resistance
- High performance Enduracote paint system features an Energy Star® approved standard color offering
- Custom cut to lengths up to 40'

SUBSTRATES

- 29 gauge full hard steel
- G60 galvanized

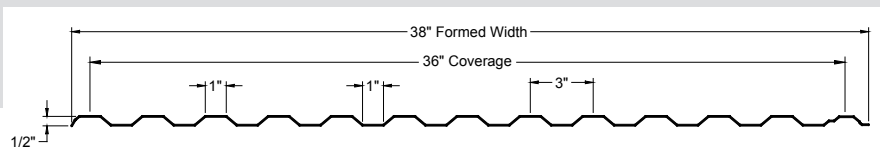
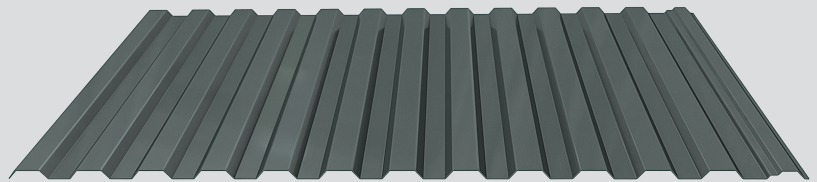

FABRAL® PROCLAD

PANEL SPECS

- Minimum pitch recommended 2½:12
- 36" coverage with 5/8" rib height
- UL 790 Class A Fire Resistance Rating
- UL 2218 Class 4 Hail Impact Resistance
- High performance Enduracote paint system features an Energy Star® approved standard color offering
- Custom cut to lengths up to 40'

SUBSTRATES

- 29 gauge full hard steel
- G60 galvanized

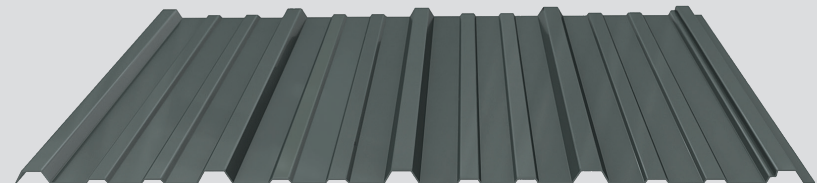

FABRAL® STRONGCLAD

PANEL SPECS

- Minimum pitch recommended 2½:12
- 36" coverage with 5/8" rib height
- UL 790 Class A Fire Resistance Rating
- UL 2218 Class 4 Hail Impact Resistance
- High performance Enduracote paint system features an Energy Star® approved standard color offering
- Custom cut to lengths up to 40'

SUBSTRATES

- 29 gauge full hard steel
- G60 galvanized

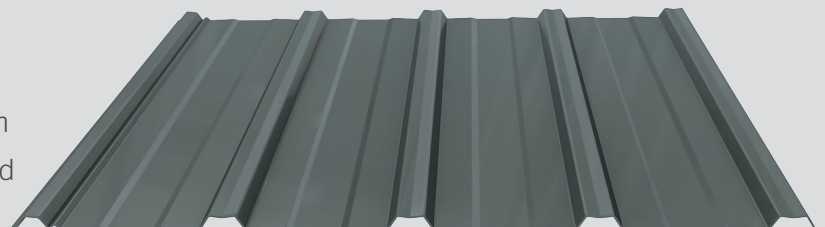

FABRAL® 1 1/4" CORRUGATED

PANEL SPECS

- Minimum pitch recommended 2½:12
- 24" coverage with ¼" rib height

SUBSTRATES

- 29 gauge plain steel

SYSTEM COMPONENTS

FLASHING AND TRIM	17
VENTING AND CLOSURES.....	19
SEALANT.....	19
FASTENERS.....	19

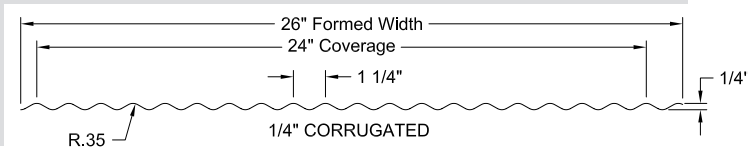
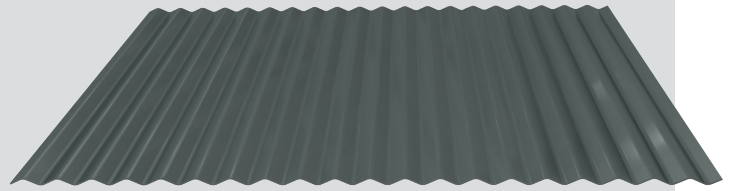

FABRAL® 2 1/2" CORRUGATED

PANEL SPECS

- Minimum pitch recommended 2½:12
- 24" coverage with ½" rib height
- UL 790 Class A Fire Resistance Rating
- UL 2218 Class 4 Hail Impact Resistance
- Available plain or finished (26 ga only) with the high performance Enduracote paint system featuring an Energy Star® approved standard color offering
- Color offering varies by panel width and gauge

SUBSTRATES

- 29 gauge steel
- 26 gauge steel painted only
- Economy grade

SYSTEM COMPONENTS

FLASHING AND TRIM	17
VENTING AND CLOSURES.....	19
SEALANT.....	19
FASTENERS.....	19

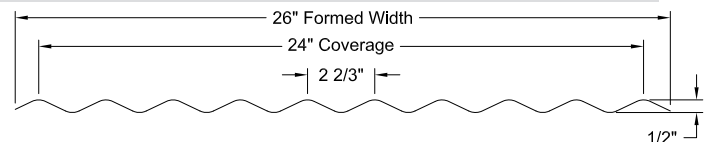
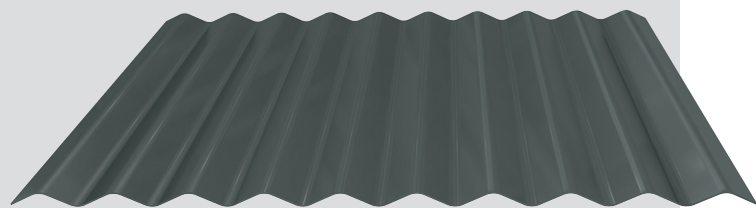

STANDING SEAM PANELS

FABRAL® 1 1/2" SSR

This classic style metal roof delivers value, beauty, and performance. Featuring 24 gauge steel, standard shadow lines and standard factory applied sealant, the 1 1/2" SSR panel is ideal for residential, commercial or re-roofing applications and designed to perform at optimum levels year after year.



This home features a standing seam roof with Chimney Pot accents and a Snow Retention System.

PROJECT COMPONENT CHECKLIST

SYSTEM COMPONENTS

- Underlayment
- Clips
- Sealant
- Venting and Closures
- Soffits
- Snow Retention

ACCESSORIES

- Cupolas
- Door and Door Tracks
- Retrofit System
- Chimney Pots

1 1/2" SSR in Antique Bronze shown here equipped with a Snow Retention System.



PANEL SPECS

- Minimum pitch recommended 1:12
- 16" coverage with 1 1/2" seam height
- UL 790 Class A Fire Resistance Rating
- UL 2218 Class 4 Hail Impact Resistance
- UL 580 Class 90 Uplift Test Rating
- High performance Enduracote paint system features an Energy Star® approved standard color offering
- Concealed clip fastening system allows for thermal movement
- Factory applied sealant
- Shadow lines standard to enhance appearance (can be ordered without shadow lines, specify at time of order)
- Custom cut to lengths up to 40'

SUBSTRATES

- 24 gauge high strength steel

SYSTEM COMPONENTS

FLASHING AND TRIM	17
SOFFIT	17
UNDERLAYMENT	17
VENTING AND CLOSURES.....	19
SEALANT.....	19
FASTENERS.....	19
COLOR OFFERING	21
WARRANTY INFORMATION	28

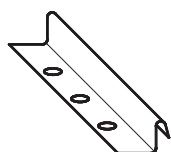

Concealed clip fastening system allows for thermal movement.

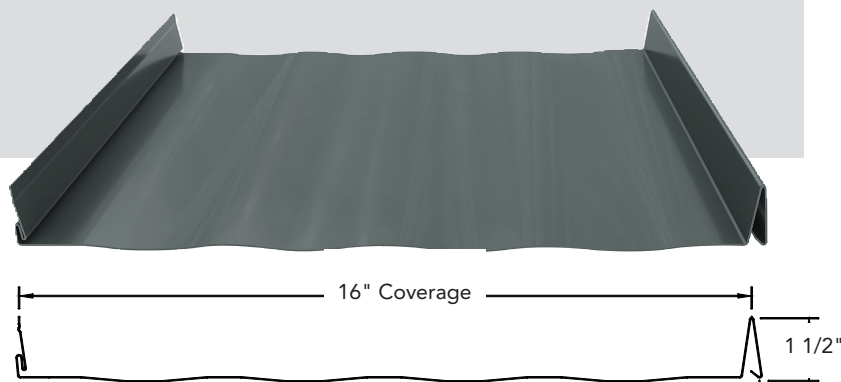

Factory Applied Sealant
Available with Shadow Lines or Flat Pan

STANDING SEAM PANELS

FABRAL® HORIZON S

Horizon S offers a roofing choice for residential and light commercial applications. This standing seam panel with a snap-lock design features pre-punched fastener slots. Standard shadow lines enhance the appearance of this 26 gauge panel.



Horizon S in Charcoal Gray covers the roof of this home.

PROJECT COMPONENT CHECKLIST

SYSTEM COMPONENTS

- Underlayment
- Flashing and Trim
- Fasteners
- Sealant
- Venting and Closures
- Soffits
- Snow Retention

ACCESSORIES

- Door and Door Tracks
- Retrofit System

Roof featuring Horizon S Antique Bronze with Snow Retention System.



PANEL SPECS

- Minimum pitch required 3:12
- 16" coverage with 1" seam height
- UL 790 Class A Fire Resistance Rating
- UL 2218 Class 4 Hail Impact Resistance
- UL 580 Class 90 Uplift Test Rating
- High performance Enduracote paint system features an Energy Star® approved standard color offering
- Factory applied sealant
- Custom cut to lengths up to 40'
- Shadow lines standard to enhance appearance
- Similar to Climaguard and Horizon 16

SUBSTRATES

- 26 gauge high strength steel

SYSTEM COMPONENTS

FLASHING AND TRIM	17
SOFFIT.....	17
UNDERLAYMENT.....	17
VENTING AND CLOSURES.....	19
SEALANT.....	19
FASTENERS.....	19
COLOR OFFERING	21
WARRANTY INFORMATION	28

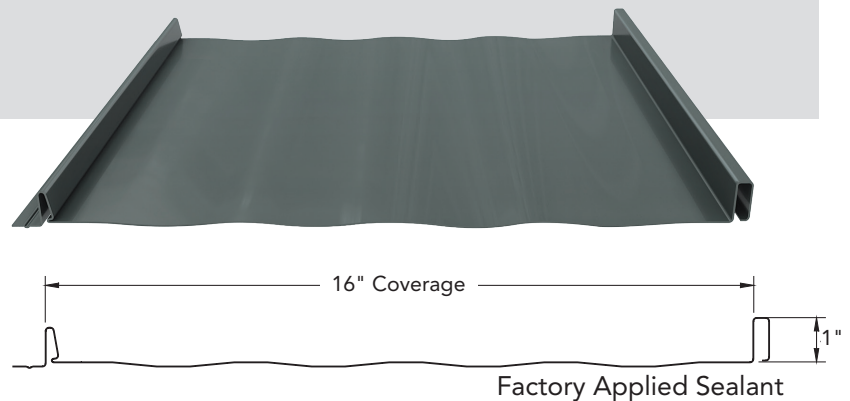

SYSTEM COMP

The best metal clad buildings use integrated system components. Fabral always thinks about the whole project by engineering solutions that consider all of the materials needed.

System Components

Flashing and Trim

Soffits

Underlayment

CondenStop

Polycarbonate Panels

Liner Panels

Snow Retention

Gutters

Fasteners

Venting and Closures

Sealants



To learn more visit Fabral.com

COMPONENTS



Fabral components are engineered for efficient installation and designed for various applications. Your FabralCORE Customer Care representative will help select the right components for your project.



For more information, please reference our informative Blue Book guide: Standard Details for Metal Roofing & Siding. Fabral.com/tech-center

FLASHING AND TRIM



SOFFITS

Soffit panels keep buildings ventilated allowing them to “breathe” and helping to prevent damaging moisture from being trapped in attics and eaves. Various ventilation patterns can be accomplished by alternating solid and vented or perforated panels.



CENTER VENT

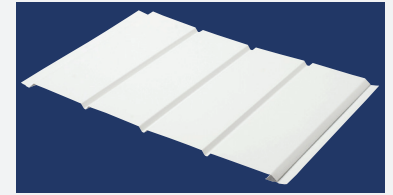

SOLID SOFFIT

UNDERLAYMENT

Fabral provides the necessary secondary weatherproofing membrane components with its self-adhering underlayment product (30 year peel & stick) offering easy installation and peace-of-mind for a dry, sound installation. Our synthetic, mechanically fastened systems offer superior protection to old, felt underlayment.

30 YEAR PEEL & STICK

- Watertight Self-Sealing Underlayment
- Asphalt-to-Asphalt Lap System
- Roll Size: 3' W x 72' L
- Square Feet Per Roll: 200

CONDENSTOP™

Stop condensation with Fabral factory applied CondenStop™. CondenStop saves time and money by reducing labor costs and installation time versus other condensation barriers. Easily and effectively prevent condensation and the problems caused by condensation by installing Fabral panels featuring CondenStop.

POLYCARBONATE PANELS

Translucent panels transmit natural light affording for better work conditions and potentially reducing energy costs. These wall siding panels are ideal for use in agricultural, light commercial, warehouse, and industrial facilities. Available in lengths: 8', 10' and 12'

LINER PANELS

Fabral liner panels are perfect for interior projects requiring additional insulation, strength or acoustical control. Additionally these panels are an economical light gauge panel solution for projects requiring partitions.

Fabral offers a standard package of flashing and trim for a variety of applications. Flashing is factory-formed at 10' 6" lengths and available in steel and aluminum with coordinating Enduracote finishes and colors. Flat metal sheets are also available when installer fabrication is preferred.



Flashing details and assistance with flashing details are available from your FabralCORE Customer Care representative. Standard details are illustrated in the Fabral Blue Book.

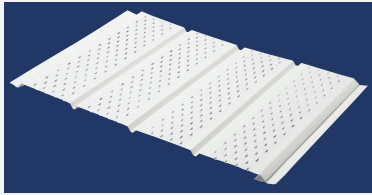

FULL VENT

Fabral Soffits are available in three pre-formed engineered profiles - two ventilated (center and full) for increased air flow and one solid.

SOFFIT DETAILS

- Full, Center, and Non-Vented Soffit Panels
- Aluminum – recyclable and sustainable
- Pre-cut 16" coverage
- Quad 4 vented – 12.96 sq.in./lineal ft free airspace
- Available in standard and custom lengths

30 YEAR SYNTHETIC

- Installation Requires mechanical fasteners
- Roll Size: 4' W x 250' L
- Square Ft Per Roll: 1,000



50 YEAR SYNTHETIC

- Installation Requires mechanical fasteners
- Roll Size: 4' W x 250' L
- Square Ft Per Roll: 1,000

- Protects assets and investments from moisture
- Can be used in place of traditional vapor retarders
- Adds to interior corrosion protection
- Light gray color enhances the indoor look of an open framing structure roof
- Available for the Grandrib 3 painted panel offerings

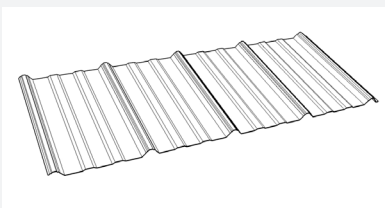
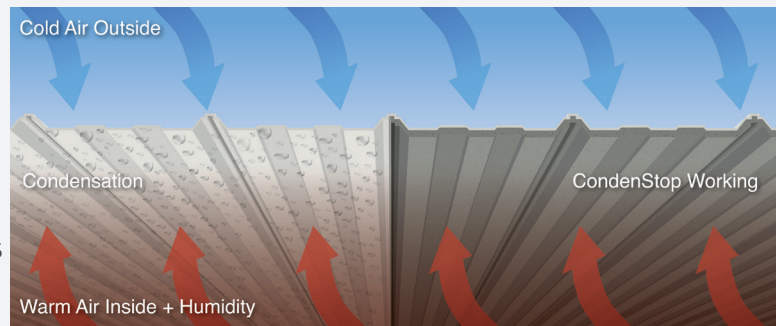

POLYCARBONATE

- Virtually unbreakable
 - Will not yellow
 - Easily and safely installed on sidewalls
 - Colors: Clear and White
- (Grandrib 3, Mighti-Rib, Ridge Caps)

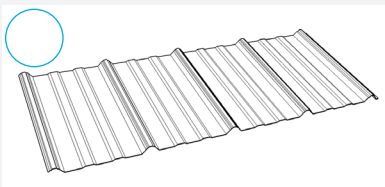

- Custom cut lengths up to 40'
- Easy to clean
- Polyester paint finish
- Acoustical panels perforated across entire panel
- 36" coverage

SNOW RETENTION SYSTEMS

Snow retention systems are a smart decision. Because metal roofs are naturally slippery, snow and ice move quickly over the smooth surface, possibly damaging plumbing stacks and lower roof planes, as well as possibly endangering people and property. Any project in a freeze/thaw zone should employ a snow retention system.

EXPOSED FASTENER

RTCLSR RTCLSM



RT MINI



CL SNOW GUARD

- Premium polycarbonate plastic with UV stabilizers
- Unique vent rib systems allows for adhesive out gassing
- Three-to-one base-to-blade ratio adds significantly to strength

MINI CLEAR SNOW GUARD

- Premium polycarbonate plastic with UV stabilizers
- Maximum protection, moderately priced
- Two-to-one base-to-blade ratio
- 4.5 sq.in. and gusseted blade snow pocket
- Typically installed by adhering to and mechanically fastened to the roofing panel

#640- Low profile option (not shown)

#20- Designed to fit 1/2" Corrugated panels (not shown)

FASTENERS

Understanding and installing which fasteners are best for which application is critical to any project. Be sure to match the correct screw or fastener option with the appropriate roof or wall system. For more information check with your FabralCore representative.

- * Painted
- ** Plain
- *** Plain and Painted



#10 WOODTite High Low***

- Use with dimensional lumber
- Available in 1", 1½", 2", 2½" and 3"
- 1/4" hex head, EPDM/metal washer
- Oxyseal Long-Life Coating

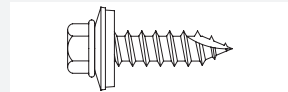

#14-10 WOODTITE***

- Use to fasten metal to plywood or OSB
- Use for trim attachment
- Available in 1", 1½", and 2"
- 5/16" hex head, EPDM/metal washer
- Oxyseal Long-Life Coating

VENTING AND CLOSURES

Roof ventilation and uniform airflow are key to keeping metal clad buildings “healthy.” Correctly engineered vent and closure systems “manage” weather limiting wind-driven rain from entering the ridge area and facilitating “moisture release.”

CLOSURE SPECS

- Available in Grandrib 3, Strongrib, 1¼" Corrugated, 2½" Corrugated, ProClad and 5V profiles

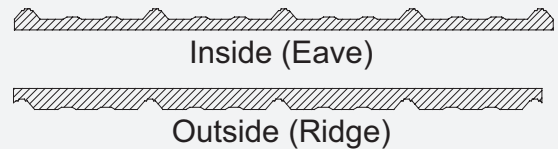

SEALANTS

Fabral sealants provide a weather-tight seal against water, wind, dust, and dirt. Excellent for use on a variety of metal roof, trim siding, gutters, flashing and downspouts, sealants are available in over 50 colors (some special order) to coordinate with the full range of Fabral metal finishes.

STANDING SEAM

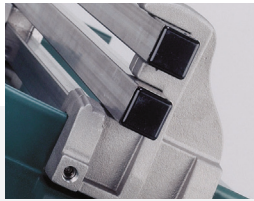

F-RAIL

- Accommodates up to 4 rails of protection
- Customized rail tubing
- Functions below the standing seams
- Easy to retrofit to existing roofs

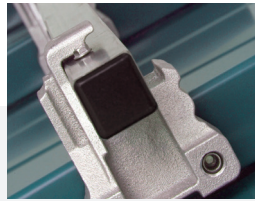

E-RAIL

- Dual rail, low profile snow retention systems
- Stronger, lighter system
- Receptor slot for custom ornamental attachment

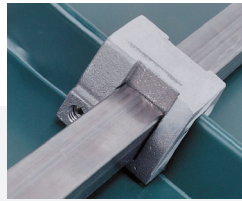

S-RAIL

- Single rail, low-profile snow retention systems
- Functions below the standing seams
- Economical snow rail
- Easy to retrofit to existing roofs

SL1



SL1 SNOW MEISTER SNOW GUARD

- Available in mill finished aluminum, mill finished bronze, black e-coat primer or custom colors
- Two sizes to accommodate differing seam widths
- Use on Fabral 1½" SSR and Horizon S panels

AP

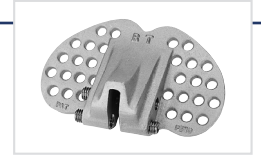

AP SNOW GUARD

- Available in mill finished aluminum and black e-coat primer
- Three sizes available to accommodate differing seam widths
- Use on Fabral 1½" SSR panel

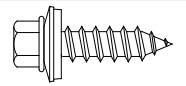

#12x3/4" STITCH*

- Use for trim attachment for Horizon S
- 1/4" hex head, EPDM/metal washer



#10-16 ULTIMATE WOODTITE**

- Use with ALL panels
- Available in 1", 1½", 2", 2 ½" and 3"
- 5/16" case zinc hex head
- Hex head & washer all one piece



#10-12 WAFER HEAD**

- Use with Horizon S panel
- Check with engineering department for spacing with OSB or ½" plywood
- Available in 1", 1½", 2" and self drillers
- Available with square drive head



#10-14 410 STAINLESS STEEL***

- Use with 26 gauge or thinner to avoid pre-drilling
- Available in 1", 1½", and 2"
- 1/4" hex head, EPDM/metal washer
- Use with steel panels installed on treated lumber
- Use with aluminum



#9-16 300 SERIES STAINLESS STEEL***

- Use for high corrosive environments
- Use with ALUMINUM panels
- Available in 1", 1½", and 2"
- 1/4" hex head, EPDM/metal washer
- Use with treated lumber



#10-1 PANCAKE HEAD**

- Use with 1½" SSR and concealed fastener panels
- Check with engineering department for spacing with OSB or ½" plywood

RIDGE CAP VENT

- Factory applied to the ridge cap
- Save up to half of your installation time
- Non-profile specific material
- Clean, dust free installation
- Virtually NO WASTED material
- 1½" x 3" material provides 17 sq. inches/lineal foot free area at the ridge

LP2 RIDGE VENT

- Available in Horizon S, Grandrib 3 and Mighti-Rib profiles
- Lower, custom-fit profile
- Moisture and pest barrier
- Non-obtrusive appearance
- Reduces utility costs
- One-person installation

RV35 AND RV100

- 10' metal ridge vent
- Variety of colors available

PROFILE FIT VENT-ROLL

- Available in Grandrib 3, 5V and SSR
- 10.66 sq. in. per lineal ft. of ridge (5.33 / side)

SEALANT

- Waterproof sealant to fill gaps up to 1"
- UV-resistant
- Permanent flexibility - won't crack
- Standard color: Gray (stocked)
- Up to 50 additional color options (non stocked)

SEALANT TAPE

- 3/16" x ½" x 40' (sidelap)
- 3/32" x ½" x 50' (endlap)
- 1/8" x 2" x 30'

SEALANT STRIP

- Use at valleys and hips
- 1" x 1" x 19' 6.8" long

COLORS & FINISHES



BRITE WHITE 824 IR=.67

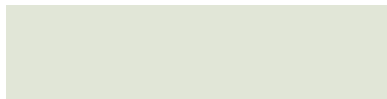

WHITE 899 IR=.60

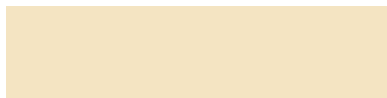

IVORY 883 IR=.66



LIGHT STONE 887 IR=.58



TAN 855 IR=.48



COCOA BROWN 856 IR=.34



DARK BROWN 859 IR=.30



ANTIQUe BRONZE 854 IR=.34



CARIBBEAN BLUE 881 IR=.33



GALLERY BLUE 826 IR=.28



BRICK RED 898 IR=.39



BRITE RED 845 IR=.43



CLASSIC BURGUNDY 853 IR=.32



HICKORY MOSS 870 IR=.41



PATINA GREEN 893 IR=.41



EVERGREEN 875 IR=.32



LIGHT GRAY 889 IR=.36



CHARCOAL GRAY 851 IR=.34

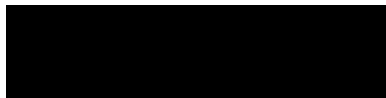

TRUE BLACK 882 IR=.31



HARTFORD GREEN 821 IR=.30

Availability	
Northeast / Mid-Atlantic	
Southern	
Midwest	
Western	
Color	
Brite White	824 / 724*
White	899 / 799*
Ivory	883 / 783*
Light Stone	887 / 787*
Tan	855 / 755*
Cocoa Brown	856 / 756*
Dark Brown	859
Antique Bronze	854 / 754
Caribbean Blue	881
Gallery Blue	826
Brick Red	898 / 798*
Brite Red	845
Classic Burgundy	853 / 753*
Hickory Moss	870 / 770*
Patina Green	893
Evergreen	875 / 775*
Hartford Green	821
Light Gray	889 / 789*
Charcoal Gray	851 / 751*
True Black	882
Bright Copper Penny	939
Sierra Brown	896
Ash Gray	848



valspar

All Fabral Enduracote (800 Series) colors are Energy Star® approved.

Colors are as actual as allowed by the printing process. Actual metal samples are available; request samples prior to installation. Note: colors vary depending on position and angles.

ACCESSORIES

A number of accessories are available as part of the Fabral offering. These items, range from pipe boots to door track systems, giving you the flexibility you need to customize your project.

Accessories

Flat Sheets

Cupolas

Backer Rod

Retrofit System

Pipe Boots

Doors

Door Track

Touch-up Paint

Chimney Pots

Custom Copper



Cupolas are an accessory which offer architectural detail to any building. Cupolas, finials and other architectural components can be customized to fit your project needs.





Doors and door track systems are integral accessories. Whether traditional entry or over-sized barn doors, Fabral offers engineered systems for an excellent fit.

For more information, please reference our informative Blue Book guide:
Standard Details for Metal Roofing & Siding. Fabral.com/tech-center

FLAT SHEETS

Fabral Flat Metal Sheets may be ordered for on-the-job fabrication. A wide variety of substrates are available including aluminum, galvanized steel, Galvalume, copper and stainless steel. Flat sheets may be coated with our premium Enduracote paint system offered in a full range of colors.

CUPOLAS

Cupolas are an excellent way to bring architectural detail to any structure. Fabral cupolas are built to order and are offered in a variety of sizes (up to 66" x 66"), shapes and colors. Flashings can be built to any roof pitch and optional windows may be built into the side panels. Base sizes include 24" x 24", 36" x 36", and 48" x 48".

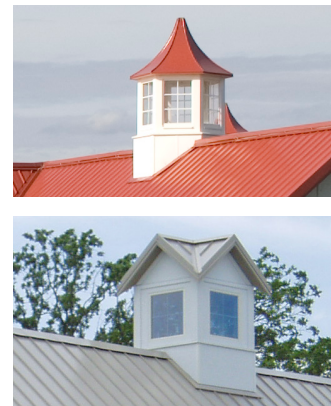

BACKER ROD

Used to fill joints between building materials, Fabral Closed-Cell Backer Rod repels moisture, provides a firm finish to the gap and is easily set into place with spray adhesive. Closed-Cell Backer Rod is suited for use as a backing material for standing seam applications. The round, flexible, continuous lengths of extruded, polyethylene foam is useful in minimizing "oil canning" with the 1 1/2" SSR panel.

RETROFIT SYSTEMS

Fabral metal-over-metal retrofit roof applications offer a structurally sound, non-disruptive and cost effective system for repair and renovating roofs. The system eliminates the need to remove previous roofing, saving up to 70% of labor. It requires only standard tools and fasteners and has pre-punched pilot holes for rapid fastening. Available in 10' lengths, 16 gauge – 50 KSI steel, the system is laboratory and load tested.

PIPE BOOTS

Sealing small pipes is made easier with pipe boots from Fabral. The metal base with a dome-shaped boot serves as a covering for vent pipes. Specifications include EPDM: up to 250° F; Silicon: up to 450° F

Base Diameter	Item No.	Pipe Size	
		min	max
7 3/4"	3	1/4"	5"
10 1/2"	5	4 1/4"	7 1/2"
16 1/2"	8	7"	13"

DOOR AND DOOR TRACKS

Fabral Door Systems include four door types and the complete corresponding track systems. For information on product availability, contact your FabralCore representative.

3100 SERIES DOOR

- Pre-hung 4-way universal swing
- 1-3/4" galvanized steel door
- Pressure injected with polyurethane foam
- Pre-painted with two coats of polyester paint

5100 SERIES DOOR

- Light commercial post frame entry door
- Rolled edge door panel
- 24-gauge polyester painted galvanized steel
- Heavy internal aluminum stiles and rails
- Heavy-duty 16-gauge 3-1/2" wide painted steel jambs
- 12-gauge stainless steel 4-1/2" x 4" fixed pin hinges

PARTNER DOOR

- Pre-finished/pre-hung 6-bend steel or extruded aluminum
- Pre-hung 4-way universal swing
- 29-gauge steel exterior

RESPONDER DOOR

- Pre-finished/pre-hung 6-bend steel or extruded aluminum
- Pre-hung 2-way universal swing
- 29-gauge steel exterior

DOOR TRACK SYSTEM

- Doors tracks, frames, bottom guide systems
- Trolleys, brackets, latches
- Rollers
- Sliding door accessories

TOUCH-UP PAINT

Fabral offers touch up paints in a full range of Enduracote colors. Contact your FabralCore representative to order the color you require.

CHIMNEY POTS

A collection of elegantly designed European Chimney Pots are part of the Fabral architectural detail offering. Available in a variety of multiple heights and shapes, the pots enhance fireplace draft and functionality. They are lightweight, easy to install and are compatible with steel or masonry flues on wood or gas-burning fireplace systems.



CUSTOM COPPER

Copper is an elegant, long-lasting building material. Fabral Custom Copper offerings include custom fabrication to your specifications as well as the material in coils and flat sheets for on-site fabrication. Perfect for projects in historically sensitive districts, our FabralCore representatives will assist in engineering the correct solution.

ENVIRONMENTALLY CONSCIOUS

One of the most environmentally responsible things we can do is build for life. Using metal building materials ensures long-lasting solutions which will reduce the amount of building materials placed in landfills.



30 Year asphalt roof vs. 60 Year metal roof

FABRAL AND SUSTAINABLE BUILDINGS

Fabral metal substrates are excellent options for constructing sustainable buildings. Aluminum, stainless steel, Galvalume, copper and galvanized steel are recyclable materials. Additionally, Fabral metal products contain post-consumer as well as pre-consumer recycled content qualifying the project for LEED points. Since metal is a long-lasting product (up to 60 years), it's inherently a better option than products that do not last as long.



FABRAL FOR LEED

In addition to utilizing a high percentage of post consumer recycled content in their manufacture, metal roofing can be installed directly over an existing roof providing an extra layer of insulation and preventing the old roof from finding its way to the landfill. A key component in evaluating buildings for LEED is the ability to reduce or eliminate building materials from being deposited in landfills.



FABRAL REFLECTIVE ROOFING

One of the most beneficial aspects of metal roofing is its ability to reflect sunlight. Rather than absorbing into asphalt shingles, which can heat up a building, metal roofs have been known to reduce energy bills (during summer months) by up to 20%.

Finish Warranty

Availability
Northeast / Mid-Atlantic
Southern
Midwest
Western
Lifetime film integrity warranty for walls and roofs
30-year warranty against fade and chalk for walls and roofs
10-year edge rust warranty against acid rain
15-year edge rust warranty painted panels
25-year non-perforated warranty against acid rain for walls; 20 years for roofs
20-year non-perforated warranty
30-year corrosion warranty on aluminum
30-year prorated chalk and fade for walls & roofs
40-year film integrity for walls & roofs

WARRANTY

Fabral offers some of the most competitive, enduring warranties in the industry.

	Grandrib 3 Plus	Grandrib 3	TrustiRib	Grandrib 3 26 ga	Mighti-Rib	5V Crimp 26 ga	Prime Rib	ProClad	StrongClad	2 1/2" Corrugated Painted	1 1/2" SSR	Horizon S* (Climaguard*, Horizon 16*)
	■	■	■	■	■						■	■ *
		■	■	■	■	■					■	■ +
	■	■	■	■	■		■	■	■	■	■	■ **
		■	■	■	■					■		■ -
	●	●		●	●	●	●	●	●	●	●	●
	●	●		●	●	●	●	●	●	●	●	●
		●					●	●	●	●		
	●											
	●											
				●	●	●					●	●
			●									
			●									



FABRAL[®]

METAL WALL AND ROOF SYSTEMS

GRANDRIB 3 PLUS, GRANDRIB, TRUSTIRIB, MIGHTI-RIB, PRIME RIB, PROCLAD, STRONGCLAD, HORIZON CLIMAGUARD, FABRIB, ENDURACOTE, FABRAL, FABRAL CORE are registered trademarks of Euramax International, Inc.

UL is the trademark of UL LLC

Galvalume is a registered trademark of BIEC International Inc.

© Fabral 2015. All rights reserved.

Fabral.com