

2.4G Wireless Dimming & CCT Tunable LED Panel

Recessed Mount

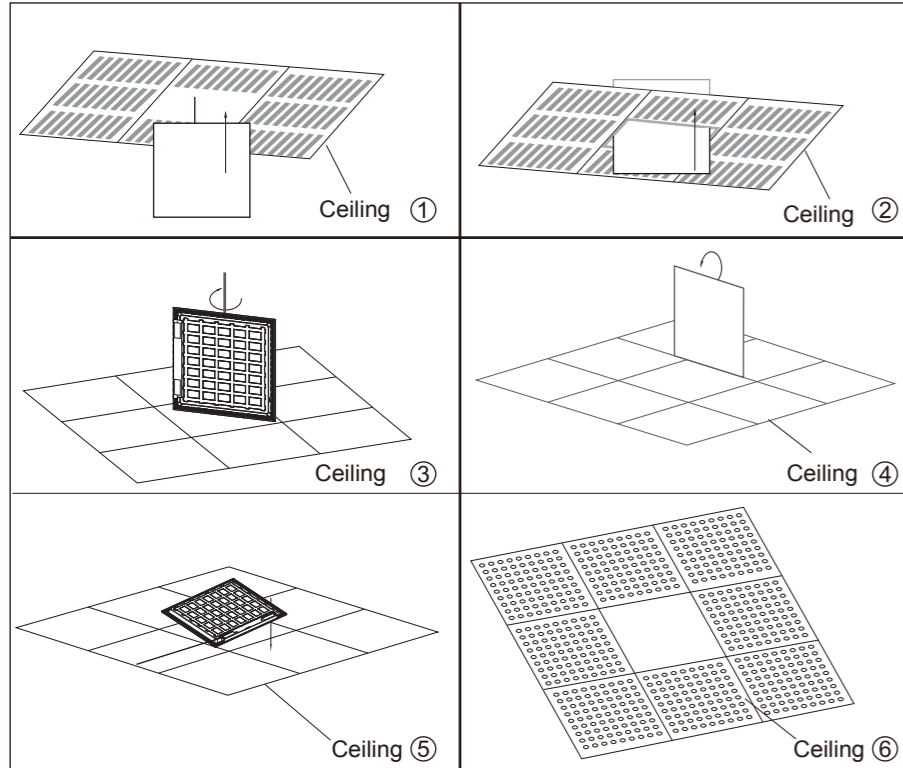

1. Prior to installation, make sure the drop ceiling frame can support the weight of the LED panel. Then connect the LED Panel Light to power to verify it operates. Plan to rotate the panel into a vertical diagonal position for installation into the drop ceiling frame.
2. Firmly secure the LED Panel Light's Internal Power Driver in place and insert the LED Panel Light above the drop ceiling. be sure the front of the panel is facing the ground.
3. Rotate the LED Panel Light (45° in the horizontal direction) to align the edge of the LED Panel Light to the drop ceiling frame.
4. Rotate the LED Panel Light (90° in the vertical direction) to align it with the recessed drop ceiling frame and to align the LED Panel Light radiating face towards the ground.
5. Embed the LED Panel Light into ceiling and adjust its position to align as flat as surrounding ceiling tiles.
6. Turn power ON and verify operation. Installation complete.

2.4G Wireless Dimming & CCT Tunable LED Panel

Suspension Mount

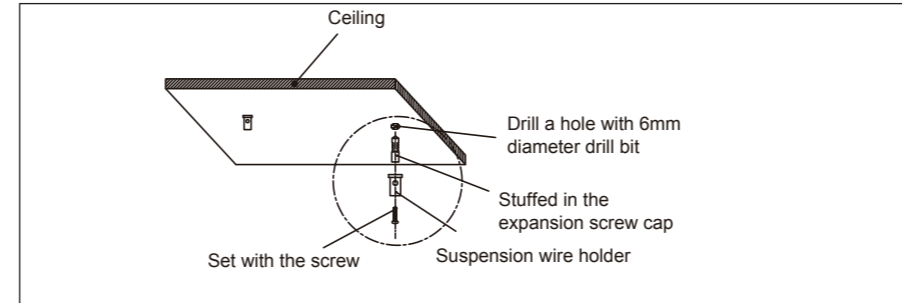

1. Setup the suspension wire connector and holder on the ceiling, make sure been safe!

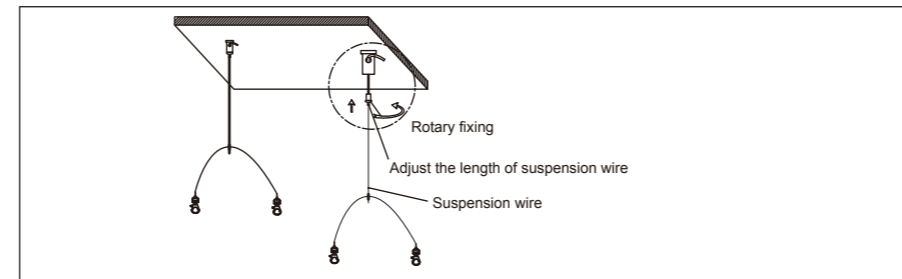

2. Connect the suspension steel wire on the ceiling completely and safely

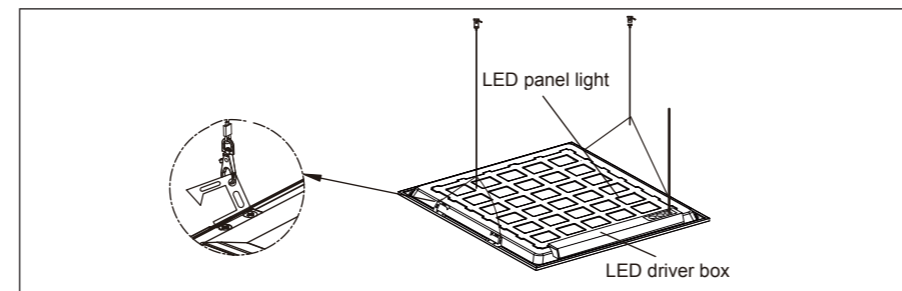

3. Hanger the LED panel light by the hook of suspension steel wire

We appreciate your business!

How'd we do?

Please take a moment to let us know. We will provide a FREE wall mount remote controller (mode # EEFPTL-RC-W) if you can register on our website: www.eleding.com and leave us your positive feedback at Home Depot.com. Please contact us via sales@eesgi.com to get the FREE remote!

We use your feedback to improve our operations for you and customers like you. Thanks!

2.4G Wireless Dimming & CCT Tunable LED Panel

Surface Mount

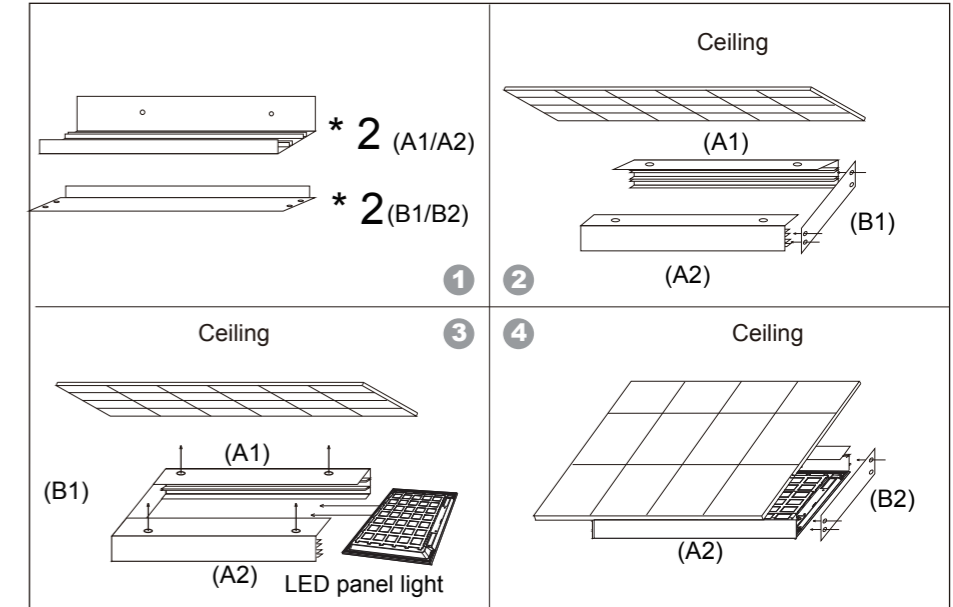

1. Parts A1,A2, B1,B2;
2. First must be assembled well A1, A2, and B1 (as illustrated)
3. As is shown in the figure A1 and A2 mount it with #8 screws with nylon swelling cap on the ceiling or on the wall, and then siding insert the panel light directly into the aluminum frame
4. Cover B2, to finish installation.

Option 1: Apply with RF wireless dimming CCT control All-in-One function (Default and recommended)

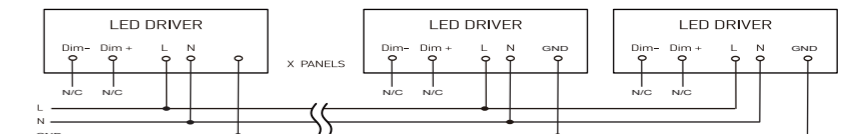

Option 2: Apply with hard wire 0-10V dimming function

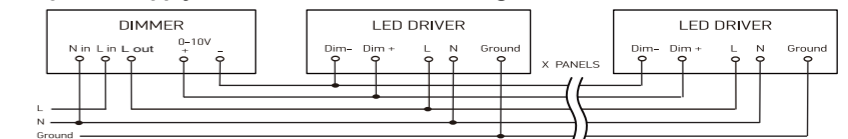

* Dimming and Color adjusted via RF Remote Control

2.4G Wireless Dimming & CCT Tunable LED Panel

Product description

For the following three models of products

EEBPTL2450W-RC, EEBPTL2235W-RC, EEBPTL1435W-RC

Product Introduction

The backlit LED over their complete surface brightly and highly consistent in white or warm white (according to CCT version). They are outstandingly suited for most standard drop ceilings, also can be used as elegant interior design elements directly on surfacing walls or hanging ceilings. Based on this panel illuminating tech, it will not produce much heat and lower the cooling than average LED lights. The consistently illuminated surface almost has no glare, shadows and has a highly modern appearance. The use of efficient, long-life and high quality LEDs means that user will save outstanding electricity bill and a lot maintenance labor cost in long run.

Product Features

Long life
Its service life is significantly longer than fluorescent lamps or other old dated light sources.

Ecological
Saves electricity and low carbon.

Saves energy
Consumes less energy via use of efficient LEDs.

The Light quality
Very uniform light distribution in the complete surface.

Elegant
Modern ultra thin design, healthy light, no UV component and almost no glare.

Applications

The most common places you are likely to find the panel lights include: Hospitals, Laboratory, Clinics, Schools/classrooms, Conference Rooms, Offices, Restaurants, Working Stations and etc.



Attention

- Do not allow to use scouring powder, abrasive powder, oil and acid alkaline type detergent.
- Do not spray air fresheners, disinfectant, cleaning organic solvents directly on light-emitting surface.
- Do not allow wire connectors to have contact with water.
- Do not allow sharp objects to scratch the lamp, especially the light-emitting surface.
- Consult a qualified electric tach or contractor to ensure work on right.

2.4G Wireless Dimming & CCT Tunable Remote Controller

THE HANDHELD REMOTE CONTROL



	ON Turn on OFF Turn off
	The Remote Control provides flexible adjustments for dimming the LED Panel Light and selecting the desired color temp. Handheld remote control should operate with wall main ON-OFF switch
	After selecting the desired settings, push the Remote Control OFF button to save them as default settings until the next setting change. Then the wall main switch ON-OFF as normal operation in most time
	How to set the initial Remote Control code to operate the LED Panel Light(s) Turn OFF the wall switch or circuit breaker. Then press and hold the ID button until the tiny RED LED indicator is flashing on top of the Remote Control. Then turn ON the wall switch or circuit breaker and release the ID button after the LED Panel Light(s) flashes. Setup complete.
	How to erase the Remote Control code to set up different LED Panel Light(s) Press the button ID + simultaneously, then turn on the light, the light flash to finish releasing the code on the lights.
	How to Control Groups of LED Panel Lights After enabling the initial Remote Control code to operate the LED Panel Light(s), the remote control can be programmed to separately control up to four LED Panel Light groups (1, 2, 3, 4) as follows: Turn OFF the wall switch or circuit breaker for the desired Group 1. Press "1" button, Turn ON the wall switch or circuit breaker for the desired Group 1 and release the Group "1" button after the Group 1 LED Panel Lights flash. Group 1 programmed. Repeat process to set up other groups.
	How to Save the default brightness level and color temp Select the desired brightness level and color temp. Then press and hold the SAVE button for a few seconds until the LED Panel Lights shut OFF. The settings are now saved. Each time you turn ON the wall switch or circuit breaker, the LED Panel Lights will utilize the saved brightness level and color temp
	All Groups are selected
	5000K 5000K 3500K 3500K 4000K 4000K 3000K 3000K
	25% 25% brightness 75% 75% brightness 50% 50% brightness 100% 100% brightness
	Increase brightness Decrease color temperature Decrease brightness Increase color temperature

Power OFF the LED Panel Light and then power it ON. The last saved brightness (which is saved by the button "SAVE") and the last saved color temperature (which is saved by the button "SAVE" or "OFF") will be displayed by default. The default factory setting of the light is 100% brightness and 4000K.

eSenLite®

EE Systems Group, Inc. 12346 Valley Blvd, Suite A El Monte California U.S.A. 91732

2.4G Wireless Dimming & CCT Tunable Remote Controller

THE WALL TYPE REMOTE CONTROLLER

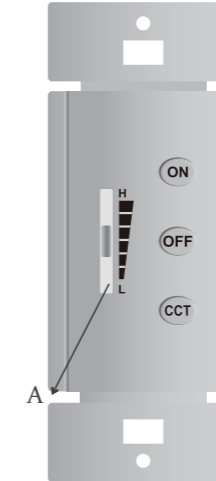

	ON Turn on OFF Turn off
	Wall-type remote controller cannot be used directly as a switch, it should be used together with the switch.
	Long pressing (6-9 seconds) the button "ON" until the light goes out, the current brightness and color temperature are automatically saved. Turn off lights then turn on, the last saved brightness and color temperature will be displayed by default.
	Turn off the light to save the current color temperature then turn on the light, the last saved color temperature will be displayed by default.
	Light code combination matching button Pressing the "ON + OFF" buttons simultaneously will keep the remote controller's indicator on, turn on the light and release the buttons after the light has been on for 2s completing the matching process. Matching code for several lights together is available. If you need to use both hand-hold controller and wall controller for the same light, please don't use this function, directly use the following copy function.
	Brightness adjuster
	Press the "CCT" button, the color temperature will cycle between 3000k/3500k/4000k/5000k. After shutting down/turning off the current color temperature will be saved.

The matching method of hand-hold remote controller and wall-type remote controller, the wall controller can copy some of the functions of the hand-hold controller by the following method.

NO	Grouping	Hand-hold controller	Wall-type controller
1	1	1 + ID	ON+CCT
2	2	2 + ID	ON+CCT
3	3	3 + ID	ON+CCT
4	4	4 + ID	ON+CCT
5	ALL	ID	ON+CCT

After 10s of each operation the controller will enter standby power saving mode. If you need to make adjustments, simply press the "ON" button, the indicator will flash to show it is working. (If the controller is under working mode, the indicator will flash no matter which button is pressed).

Power the light off then power it on, the last saved brightness (which is saved by the button "ON") and the last saved color temperature (which is saved by the button "ON" or "OFF") will be displayed by default. The default factory setting of the light is 100% brightness and 4000K.

eSenLite®

EE Systems Group, Inc. 12346 Valley Blvd, Suite A El Monte California U.S.A. 91732