

# How to Install Your Armstrong® Suspended Ceiling



## SAFETY TIPS:

- Safety glasses and gloves are recommended to be worn during installation. Metal grid components can be sharp.
- When working overhead, make sure your work area is clear of obstructions and that your ladder is stable.

## IMPORTANT INFORMATION:

- Store and install panels in areas with temperature and humidity ranges that meet specific product warranty requirements.
- Remove panels from the cartons 24 hours before installation and allow them to adjust to normal interior conditions of the area where installation will take place.
- Never install ceiling panels below an existing ceiling that contains embedded radiant-heat coils.
- Do not apply loose fill or batt insulation so that it rests directly on the panels.
- Keep hands clean to avoid smudges on the finished ceiling.
- Always cut mineral fiber or fiberglass ceiling panels face up with a sharp utility knife.
- Main beams should be installed perpendicular to the joists.
- Main beams are typically installed on 4' centers. If your room configuration is unusual, you may require additional components.
- To allow for ceiling tile installation and accessibility, the minimum drop is 3" with traditional hanger wire or 2.5" with QuickHang™ grid hooks. *(QuickHang instructions are notated by a gray background)*

**NOTE:** QuickHang hooks and brackets are available through select retailers. Visit [ceilings.com/stores](http://ceilings.com/stores) for where to buy.

- Installations with light fixtures will likely require additional clearance and support. Consult the light manufacturer's instructions for details.
- When installing below an existing drywall ceiling, a minimum 4" drop is required to install panels. Joists will need to be located and marked.

**NOTE:** QuickHang hardware cannot be used below drywall ceilings.

## TOOLS NEEDED TO INSTALL YOUR CEILING

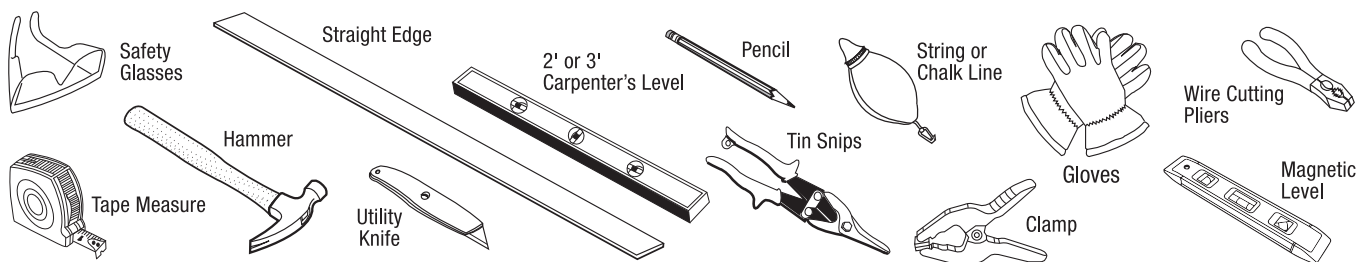

## PLANNING YOUR ARMSTRONG CEILING

Main beams typically run perpendicular to the joists. If you have an existing drywall ceiling you will need to locate and identify the joist direction.

## LOCATE HIDDEN JOISTS TO INSTALL WIRE FASTENERS

Use either a stud finder or locate hidden joists by tapping on the ceiling until you hear a solid thud. Drive a nail in here. Repeat this to locate other joists and determine their direction. Mark the joist locations with chalk lines.

- Find joists **(A)**.
- Drive nails to find exact *center line* of joists.
- Snap chalk line for each joist **(B)**.

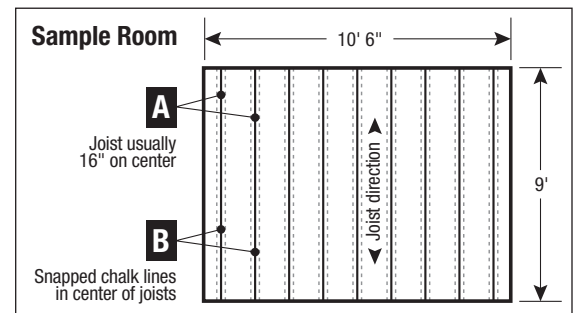

# How to Install Your Armstrong® Suspended Ceiling



## SAMPLE PANEL LAYOUT

### Determine panel layout

For best appearance, border panels should be the same size on the opposite sides of the room and as large as possible. Use your room dimensions and follow the formula in the worksheets below.

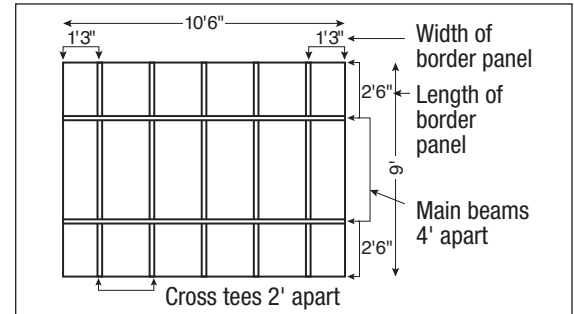

### Sample worksheets using 2' x 4' panels in a 9' x 10' 6" room

Determine length of border panels	
9'	Room length
÷ 4'*	Panel length
(2) 4' panels + 1 foot remainder	Tiles across room
1'	Remainder
+ 4'*	Panel length
5'	Tile borders (both sides)
5'	Number of panels
÷ 2	Border panel length
2' 6"	

Determine width of border panels	
10' 6"	Room width
÷ 2'	Panel width
(5) 2' panels + 6 inches remainder	Tiles across room
6"	Remainder
+ 2'	Panel width
2' 6"	Tile borders (both sides)
2' 6"	Number of panels
÷ 2	Border panel width
1' 3"	

\*Use 4-ft for 2-ft x 4-ft panel, 2-ft for 2-ft x 2-ft panel

## STEP 1

### INSTALL WALL MOLDING

- Mark the desired height of your new ceiling on the wall **(A)**.
- Add the height of the Wall Molding above the desired ceiling height and mark a level line around 3 walls **(B)**.
- Use a string line to mark the 4th wall.
- Fasten wall molding to the wall studs with appropriate fastener. **(C)**.
- If nailing molding directly to wall is not possible (*for example, a solid concrete or stone wall*), hang a section of main beam next to the wall as a substitute for regular wall molding using hanger wire **(D)** or the QuickHang hardware **(E)**.

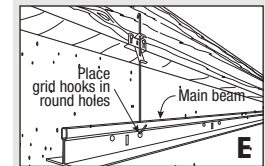
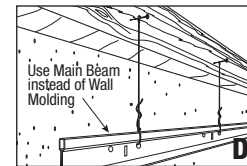
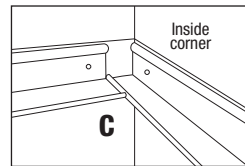
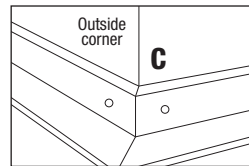
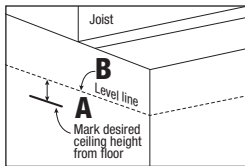

Using Hanger Wire

Using QuickHang Grid Hooks

## STEP 2

### INSTALL HANGER WIRE OR QUICKHANG GRID HOOKS

**IMPORTANT:** The first row of main beams in a 2' x 4' panel installation should be the border panel size from the wall.

In a 2' x 2' panel installation, the first main beam can be the border panel size or the border panel + 24" from the wall.

**EXAMPLE:** See Sample Room Hanger Layout – 2' 6" from the wall for a 2' x 4' panel. QuickHang brackets should not be spaced more than 4' apart in any direction.

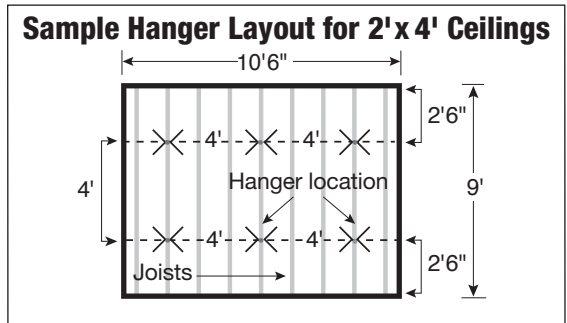

# How to Install Your Armstrong® Suspended Ceiling

## Traditional Hanger Wire

- Snap Chalk Line for Main Beams 4' Apart (A).
- Screw in Wire Fasteners 4' Apart (B).
- Wrap hanger wire securely around itself 3 times (C).

**NOTE:** Additional hanger wires may be needed to support light fixtures.

- Measure up 7/8" from the bottom of the molding. Drive nail into wall just above molding. Do the same on other side of room. Stretch a string from nail to nail along a row of wires (D).
- Swing hanger wires over to string and bend each one at 90° where they touch the string (E).
- Stretch additional strings to pre-bend other hanger wires, to help level entire ceiling.
- Remove Leveling String(s) after pre-bending wires.

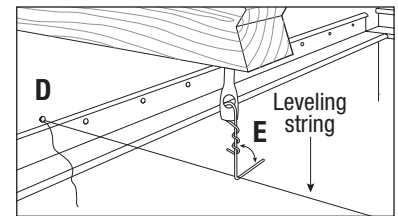
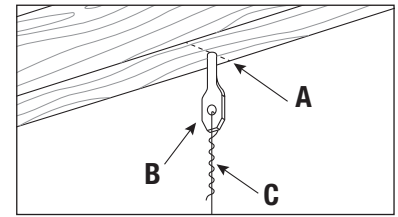

## QuickHang™ Hardware

### FOR RESIDENTIAL USE ONLY:

**NOTE:** The QuickHang™ hardware is designed to work with solid wood and engineered wood joists in residential ceiling applications. QuickHang hardware allows for ceiling drops from 2.5" to 6" with 6" grid hook kits or 2.5" to 12" with 12" grid hook kits, below the bottom of the joists. QuickHang hardware is not for use on finished drywall ceilings.

### SAFETY TIPS

- Do not cut QuickHang hooks. If the hook needs to be shortened due to an obstruction, the top portion can be bent by hand or with pliers.

**TIPS:** Measure and mark your joists prior to installation. Use a string line or chalk line to align marks perpendicular to joists across the room.

### How to Install the QuickHang™ Hooks and Brackets

- Hang your string line or snap your chalk line to position your main beams 4' apart.
- Make a 1" long vertical mark up the side of each joist where a bracket will be located (A).
- Use the center hole in the brackets to line the brackets up with your marks (B).
- Hammer in the 2 tabs for a temporary hold (C).
- Nail the bracket to the joist through the two openings above the hammer tabs with the nails included in the kit (D).  
– OPTIONAL: You can also secure the bracket to the joist with a single #5 Wood Screw through the center hole (screws not included in kit hardware.)
- With the bracket securely attached to the joist, insert the grid hook using the diamond-shaped holes in the brackets. Thread the small end of the hook, from the back, through the lower hole (E). Push the hook up and rotate to thread through the upper hole, squeezing the spring tabs to allow the wire to go through (F).

**IMPORTANT:** Do not cut QuickHang hooks. If the hook needs to be shortened due to an obstruction, the top portion can be bent by hand or with pliers.

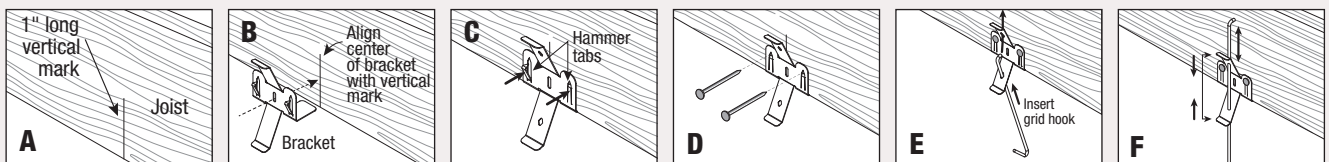

- Turn all hooks in the same direction, parallel to the joists.
- Set the hooks at about the same height; the bottom of the hooks should align with the top of the wall molding.
- To adjust the height of the hook, squeeze the upper and lower spring tabs while lifting or lowering the hook.

**NOTE:** You will do final leveling once all of the grid is installed.

# How to Install Your Armstrong® Suspended Ceiling

## STEP 3

### INSTALL GRID

#### Prepare and Hang Main Beams

- To prepare the first main beam, trim the end of the main beam so that a cross tee slot on the main beam is the border panel distance from the wall (**B**).  
(This creates the proper border tile opening.)

**TIP:** Cut the top of the grid first with tin snips and then bend the grid open and cut the face of the grid (**A**).

- Place the cut end of the first main beam on the wall molding and using the round holes in the grid, hang main beams on the hanger wire or hook perpendicular to joists. For installations using traditional hanger wire, after inserting the wire through the round hole, bend it up and wrap the wire around the hanger wire around itself three times. Do this same step with the next main beam running parallel 4' away along the wall.

#### Prepare and Cut Border Cross Tees

- Stretch a string line from one end of the room to the other below the wall molding and along the edge furthest from the wall of the main beams (**A**). (*illus. A*)
- Install your first cross tee in the main beam cross tee slot that is your border panel distance from the wall.
- Hold the end of your border cross tee against the wall (**B**). (*illus. A*) Mark and cut the cross tee where it crosses the string line.
- Insert the uncut end of the cross tee into the main beam through the rectangular hole and rest the cut end of the tee on the wall molding.
- Cut the second border cross tee to length and insert it.
- Temporarily fasten the cross tees to the wall molding with a clamp or tape so they do not move.

#### Squaring the Grid

To achieve the best end results, it is important to make sure your grid is square at this point in the installation. This will allow you to adjust if changes are required.

**NOTE:** When connecting two cross tees in the same rectangular hole of a main beam, insert the second tee into the slot by passing on the **right side** of the already installed cross tee.

**TIP:** Installing cross tees is easier if the tee is inserted into the rectangular slot at a downward angle from above the grid plane. Listen for an audible click to ensure a good connection.

- Install two 4' cross tees between the two main beams in line with the first two border tees (**C**). (*illus. B*)

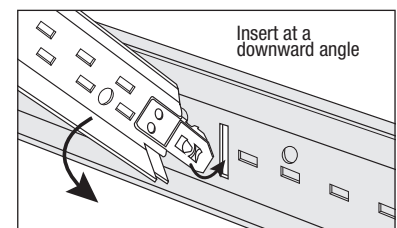
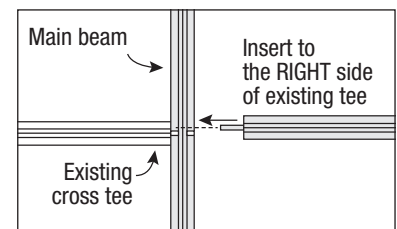
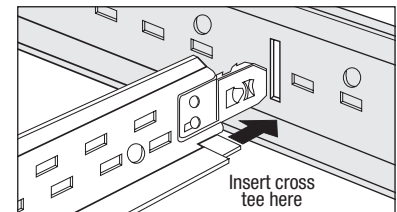
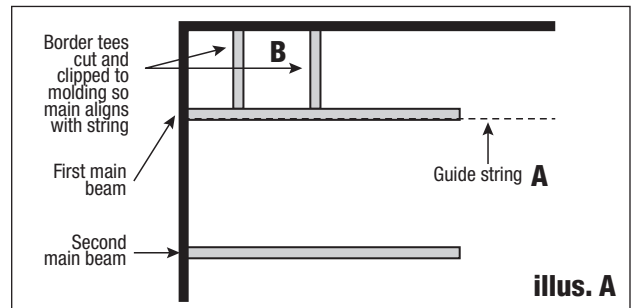
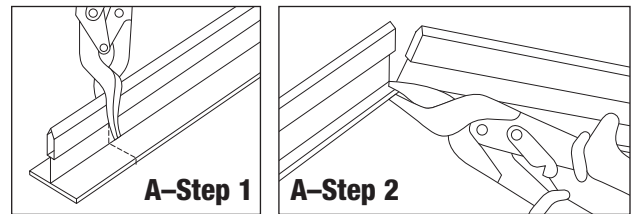
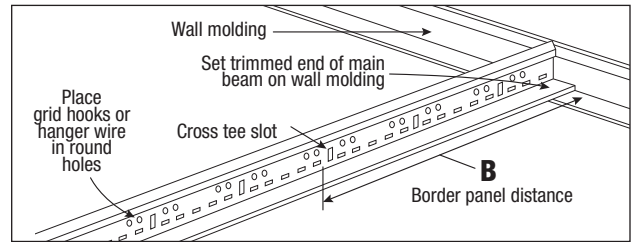

# How to Install Your Armstrong® Suspended Ceiling

- To check that your grid is square, measure across the diagonals of the 2' x 4' opening. The measurements will be the same if the grid is square. If the measurements are not the same, trim one of the mains further until the diagonals are equal. (**illus. B**)

## Installing Remaining Grid & Leveling the System

- Complete the first two rows of main beams by hanging main beams from the hooks and joining their ends together. Listen for an audible click to ensure a good connection. (**illus. C and illus. D**). At the far end of each of these first two rows, you'll need to cut both main beams to rest on the wall molding.

**TIP:** Use the left-over ends of the cut main beams to start additional rows of main beams.

- Cut additional border cross tees between the wall and first row of main beams.
- If you have additional rows of main beams to install, stretch a second string from one side of the room to the other aligning it with the first 4' cross tee as shown (**D**). (**illus. B**)
- This second string will be your guide for cutting the remaining rows of main beams. Just measure from the end wall to the string to determine the distance for the first rectangular cross tee slot you will use.

**NOTE:** You must line up cross tee slots for the grid to be square!

- Install all remaining main beams and 4' cross tees.
- Measure and cut border cross tees along the last wall.
- Now that your grid is installed, it's time to check or do final leveling.

## Final Leveling

- Start by attaching a magnetic level to the bottom of a main beam located in a corner of the room. Note: Main beam should rest on wall molding.
- Systems installed with traditional hanger wire should be level already. If additional leveling is needed, untwist the hanger wires, raise or lower the grid slightly, re-bend and twist the wires.
- Systems using QuickHang hardware, hold the main beam, squeeze the spring tabs on the QuickHang bracket to allow the hook to slide up or down (**F**). Releasing the tab will lock the hook in place.
- Working from the corner of your room, check and level cross tees and main beams until the system is level.

**TIP:** For additional guidance, see our video online at [ceilings.com/installation](http://ceilings.com/installation).

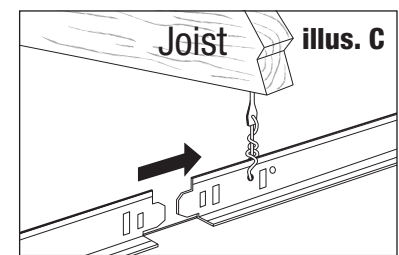
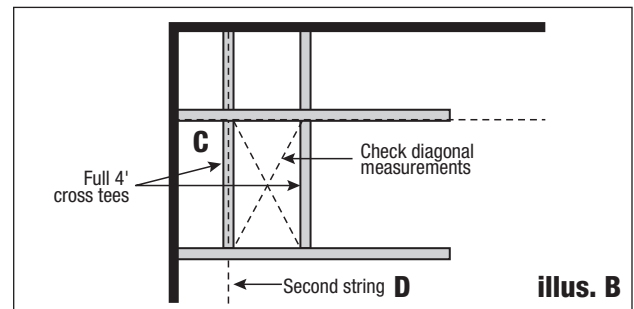

Traditional Wire Hanger

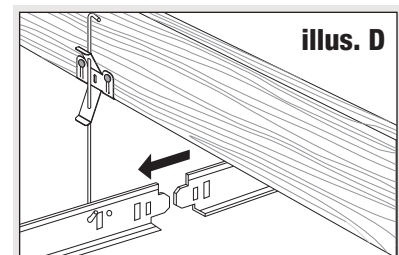

QuickHang Grid Hooks

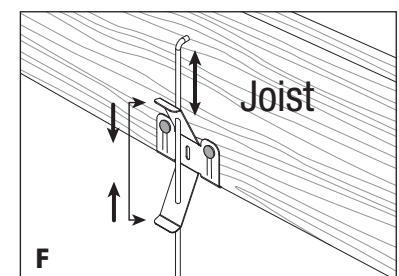

# How to Install Your Armstrong® Suspended Ceiling

**Armstrong**  
CEILINGS

**STEP  
4**

## INSTALL CEILING PANELS

### Installing Panels

- Lift panel at angle up through the grid; drop into place **(A)**.
- TIP:** If there's an obstruction in the area where you are inserting a ceiling tile, you may need to lift the ceiling tile through an adjacent opening and gently move it across the back of the grid into place.
- Trim border panels using a straight edge; panels should be cut face side up **(B)**. For tegular tiles, you will need to cut the edge that's resting on the wall molding to allow it to lay flat.

### Cutting "Tegular"/"Recessed Grid" ceiling border panels

- Trim tegular edge border panels to the same dimensions as for flat panels. The tegular edge detail must now be cut into the panel.
- Set the panel into the grid. Draw a light pencil line on the panel using the wall molding as a guide **(C)**.
- Remove the panel. Use a sharp utility knife and straight edge to cut halfway through the panel from the face side along the pencil line **(D)**.
- Lay the utility knife on its side next to the panel and, with the panel face up, cut in at blade height for a reveal cut **(E)**.
- Remove the cut edge. If the cut edge of the panel is visible, paint with a flat white latex paint.
- Fit the panel into the grid.

For additional information on installing suspended ceilings, please visit our website at [ceilings.com](http://ceilings.com) or call Techline at 1-877-ARMSTRONG (276-7876).

### Limited Warranty

For warranty information, please visit [ceilings.com/warranty](http://ceilings.com/warranty).

**Precautionary Measures:** During the installation, be certain that the work site is well ventilated and avoid breathing dust. Avoid contact with skin or eyes. Wear long-sleeve, loose fitting clothes, gloves, and eye protection. Cut and trim with knife, razor, or hand saw. Do not cut with power equipment unless the equipment has an attached dust collector. The work site air quality should be assessed and if conditions require, a NIOSH approved respirator should be worn.

This product may contain small levels of crystalline silica. Exposures to respirable crystalline silica are not anticipated based on industrial hygiene testing on workers installing acoustical ceiling panels for an 8-hour work day and are not expected during the normal use of this product. Specific worksite conditions must be taken into consideration to determine if workplace industrial hygiene testing is necessary. Prolonged and repeated exposure to airborne crystalline silica can result in lung disease and/or lung cancer. Panels do not release respirable dust in their installed state. **For additional information, refer to the Safety Data Sheet at [www.armstrongceilings.com](http://www.armstrongceilings.com).**

**First Aid Measures:** If eye or skin contact occurs, flush with plenty of water for at least 15 minutes and remove contaminated clothing. After installing material, wash with warm water and mild soap. Wash work clothes separately from other clothing. Rinse washer thoroughly.

Armstrong World Industries, Inc. 2500 Columbia Ave, Lancaster, PA 17603; 255 Montpelier Boul. Quebec N4N2G3  
1-877-276-7876

