

# HOME DECORATORS COLLECTION

Model #WH100-23I2D-R  
WH100-26I2D-R

## USE AND CARE GUIDE

### COMBINATION ELECTRIC FIREPLACE/HEATER

Covered by one or more of the following US Patents: 10,451,235 / 10,371,333 / 10,520,149 / 10,731,810.  
Additional US and International Patents Pending.

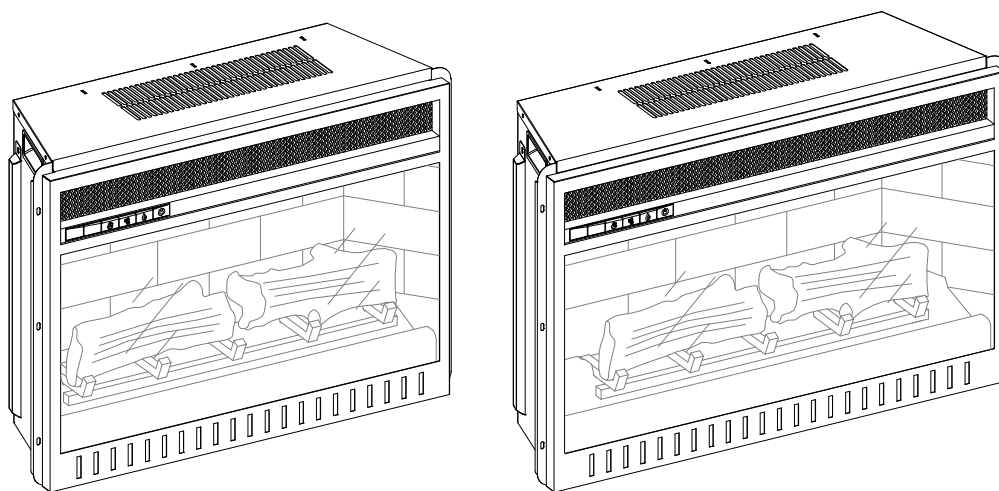

#### **HEATER DEFAULT SETTING:**

The default factory setting for your thermostat is 82 degrees. If your room temperature is already 82 degrees or above, then your heater will shut OFF after about 3 minutes. See thermostat directions for how to adjust the temperature settings in order to keep your heater ON until your desired room temperature is reached.

Questions, problems, missing parts? Before returning to the store,  
call Home Decorators Collection Customer Service  
8 a.m. - 7 p.m., EST, Monday-Friday  
9 a.m. - 6 p.m., EST, Saturday

**1-800-986-3460**

**[HOMEDEPOT.COM/HOMEDECORATORS](http://HOMEDEPOT.COM/HOMEDECORATORS)**

**QuantumFlame®**

Quantum Flame and the Quantum Flame logo are registered trademarks of Living Style (B.V.I.) Limited. All rights reserved.

#### THANK YOU

*We appreciate the trust and confidence you have placed in Home Decorators Collection through the purchase of this electric fireplace/heater. We strive to continually create quality products designed to enhance your home. Visit us online to see our full line of products available for your home improvement needs. Thank you for choosing Home Decorators Collection!*

# Table of Contents

<b>Table of Contents</b> .....	2	Package Contents .....	4
<b>Safety Information</b> .....	2	<b>Operation</b> .....	5
Important Safety Information .....	2	<b>Using the Remote Control</b> .....	7
Grounding Instructions .....	3	<b>Care and Maintenance</b> .....	9
<b>Warranty</b> .....	3	<b>Troubleshooting</b> .....	10
<b>Pre-Operation</b> .....	4		
Electrical Specifications .....	4		

# Safety Information

## IMPORTANT SAFETY INFORMATION

PLEASE READ ALL OF THE INFORMATION IN THIS OPERATING MANUAL, INCLUDING ALL SAFETY, OPERATING, AND MAINTENANCE INFORMATION. TO AVOID THE POTENTIAL RISK OF FIRE, ELECTRIC SHOCK, OR INJURY TO PERSONS, USERS SHOULD FOLLOW THE DIRECTIONS AND WARNINGS IN THIS MANUAL.

1. Read all instructions before using this heater.
2. Do not use this heater outdoors.
3. This heater is not intended for use in bathrooms, laundry areas and similar indoor locations. Never locate the heater where it may fall into a bathtub or other water container.
4. Do not run the power cord under carpeting. Do not cover the power cord with throw rugs, runners, or the like. Arrange the power cord away from traffic areas and where it will not be tripped over.
5. To disconnect the heater, turn controls to off, then remove the plug from the outlet.
6. Connect to properly grounded outlets only. Avoid the use of an extension cord because the extension cord may overheat and cause a risk of fire. However, if you have to use an extension cord, the cord shall be No.14 AWG minimum size and rated not less than 1875 watts.
7. To prevent a possible fire, do not block firebox air intakes or the exhaust in any manner. Do not operate the firebox on soft surfaces, like a bed, where openings may become blocked.
8. There is a thermostat limiter inside the heater. When the inner temperature over heats or abnormal heating occurs, the thermostat protective device cuts off the power supply to avoid fireplace damaged or risk of fire.
9. Use this heater only as described in this manual. Any other use not recommended by the manufacturer may cause fire, electrical shock, or injury to persons.

## SAVE THESE INSTRUCTIONS



**WARNING:** There are no user serviceable parts inside the fireplace/heater. If the unit appears to malfunction, turn the unit off and unplug the unit from the wall immediately, and contact Customer Service at 1-800-986-3460.



**WARNING:** This heater is hot when in use. To avoid burns, do not let bare skin touch hot surfaces. If provided, use handles when moving this heater. Keep combustible material, such as furniture, pillows, bedding, papers, clothes and curtains at least 3 ft. (0.9 meters) from the front of the heater and keep them away from the sides and rear.



**WARNING:** Extreme caution is necessary when any heater is used by or near children or invalids and whenever the heater is left operating and unattended.



**WARNING:** Always unplug the heater when not in use.



**WARNING:** Do not operate any heater with a damaged cord or plug or after the heater malfunctions, has been dropped or damaged in any manner. Return the heater to an authorized service facility for examination, electrical or mechanical adjustment, or repair.



**WARNING:** Do not insert or allow foreign objects to enter any ventilation or exhaust openings as this may cause an electric shock or fire, or damage the heater.



**WARNING:** A heater has hot and arching or sparking parts inside. Do not use in areas where gasoline, paint, or flammable liquids are used or stored.



**CAUTION:** While the heater is in use, the top center of the fireplace can get hot to the touch, and may cause serious injury or burns. Always supervise small children around the fireplace/heater. Do not place any cloth or decorations over the heater outlet of the fireplace, or otherwise obstruct the heater outlet of the fireplace, as this may cause a fire and serious injury may result.

# Safety Information (continued)

## GROUNDING INSTRUCTIONS



**DANGER:** Improper connection of the equipment-grounding conductor can result in a risk of electric shock. Check with a qualified electrician or serviceman if you are in doubt as to whether the product is properly grounded. Do not modify the plug provided with the product. If it will not fit the outlet, have a proper outlet installed by qualified electrician.

This product must be grounded. If it should malfunction or breakdown, grounding provides a path of least resistance for electric current to reduce the risk of electric shock. This product is equipped with a cord having an equipment-grounding conductor and a grounding plug. The plug must be plugged into an appropriate outlet that is properly installed and grounded in accordance with all local codes and ordinances.

This heater is for use on 120 volt circuits and has a grounded plug. An adapter is available from your local electronics store or online supplier for connecting three-blade grounding type plugs to two-slot receptacles. The green grounding lug extending from the adapter must be connected to a permanent ground such as a properly grounded outlet box. The adapter should not be used if a three-slot grounded receptacle is available.

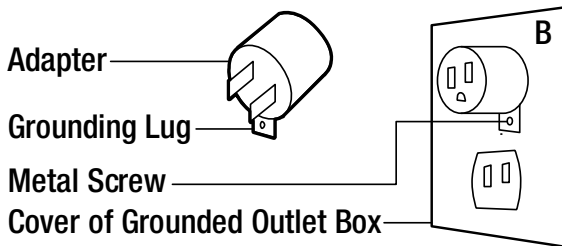
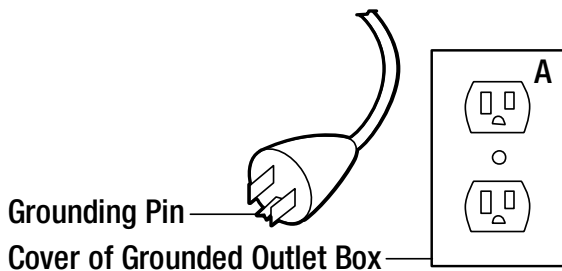

## Warranty

We are confident that you will be delighted with this purchase. Should this product be defective in workmanship or materials, or fail under normal use, we will repair or replace it for a period of up to one (1) year from date of purchase.

This warranty gives you specific rights and you may also have other rights which vary from state to state.

Contact the Customer Service Team at 1-800-986-3460 or visit [www.HomeDepot.com/homedecorators](http://www.HomeDepot.com/homedecorators).

# Pre-Operation

## ELECTRICAL SPECIFICATIONS

- **Voltage:** 120 V AC, 60 Hz
- **Watts:** 1500 Watts

## PACKAGE CONTENTS

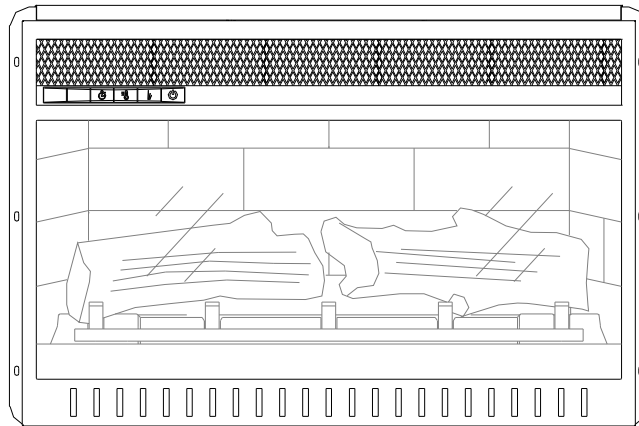

**A**

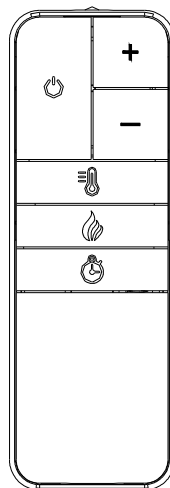

**B**

Part	Description	Quantity
A	Fireplace	1
B	Remote control	1

# Operation

## 1 Identifying the control panel

- The control panel is located on the top left corner of the fireplace/heater unit.
- The control panel contains the display unit (1), function indicator (2), timer function (3), heater control (4), flames control (5), and main power (6).
- The display unit (1) displays information about the flame level, timer, and current temperature.

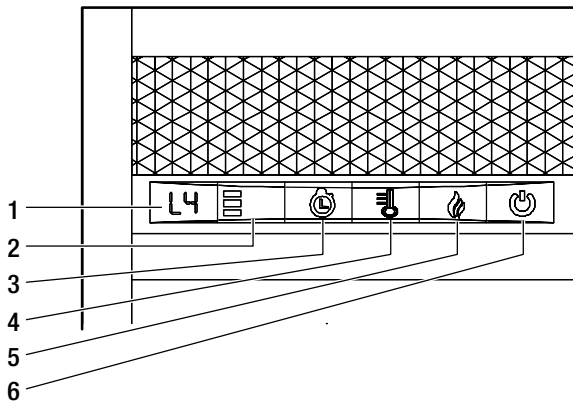

## 2 Understanding the function indicator

- The function indicator (2) has three square LEDs – red, green, and blue. The red LED indicates that the Fahrenheit temperature heating function is running, the green LED indicates that the Celsius temperature heating function is running, and the blue LED indicates that the timer function is engaged.
- To the right of the three LEDs, is the infrared receiver module which communicates with the remote control to control the heater.

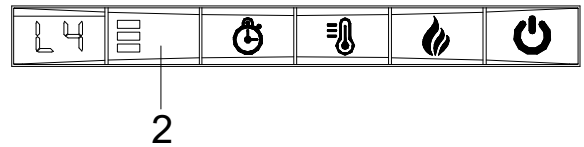

## 3 Using the timer function

- The timer button (3) allows you to set the amount of time you want the fireplace/heater to run. The timer button (3) operates both the flames and the heater function. If the heater is operating when the timer is set, then the heater is on the timer. If the flames are operating, then the timer will control the flames. If both the heater and flames are operating with the timer set, then the timer controls both the flames and the heater. Pressing the button in sequence will set the timer for a set interval. This interval period is shown in the display (1), and the blue LED light turns on to show that the timer function is engaged. The set intervals are displayed in this table. The timer starts after you select your preferred interval and release the button; note that the display and blue light will turn off after a few seconds. There is no clock function for turning the heater or flames on or off at a specific time.

Button Press	Timer Interval	Display
1st press	30 Minutes	30
2nd press	1 Hour	1h
3rd press	2 Hours	2h
4th press	3 Hours	3h
5th press	4 Hours	4h
6th press	5 Hours	5h
7th press	6 Hours	6h
8th press	OFF	None

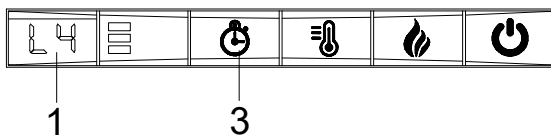

# Operation (continued)

## 4 Using the heater control



**NOTE:** The heater default temperature is set to 82 degrees Fahrenheit. If your ambient room temperature is above 82 degrees, then your heater will automatically shut off after few minutes. Adjust your heater thermostat (see below) to a higher temperature in order to keep your heater ON above 82 degrees.

- Pressing the heater button (4) will turn on or off the heat and set the temperature in the thermostat. If you turn off the heater by the main power button (6), the unit will hold your preferred temperature setting in the memory. When the power is turned back on, the heater will turn on at the same setting. There is no speed setting for the heater blower.
- **To convert from Fahrenheit to Celsius:** With the heater on, press and release the heater button (4) so that the display (1) and LED function indicator (2) lights turn on (if they are not already on). Then gently press and hold the main power button (6) for five seconds to enter temperature converting mode. The LED indicator flashes five times in red color then changes to green. Green indicates Celsius mode, and Red indicates Fahrenheit mode. In this converting mode, the display (1) flashes. Repeat the same process to convert Celsius temperature into Fahrenheit temperature.
- **To set the thermostat temperature:** Press the heater button multiple times to cycle through the temperature settings, starting at 82°F down to 62°F, then Always OFF or Always ON. (27°C - 17°C - OFF - ON). After you release the heater button, your preferred setting will be flashing. Once it stops flashing, and the display goes dark, then the thermostat will be set at your preference (and kept in memory). Note that the "ON" setting keeps the heater always on until the user powers off the unit or the safety sensor turns off the heater to prevent overheating.
- **To turn OFF the Heater while keeping the Flames ON:** Press the heater button until you see "OFF" in the Control Panel display (1). This indicates the Heater is "OFF". Flame settings and other features continue to operate as normal.
- **Heater Lock (safety feature):** To lock the heating function in the OFF position, with the main power button on, press and hold the heater button (4) for ten seconds. The log lights flash several times to indicate that the heater function is locked. In this mode, there is no heating function but only glowing logs and normal flame control operation.
- To unlock the heating function, press and hold the heater button (4) for ten seconds. The log lights flash several times and then normal heating function mode is turned on.

**NOTE:** After the heater function or power is shutoff the blower will continue to run for several minutes to cool the internal components.

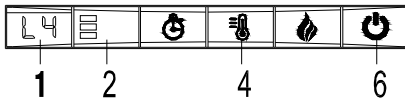

## 5 Using the flame control

- Press the flame button (5) to set the flames for different levels of flame brightness. These flame levels are shown in the display (1). The flame settings are as follows:

Button Press	Flame Level	Display Value	Fireplace Appearance
1st press	High	L4	Flames Highest, Logs Glow Highest
2nd press	Medium	L3	Flames Medium, Logs Glow Medium
3rd press	Low	L2	Flames Low, Logs Glow Low
4th press	Flames Off	L1	Flames Off, Logs Glow Highest
5th press	All Off	None	Flames Off, Logs Off

- Regardless of the previous flame setting, when powered off by the main power button, the flames will come on in L4 mode (High) when you turn the heater on.
- **Log Glow Mode:** To lock the flame function in the OFF position, with the flame in L4 mode, press and hold the flame button (5) for five seconds. The log lights flash several times to indicate that the flame function is locked. In this mode, there are no flames but only glowing logs. Pressing the flame button in sequence will set the logs for different levels of log brightness. The logs brightness levels are shown in the display (1). The logs settings are as follows:

Button Press	Flame Level	Display Value	Fireplace Appearance
1st press	Flames Off	L4	Logs Glow Brightest
2nd press	Flames Off	L3	Logs Glow Medium
3rd press	Flames Off	L2	Logs Glow Low
4th press	Flames Off	L1	Logs Glow Brightest
5th press	All Off	None	Logs Off

## Operation (continued)

- To unlock the flame function, press and hold the flame button (5) for five seconds. The log lights flash several times and then both flame lights and log lights turn on.

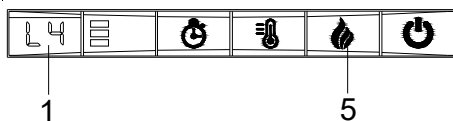

## 6 Using the main power button

- Press the power button (6) to turn the fireplace/heater unit on and off. Press the power button (6) once to turn the unit on. Press again to turn the unit off.

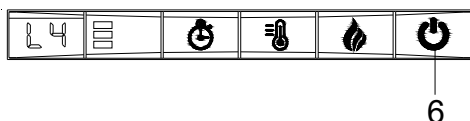

## 7 Using the Demo Mode

- **For Use in Retail Store**
- To turn Demo Mode on, press and hold the timer button (3) for 10 seconds until the display (1) shows "00". Demo Mode deactivates the heater and all front control panel buttons except the flame control button. To turn Demo Mode off, press and hold the timer button (3) for 10 seconds until the display (1) shows "L4". This fireplace is shipped with Demo Mode turned off for normal customer usage.

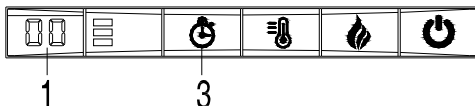

## Using the Remote Control

### 1 Installing the battery

For replacement batteries, use AAA batteries.

- Press down and slide back cover off the battery compartment.
- Insert two provided AAA batteries into the battery compartment making sure that the ends of the batteries with the negative (-) symbols are against the springs in the battery compartment.
- Replace the battery compartment cover, making sure it snaps into position.
- Turn the remote over and aim it towards the fireplace/heater unit.
- Press the power button on the upper left, and see if the flames on the fireplace/heater turn on or off.
- If nothing appears to happen, check to make sure the battery is installed correctly, and try again.

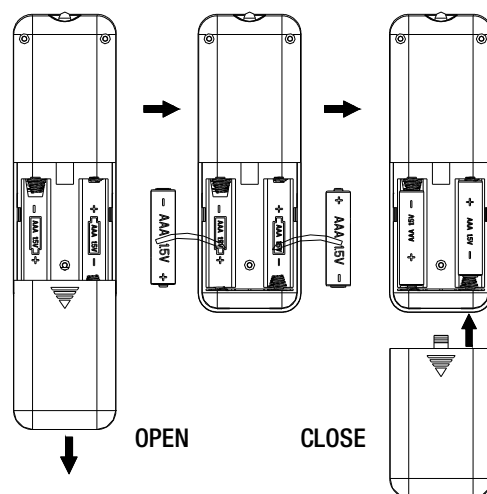

## Using the Remote Control (continued)

### 2 Battery Replacement



**NOTE:** Do not mix old and new batteries.  
Do not mix alkaline, standard (carbon zinc), or rechargeable (nicad, nimh, etc.) batteries.



**WARNING:** Do not ingest batteries.

1. Non-rechargeable batteries are not to be recharged.
2. Batteries are to be inserted with the correct polarity.
3. Exhausted batteries are to be removed from the product.
4. Always purchase the correct size and grade of battery most suitable for the intended use.
5. Replace all batteries of a set at the same time.
6. Clean the battery contacts and also those of the device prior to battery installation.
7. Remove batteries from equipment when not used for an extended period of time.



**NOTE:**  
Battery disposal  
Please always dispose of batteries  
at a suitable recycling point.

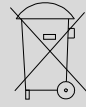
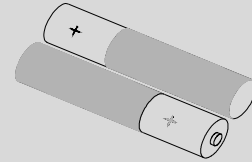

### 3 Using the remote control

- The operation of the remote control buttons work the same as the buttons on the front panel of the fireplace/heater. Review the operation section for more information on the functionality of these buttons.



**NOTE:** The remote control cannot lock/unlock the flame and heating function, and it cannot switch between Fahrenheit and Celsius.

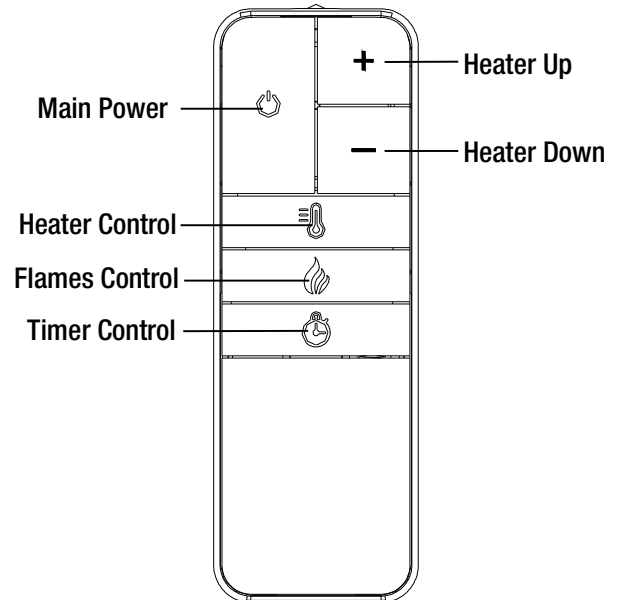



## Care and Maintenance

---



**WARNING:** Always disconnect from the power supply before cleaning the heater. First turn off the main power. Then remove the electrical plug from the wall outlet.



**WARNING:** Do not use this fireplace insert if any part of it has been under water. Immediately call a qualified service technician to inspect the firebox and replace any part of the electrical system which has been under water.

The blower motor and flame motor are pre-lubricated for a durable using time and need no further lubrication or maintenance. To remove any accumulation of dust or debris, the soft brush attachment of a vacuum cleaner should occasionally be used to clean the outlet grille of the fan heater.

- Use a soft, clean cloth that will not scratch the surface when dusting.
- Use a clean soft cloth dampened with warm water to clean the fireplace surface. DO NOT use household or abrasive cleaners, as these products may damage the surface.
- When cleaning the glass viewing screen use a non-abrasive damp cloth with liquid cleaner or soft soap if necessary; DO NOT use cleaning powders or any other substance with abrasives since these substances will scratch glass.
- Under no circumstances should this product be operated with a broken or chipped glass panel.
- Do not strike or slam the glass.
- In the event that your appliance is stained or otherwise damaged during use, we recommend that you call a professional to repair it.
- When not in use please unplug the cord from the outlet to prevent any damage or accidents.

# Troubleshooting

Problem	Solution
Cannot adjust the temperature.	<ul style="list-style-type: none"> <li>❑ To adjust temperature, turn on the Heater, then press the Heater button to enter Temperature Adjustment Mode. The LED display will start to flash, then press the Heater button repeatedly until you reach your desired temperature setting. (See "Using the Heater Control" in the OPERATION section of this Guide for more details).</li> </ul>
Cannot turn off the heater using the Heater Button.	<ul style="list-style-type: none"> <li>❑ Press the heater button repeatedly until "OF" is shown in the Control Panel display . This indicates the heater is "OFF". In this mode the flames remain on but the heater is not engaged. (See "Using the Heater Control" in the OPERATION section of this Guide for more details).</li> </ul>
Fireplace stopped heating. There are flames, but the heater automatically keeps shutting itself off after a few minutes.	<ul style="list-style-type: none"> <li>❑ Set fireplace to a higher temperature or "always on".</li> <li>❑ Turn on the Heater, then press the Heater button to enter Temperature Adjustment Mode. The LED display will start to flash, then press the Heater button repeatedly until you reach your desired temperature setting. (See "Using the Heater Control" in the OPERATION section of this Guide for more details).</li> <li>❑ NOTE: your heater thermostat default temperature setting is 82 degrees Fahrenheit. If your room temperature is above 82 degrees, your heater will shut itself off, unless you adjust your heater thermostat to "always on".</li> <li>❑ Note that temperature around fireplace may be a few degrees higher than other areas in the room.</li> </ul>
No heat, and no way to power off the unit. Only the Flame button works properly. The control panel display shows "00" when the Power, Timer, or Heater button is pressed.	<ul style="list-style-type: none"> <li>❑ Fireplace is in Demo Mode.</li> <li>❑ To deactivate Demo Mode, press and hold the Timer button for at least 10 seconds until the display shows "L4".</li> </ul>
Remote control is not working.	<ul style="list-style-type: none"> <li>❑ Change the remote batteries.</li> <li>❑ Operate remote transmitter at a slow measured pace. Press the remote control buttons with an even motion and gentle pressure.</li> <li>❑ Repeatedly pressing buttons in rapid succession may cause the transmitter to malfunction.</li> <li>❑ Stand closer to your fireplace.</li> <li>❑ Remove objects that may block your remote control's ability to communicate with your fireplace.</li> </ul>
No heat, and pressing the Heater button causes the logs to flash several times.	<ul style="list-style-type: none"> <li>❑ Your heater has been locked (disabled for child safety mode).</li> <li>❑ To unlock, turn on the main power, then press and hold the Heater button for at least 10 seconds, until you see the logs starting to flash several times. The heater will now be unlocked and can be turned ON using normal operation of the Heater button.</li> </ul>
The unit does not turn on.	<ul style="list-style-type: none"> <li>❑ Check that the unit is fully plugged into a standard 120V outlet.</li> <li>❑ Press the Power button on the control panel.</li> </ul>
Using the fireplace with the heater ON causes a trip in my power circuit.	<ul style="list-style-type: none"> <li>❑ Unplug other appliances from the same circuit and same outlet as the fireplace. Do not overload the circuit.</li> <li>❑ Connect the fireplace to a properly grounded outlets with thicker cord.</li> <li>❑ Replace with a qualified fuse-box with a heavy load.</li> </ul>
The display unit on the control panel shows error code "EE".	<ul style="list-style-type: none"> <li>❑ Your thermistor sensor is loose or cut off.</li> <li>❑ Do not return to store.</li> <li>❑ Please email us or call our Toll Free # for a replacement Insert.</li> </ul>
The Heater automatically shut off, and pressing the Heater button causes no actions. Other control buttons are working, but the control panel displays "88" and the function indicator is flashing quickly.	<ul style="list-style-type: none"> <li>❑ The fireplace shut itself off as a safety protocol to prevent overheating (it is in alarm mode).</li> <li>❑ Make sure that no objects are blocking the air vents on the front, top, or back of your fireplace.</li> <li>❑ To reset the fireplace, unplug the unit from the wall outlet for 5 minutes, and let it cool down. After 5 minutes plug the unit back into the wall outlet, and operate as normal.</li> </ul>



# HOME DECORATORS COLLECTION

Questions, problems, missing parts? Before returning to the store,  
call Home Decorators Collection Customer Service  
8 a.m. - 7 p.m., EST, Monday-Friday  
9 a.m. - 6 p.m., EST, Saturday

**1-800-986-3460**

**[HOMEDEPOT.COM/HOMEDECORATORS](https://www.homedepot.com/homedecorators)**

Retain this manual for future use.