

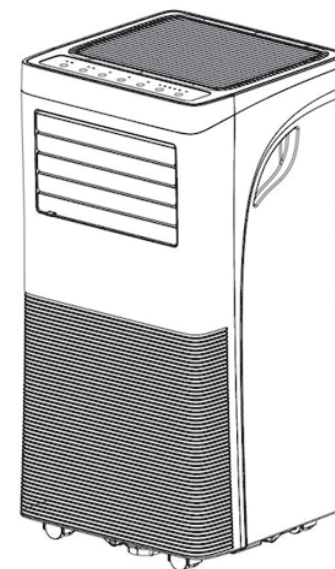

Please give us a chance to make it right and do better !

Contact our friendly customer service department for help first.
Replacements for missing or damaged parts will be shipped ASAP !

US office: Fontana **UK** office: Ipswich **AU** office: Truganina
DE office: Hamburg **FR** office: Saint Vigor d'Ymonville **PL** office: Gdańsk



Contact Us!

Do NOT return this item.

Contact our friendly customer service department for help first.



US:cs.us@costway.com
UK:cs.uk@costway.com
AU:cs.au@costway.com

USER'S MANUAL

Portable Air Conditioner FP10123US

THIS INSTRUCTION BOOKLET CONTAINS **IMPORTANT** SAFETY INFORMATION. PLEASE READ AND KEEP FOR FUTURE REFERENCE.



Before You Start

- ⚠ Please read all instructions carefully.
- ⚠ Retain instructions for future reference.
- ⚠ Separate and count all parts and hardware.
- ⚠ Read through each step carefully and follow the proper order.
- ⚠ We recommend that, where possible, all items are assembled near to the area in which they will be placed in use, to avoid moving the product unnecessarily once assembled.
- ⚠ Always place the product on a flat, steady and stable surface.
- ⚠ Keep all small parts and packaging materials for this product away from babies and children as they potentially pose a serious choking hazard.

1. BEFORE YOU BEGIN

1.1 PRODUCT DESCRIPTION

Our powerful portable air conditioners are great cooling solutions for single rooms, creating a comfortable atmosphere in your space. It also has ventilation and dehumidifying function for circulating air and removal of moisture. They're self-contained systems that do not require any permanent installation allowing you to move to the space in which it is most needed. They're commonly used in kitchen, temporary residence, computer rooms, garages, and many other places where installation of Air-conditioner Outdoor Unit is limited.

2. FOR YOUR SAFETY

Your safety is the most important thing we are concerned!

 WARNING	<p>Please read this manual carefully and fully understand before operating your appliance.</p>
--	--

2.1 OPERATIONAL PRECAUTIONS

WARNING- to reduce the risk of fire, electric shock or injury to persons or property:

- Please let the portable air conditioner stand upright for at least 24 hours before plugging in.
- If the supply cord is damaged, it must be replaced by the manufacturer, or similarly qualified persons in order to avoid a hazard.

- The appliance shall be disconnected from its power source during service.
- Always operate the unit from a power source of equal voltage, frequency and rating as indicated on the product identification plate.
- Always use a power outlet that is grounded.
- Unplug the power cord when cleaning or when not in use.
- Do not operate with wet hands. Prevent water from spilling onto the unit.
- Do not immerse or expose the unit to rain, moisture or any other liquid.
- Do not leave the unit running unattended. Do not tilt or turn over the unit.
- Do not unplug while the unit is operating.
- Do not unplug by pulling on the power cord.
- Do not use an extension cord or an adapter plug.
- Do not put objects on the unit.
- Do not climb or sit on the unit.
- Do not insert fingers or other objects into the air outlet.
- Do not touch the air inlet or the aluminum fins of the unit.
- Do not operate the unit if it is dropped, damaged or showing signs of product malfunction.
- Do not clean the appliance with any chemicals.
- Ensure the unit is far away from fire, inflammable, or explosive objects.

- The unit shall be installed in accordance with national wiring regulations.
- Do not use means to accelerate the defrosting process or to clean, other than those recommended by the manufacturer.
- The appliance shall be stored in a room without continuously operation sources (for example: open flames, an operating gas appliance or an operating electric heater).
- The appliance shall be stored so as to prevent from mechanical damage occurring.
- Do not piece or burn, even after use.
- Be aware that refrigerants may not contain an odour.
- Compliance with national gas regulations shall be observed.
- Keep any required ventilation openings clear of obstruction.
- The appliance shall be stored in a well-ventilated area where the room size corresponds to the room area as specified for operation.

If you don't understand something or need help, please contact the customer services.

3. PRODUCT OVERVIEW

3.1 PRODUCT DIAGRAM

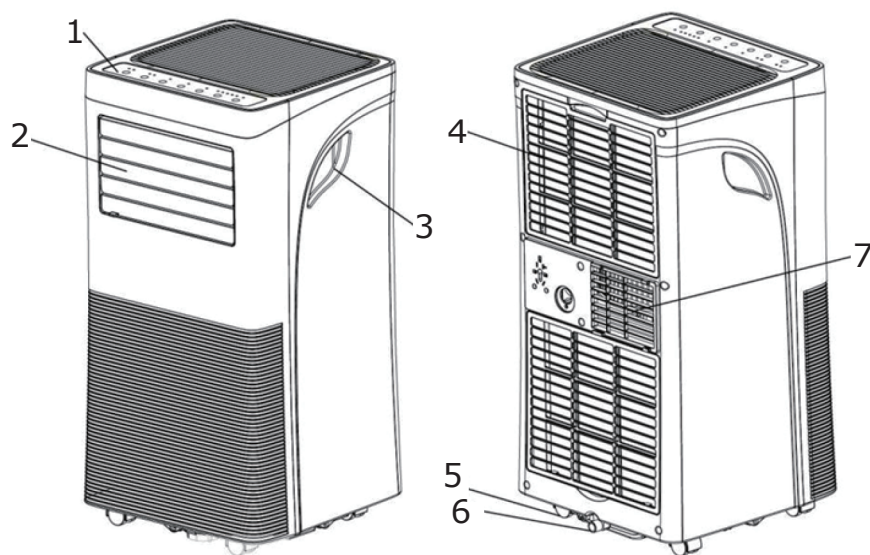

1	Control panel
2	Air outlet with adjustable louver
3	Handle
4	Air inlet with air filter
5	Caster
6	Drainage Hole
7	Air Exhaust

Note: The appearance is only for reference. Please see the real product for detailed information.

3.2 FEATURES

- ✓ High Capacity in a compact size with cooling, dehumidifying and fan function.
- ✓ Temperature setting and display
- ✓ LED Digital display
- ✓ Electronic control with built-in timer, sleep mode
- ✓ Self-evaporating system for better efficient
- ✓ Auto shut off when tank full
- ✓ Automatic restart in the event of power outage
- ✓ Auto defrosting function at low ambient temperatures
- ✓ Remote control
- ✓ 2-speed fan
- ✓ Casters for easy mobility

4. INSTALLATION

4.1 UNPACKING

- Unpack the carton and take the appliance and accessories out.
- Check the device after unpacking for any damage or scratches on it.

• Accessories:

- 1. Exhaust hose
- 2. Hose connector
- 3. Window kit adapter
- 4. Remote control

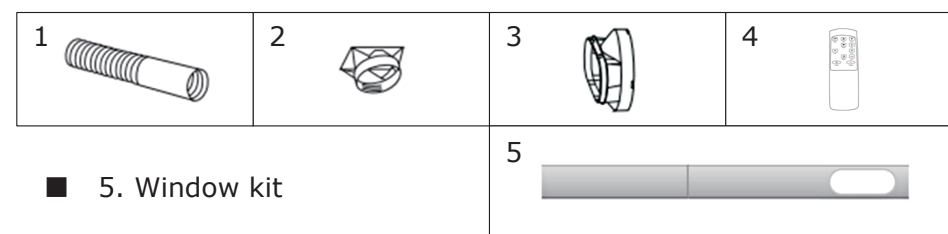

- 5. Window kit

4.2 Choose your location

- If tipped more than 45°, allow the unit to set upright for at least 24 hours before start up.
- Place the unit on a firm, level surface in an area with at least 50cm (20") of free space around it to allow for proper air circulation.
- Do not operate in close proximity to walls, curtains, or other objects that may block air inlet and outlet. Keep the air inlet and outlet free of obstacles.
- Never install the unit where it could be subject to:
 - ★ Heat sources such as radiators, heat registers, stoves or other products that produce heat.
 - ★ Direct sunlight
 - ★ Mechanical vibration or shock
 - ★ Excessive dust
 - ★ Lack of ventilation, such as cabinet or bookcase
 - ★ Uneven surface

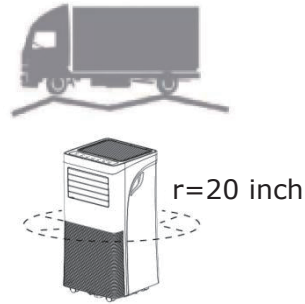

4.3 ATTACH THE EXHAUST HOSE

The air conditioner requires being vented outside so that the exhaust air can escape the room which coming from the appliance contains waste heat and moisture.

Do not replace or extend exhaust hose which will result in decreased efficiency, even worse shut down the unit due to low backpressure.

Step 1:

Connect the hose connector to one end of the exhaust hose.

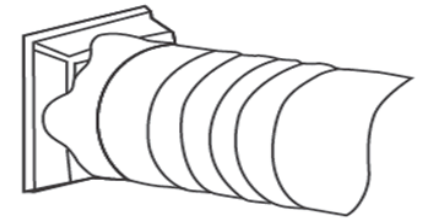

Step 2:

Connect the windows kit adapter to the other end of the exhaust hose.

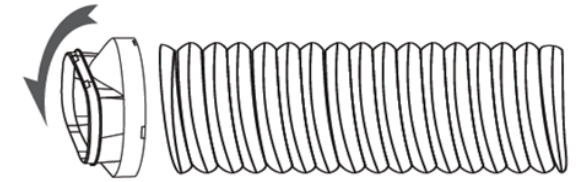

Step 3:

Extend the adjustable window kit to the length of your window. Connect the exhaust hose to the window kit.



Step 4:

Close your window to secure the kit in place. It needs to hold the windows kit firmly in place, secure the window kit with duct tape if required. It is recommended that the gap between the adapter and the sides of the window should be sealed off for maximum efficiency.

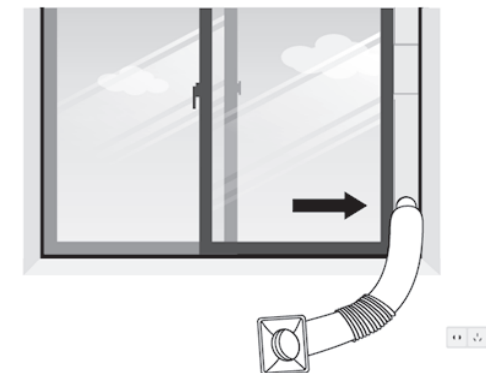

Step 5:

Attach the hose connector to the exhaust air outlet of unit.

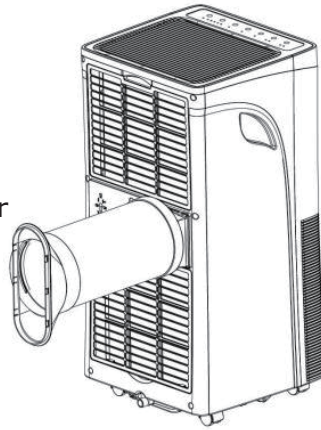
**Step 6:**

Adjust the length of the flexible exhaust hose, and avoid bends in the hose. Then place AC near an electrical outlet.

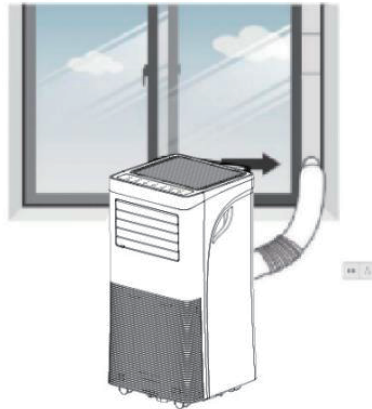
**Step 7:**

Adjust the louver at the air outlet, and then switch on the unit.

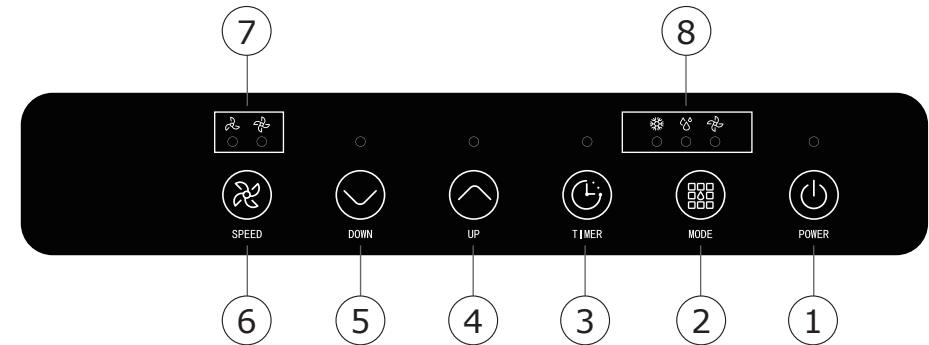
5. OPERATION**5.1 CONTROL PANEL AND DISPLAY**

1	POWER	Press to switch the machine on or off.
2	MODE	Press Mode button to switch the operation mode between fan, cooling, and dehumidifier.
3	TIMER	Set a time for the unit to automatically start or stop.
4	UP	Increase the desired temperature (60.8°F-89.6°F/16°C~32°C) or timer setting.
5	DOWN	Decrease the desired temperature or timer setting.
6	SPEED	Press to switch the fan speed between HIGH and LOW
7	FAN SPEED Indicator	Display high fan speed & low fan speed
8	MODE Indicator	The Mode Display between Cooling, Dehumidifying and fan.

5.2 REMOTE CONTROL

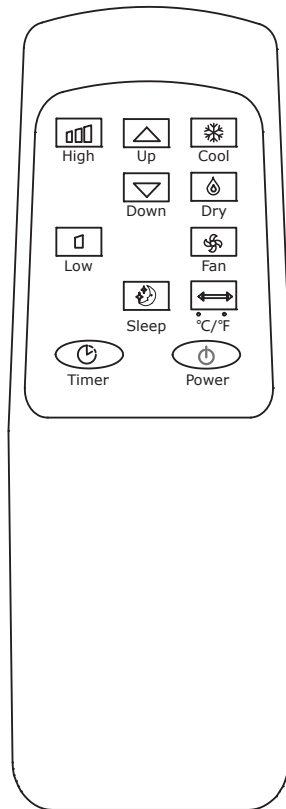

5.3 SETTINGS

5.3.1 Start-up and Shutdown

- ⇒ Press POWER to turn the unit on.
The unit runs in in FAN as default.
- ⇒ Press MODE button to select the desired operation mode.
- ⇒ Press POWER again to turn off the power.

5.3.2 Operation mode

The unit has four operation modes: Cool, dry, fan, sleep.

A. Cooling your room

Select the cool mode to lower the temperature in your room.

- ⇒ Press MODE button repeatedly until the LED of COOL operation lights up.
- ⇒ Press Up/Down button to adjust the temperature which is displayed on the screen. The temperature can be set between 60.8°F (16°C) and 89.6°F (32°C).
- ⇒ Press SPEED button repeatedly until the desired fan speed indicator lights up.

To control the direction of the air flow horizontally, please adjust the inner louver by hand.

Note: The air conditioner stops if the room temperature is lower than selected temperature.

B. Ventilating your room

- ⇒ Press MODE button repeatedly until the LED of FAN operation lights up.
- In ventilation mode the room air is circulated, but not cooled.
- ⇒ Press SPEED button repeatedly to select the fan speed as desired.

C. Drying your room

- ⇒ Press MODE button on the control panel or remote control, the LED of DRY operation lights up. The fan speed is unable to select. User should connect the hose to the drain outlet at the bottom of the unit.

Note: In this mode, the fan speed switches over to low speed and cannot be selected.

D. Sleep mode (this function can only be used with a remote control)

The sleep mode can be activated when in cool mode.

After 1 hour the preset temperature is increased by 33.8°F(1°C), after another hour the preset temperature will again be increased by 33.8°F(1°C).

5.3.3 TIMER SETTING (1hour-24hours) :

The timer has two ways of operation:

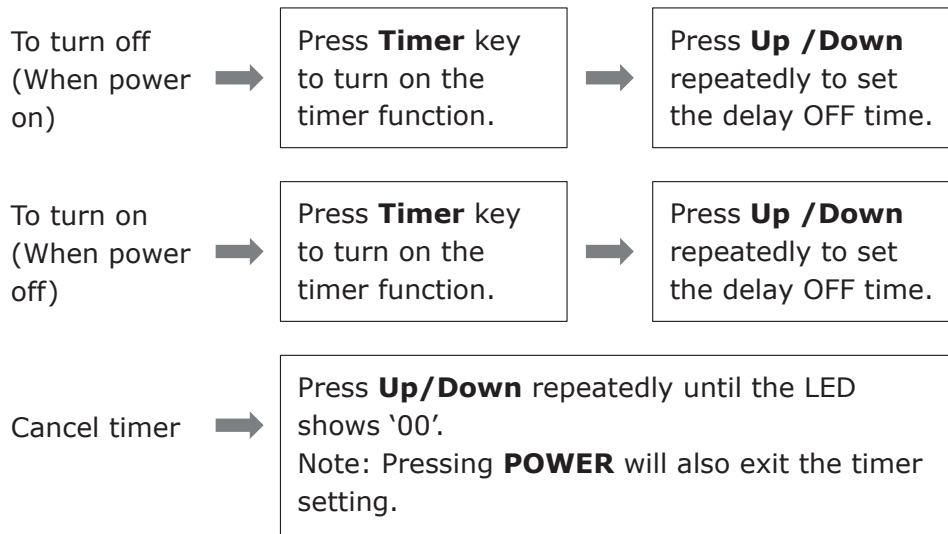

5.3.4 Automatic Defrost

At low room temperatures, frost may build up at the evaporator during operation. The unit will automatically start defrosting and the **POWER** LED blinking. The defrost control sequence is as follows:

A. When the unit operates in the cooling operation, drying operation, the ambient temperature sensor senses the evaporator coil temperature is below 30.2°F(-1°C), after the compressor will stop operating for 10 minutes or the coil temperature up to 44.6°F(7°C), the unit restart to cool operating mode.

5.3.5 Overload Protection

In the event of a power loss, to protect the compressor there is a 3-minute delay until the compressor restarting.

5.4 DRAINAGE

Self- evaporating system

The self-evaporating system uses the collected water to cool the condenser coils for better efficient performance. It is no need to empty the drainage tank in cooling operation except in drying operation and high humidity conditions. The condensate water evaporates at the condenser and evacuated through the exhaust hose.

For continuous operation or unattended operating in drying operation, please connect the attached drain hose to the unit. Condensate water can be automatically flow into a bucket or drain by gravity.

- Switch off the unit before operating.
- Remove the plug of the water outlet opening, and keep it in safe area.
- Securely and properly connect the drain hose and make sure it is not kinked and clear of obstruction.
- Place the outlet of hose over a drain or bucket and ensure that water could freely flow out of the unit.
- Do not submerge the end of hose into water; otherwise it can cause "Air Lock" in the hose.

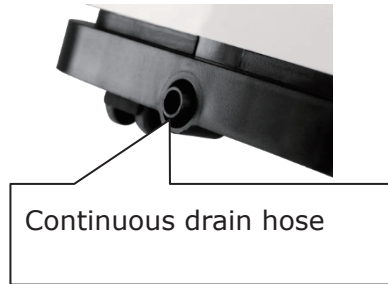
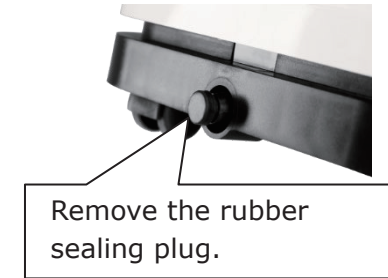

To avoid water spillage:

- As the negative pressure of condensate drain pan is large, tilt the drain hose downward toward the floor. It is appropriate that the degree of inclination should exceed 20 degrees.
- Straighten the hose to avoid a trap existing in the hose.

6. CLEANING AND CARE

6.1 CLEANING THE AIR FILTER (every two weeks)

Dust collects on the filter and restricts the airflow. The restricted airflow reduces the efficiency of the system and if it becomes blocked it can cause damage to the unit.

The air filter requires regular cleaning. The air filter is removable for easy cleaning. Do not operate the unit without an air filter, or the evaporator may be contaminated.

1. Press POWER button to switch off the unit and unplug the power cord.
2. Remove the filter mesh from the unit.
3. Use a vacuum cleaner to suck dust from the filter.
4. Turn the filter over and rinse the air filter under running water. Let the water run through the filter in the opposite direction of air flow. Set aside and allow the filter to air dry completely before reinstalling.

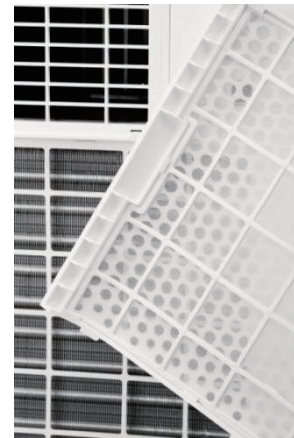

Pic 1. Switch off the unit and remove the two air filters.

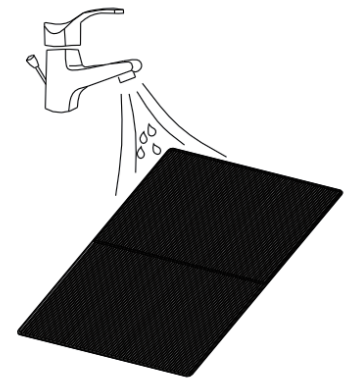

Pic 2. Rinse the air filter under running water.

Warning!!!

Do not touch the evaporator surface with bare hands, or it could cause injury of your fingers.

6.2 CLEANING UP OF REFRIGERANT

General Measures:

1. Gas/vapor heavier than air. It may be accumulated in confined spaces, particularly at or below ground level.
2. Eliminate every possible source of ignition.
3. Use appropriate personal protection equipment (PPE).
4. Evacuate unnecessary personnel, isolate, and ventilate area.
5. Do not get in eyes, on skin, or on clothing. Do not breathe vapors or gas.
6. Prevent entry to sewers and public waters.
7. Stop the source of the release, if safe to do so. Consider the use of water spray to disperse vapors.
8. Isolate the area until gas has dispersed. Ventilate and gas test area before entering. Contact competent authorities after a spill.

7. TROUBLESHOOTING

Symptom	Inspection	Solution
The unit is not operating.	✓ Check the power connection in securely.	■ Insert the power cord securely into the wall outlet.
	✓ Check if the water level indicator lights up?	■ Empty the drain pan by removing the rubber plug.
	✓ Check the room temperature.	■ The range of operating temperature is 41°F-95°F(5°C-35°C).

The unit works with reduced capacity.	✓ Check the air filter for dirt.	■ Clean the air filter as necessary.
	✓ Check if the air duct is blocked.	■ To clear the obstacle.
	✓ Check if the room door or window is open.	■ Keep the door and windows closed.
	✓ Check if the desired operating mode is selected and the temperature is properly set.	■ Set the mode and temperature at proper set-point according the manual.
	✓ The exhaust hose is detached.	■ Make sure the exhaust hose is securely attached.
Water Leakage	✓ Overflow while moving the unit.	■ Empty the water tank before transport.
	✓ Check if the drain hose is kinked or bent.	■ Straighten the hose to avoid a trap existing.
Excessive Noise	✓ Check if there are any loose or vibrating parts.	■ Secure and tighten the parts.
	✓ Check if there are any loose or vibrating parts.	■ Secure and tighten the parts.
	✓ Noise sounds like water flowing.	■ Noise comes from flowing refrigerant. This is normal.

Error Codes	E0	√ Communication faults between main PCB and display PCB.	■ Check the wire harness of the display PCB for damage.
	E1	√ Ambient temperature sensor failure.	■ Check connection or replace it. To clean or replace the temperature sensor.
	E2	√ Coil temperature sensor failure.	■ Check connection or replace it. To clean or replace the temperature sensor.
	Ft	√ Condensate water high level alarm.	■ Empty the drain pan by removing the rubber plug.

8. DECOMMISSIONING

8.1 STORAGE

Long-Term Storage - If you will not be using the unit for an extended period of time (more than a few weeks) it is best to clean the unit and dry it out completely. Please store the unit as per the following steps:

1. Unplug the unit and remove exhaust hose and window kit, store with the unit.
2. Drain the remaining water from the unit.
3. Clean the filter and let the filter dry completely in a shaded area.
4. Re-install the filter at its position.
5. The unit must be kept in upright position when in storage.
6. Preserving the machine in ventilating, dry, non- corrosive gas and safe place indoors.

ATTENTION:

The evaporator inside the machine has to be dried out before the unit is packed to avoid component damage and molds. Unplug the unit and place it in a dry open area for days to dry it out. Another way to dry the unit is turn on the machine, adjust it to low-wind ventilation mode, and maintain this state until the drainage pipe becomes dry, so as to keep the inside of the body in a dry state and prevent it from mildewing.

8.2 DISPOSAL



WARNING!!!

Releasing refrigerant into atmosphere is strictly forbidden!

Do not dispose of electrical appliances as unsorted municipal waste, use separate collection facilities. Contact your local government for information regarding the collection systems available. If electrical appliances are disposed of in landfill or dumps, hazardous substances can leak into the groundwater and get into the food chain, damaging your health and well-being.

