

# ASSEMBLY INSTRUCTIONS

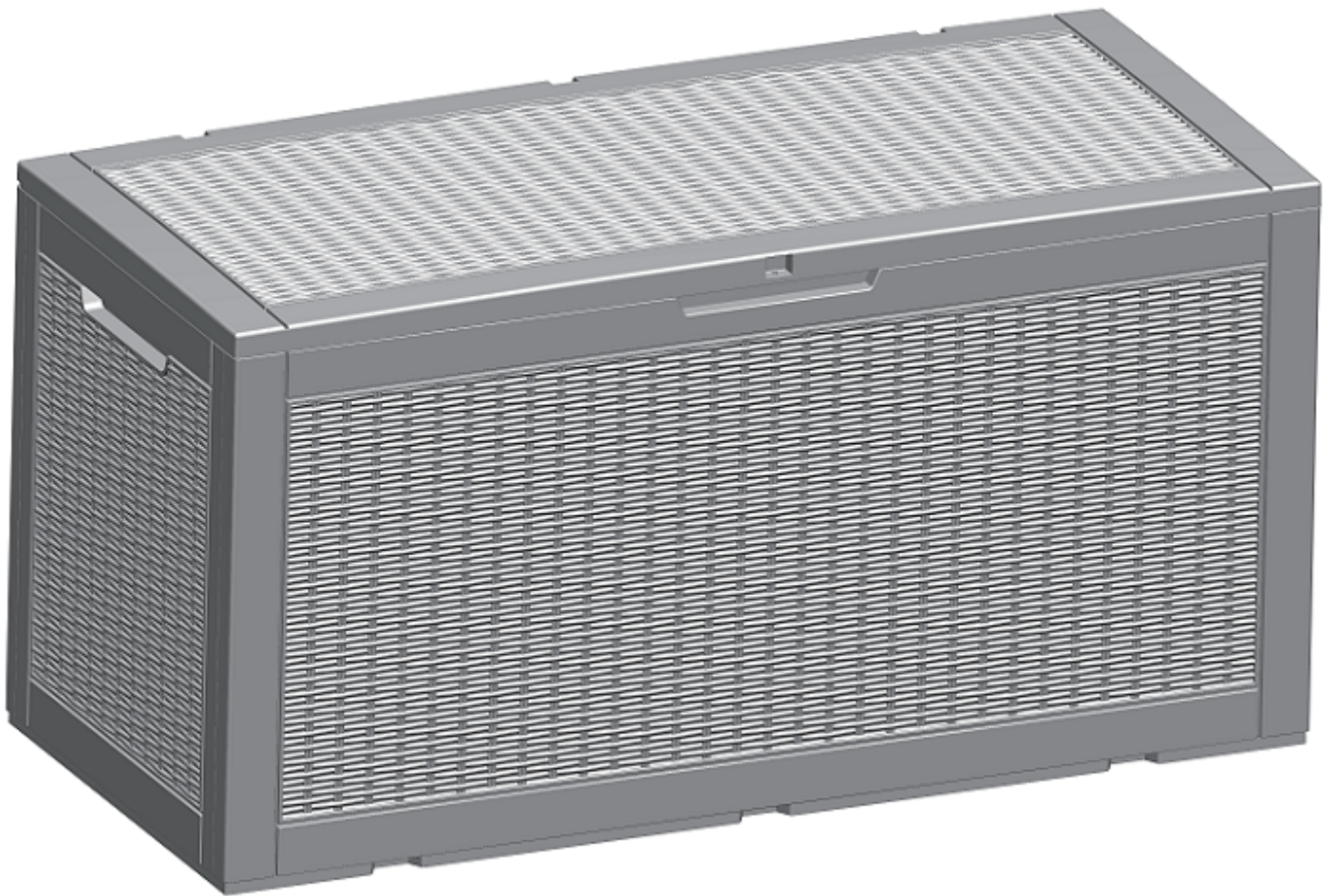



---

- 1-Piece  
Storage Box

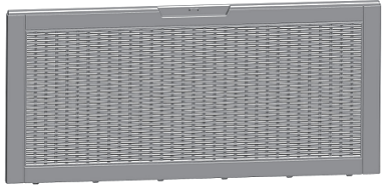
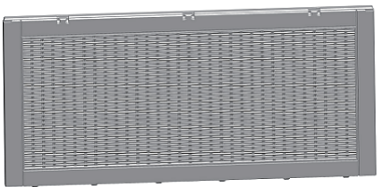

# Parts

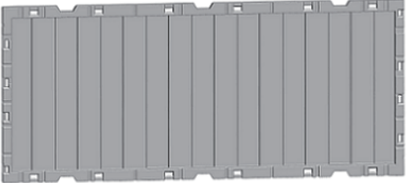
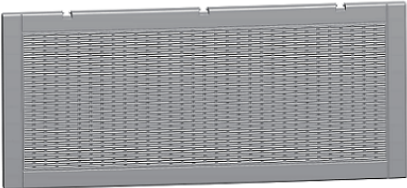
Check and make sure you get the components on the list, contact us for any missing

<b>A</b>	 Front box piece	1PC	<b>B</b>	 Rear box piece	1PC
<b>C</b>	 Side box piece	2PCS	<b>D</b>	 Bottom plate	1PC
<b>E</b>	 cover	1PC	<b>F</b>	 Self-tapping screws	8PCS
<b>G</b>	 Gas rod	2PCS			

# Assembly steps

## Storage Box Assembly steps

1

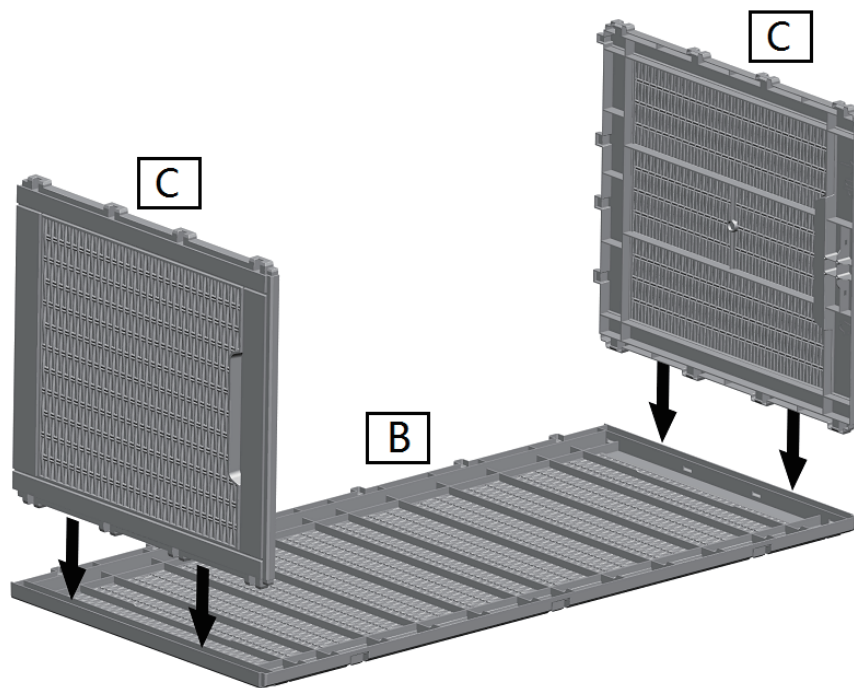

2

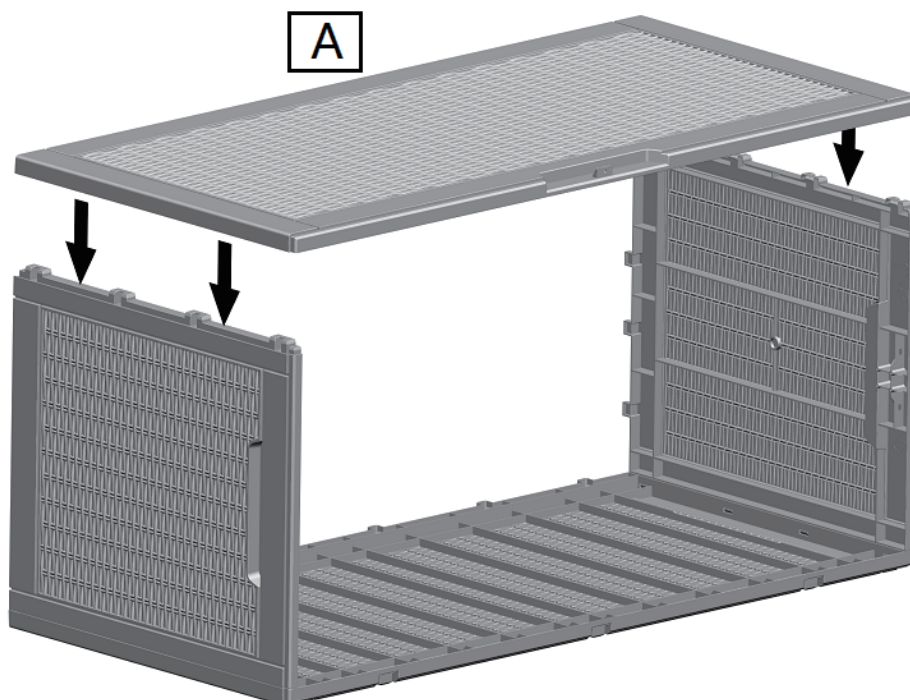

# Assembly steps

3

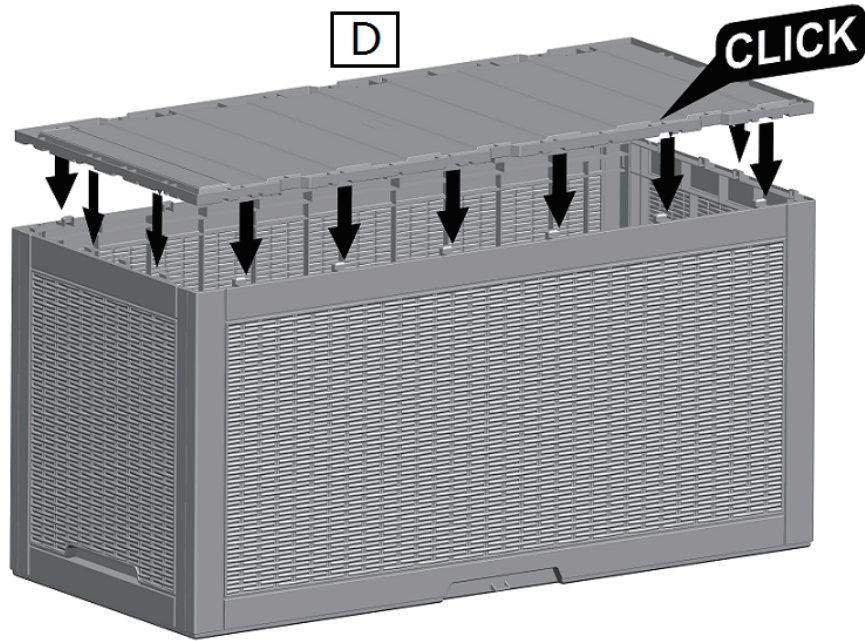

4

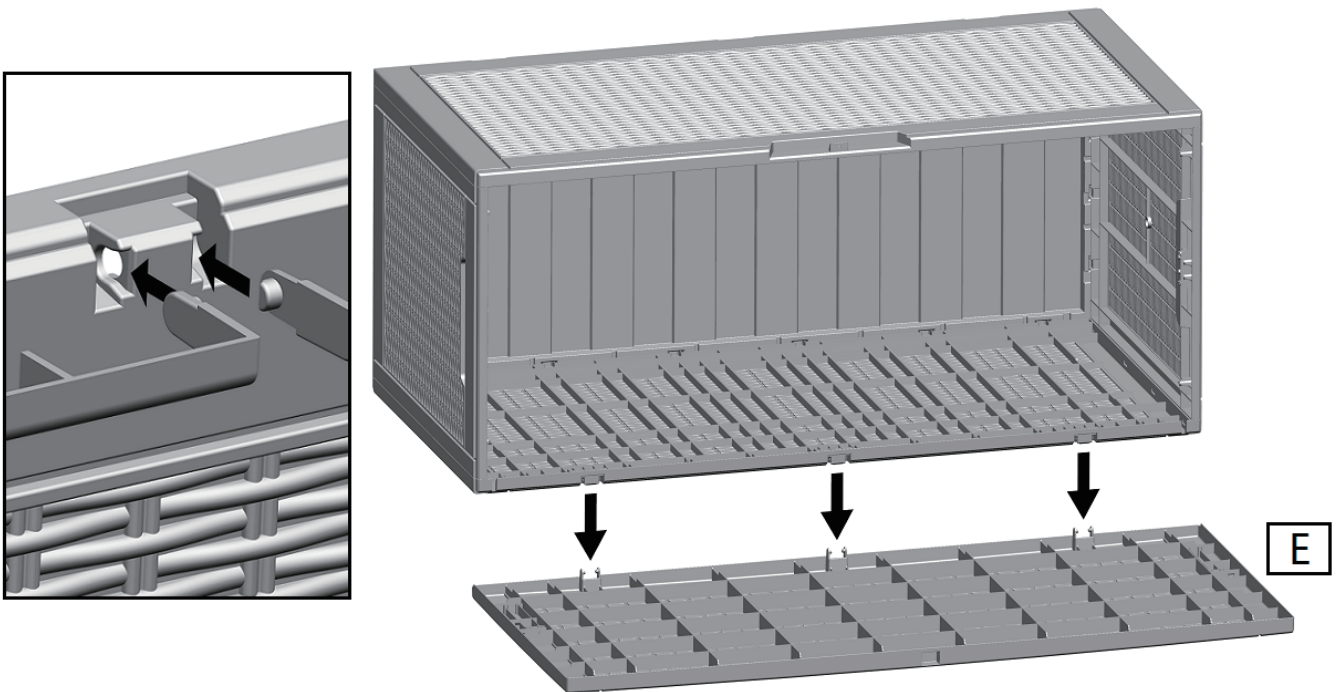

# Assembly steps

5

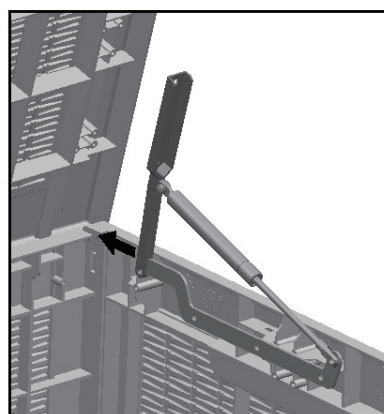
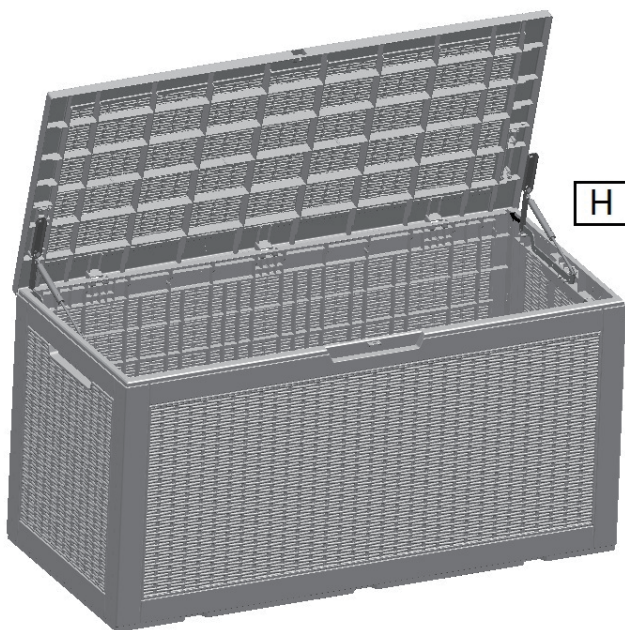

6

