

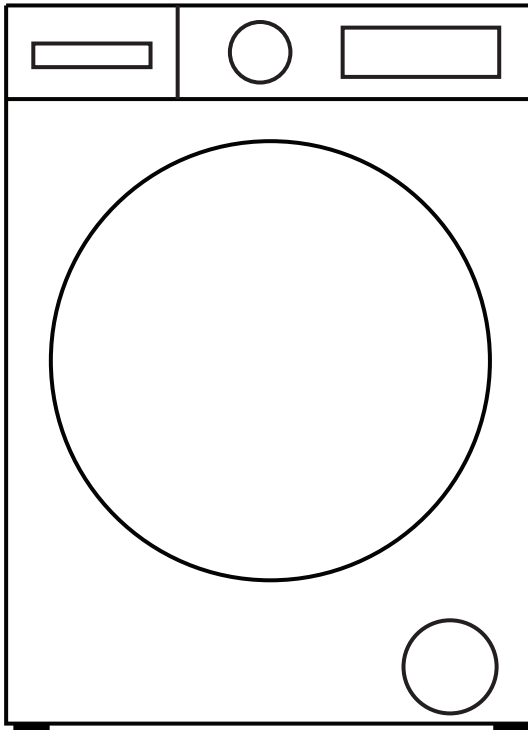

High Efficiency Washer

Model - CW 2240 W/B/T



OWNER'S MANUAL

Please read the instructions carefully and keep for future reference. Information may be updated from time to time so please refer to the manual online for the latest version of the manual.

WARRANTY INFORMATION

Your appliance is protected by this warranty under normal, personal, family or household use for 2 Year Parts & Labor and limited commercial use (90 days) in USA and Canada.

WARRANTY

Conserv Appliances undertakes to the consumer/owner to repair or, at our option, to replace any part of this product which proves to be defective in workmanship or material under normal personal, family or household use in USA and Canada, for a period of two years parts & labor from the date of original purchase. For commercial use, the product is warranted for a period of 90 days.

During this period, we will provide all labor and parts necessary to correct such defect, free of charge, if the appliance has been installed and operated in accordance with the written instructions provided with the appliance. Ready access to the appliance, for service, is the responsibility of the consumer/owner. If unit installed in closet or cabinet, it should be removed for access by service technician. If this cannot be done, then there will be extra charge.

We may require return of products or parts to our warranty department for which the shipping charges are to be incurred by the consumer. If a return or replacement is required, allow 3-4 weeks to process. If unit is located more than 25 miles there will be a trip charge. If unit is in remote area more than 75 miles, customer will need to take the product to the technician's workshop. Replacement unit will be delivered with curb side delivery only. If Unit is installed in a 5th wheel RV, in a location behind the axle it won't be covered under warranty.

All repairs or replacements are warranted only for the remainder of the original warranty period. Charges may incur if warranty coverage is not applicable. Service would be provided from Monday to Friday between normal business hours.

GENERAL

Since it is the responsibility of the consumer/owner to establish the warranty period by verifying the original purchase date, Conserv Appliances recommends that a receipt, delivery slip or some other appropriate payment record be kept for that purpose. This warranty gives you specific legal rights, and you may also have other rights which vary from State to State.

You can register your warranty by either of following methods:

1. Scan the QR Code
2. Online at: ApplianceDesk.com/Warranty

QR Code



1. Open Smart Phone
2. Open Camera
3. Scan QR Code
4. Click the Link

WARRANTY SERVICE

This warranty is given by:

Conserv Appliances
10222 Georgibelle Drive, Suite 200,
Houston, TX 77043-5249

QUESTIONS / SERVICE

Phone/Text: 1-800-776-3538

Email: Service@ApplianceDesk.com

Web: www.ApplianceDesk.com

Exclusions

In no event shall Conserv Appliances be liable for incidental or consequential damages or for damages resulting from external causes such as abuse, operation misuse, neglect, alterations, normal wear and tear, incorrect voltage or acts of God. This warranty does not cover service calls which involve defective workmanship, damage due to other products while combined use with this product or materials covered by this warranty. Accordingly, diagnosis and repair costs for a service call which involves defective workmanship or materials will be the responsibility of the consumer-owner.

Most work is covered. The defining factor is has the appliance malfunctioned (Conserv Appliances is responsible) or has the customer omitted or done something to cause malfunction (customer is responsible).

THE FOLLOWING WORK ARE NOT COVERED UNDER WARRANTY:

Installation

1. Non-removal of shipping bolts, causing vibration, resulting in internal damage.
2. Non-adjustment of feet to level machine, causing vibration, resulting in internal damage.
3. Not conforming to minimum space requirements for built-in installation, resulting in damage to internal components.
4. Installation in a corrosive environment.
5. Incorrect water pressure i.e below 7.25 psi or above 145 psi
6. Incorrect water inlet hose installation (use only factory supplied hoses with metric threads on the L shaped side to fit water valve)

Maintenance

1. Non-cleaning of coin trap for debris, causing the unit to not drain out water and resulting in drain pump malfunction.
2. Improper maintenance (such as, but not limited to, scale build-up, freeze damage, or vent blockage).

Damage

1. Breakage of cosmetic parts e.g., door handle, knob.

Other

1. Accident, abuse or misuse.
2. Using solvents to clean the machine or wash clothes, causing damage.
3. Misapplication of this product e.g., use in a non household/commercial environment.
4. Any other cause not due to defects in materials or workmanship.
5. Problems or damage due to fires, flooding, electrical surges, freezing or any acts of God.
6. Any damage caused by poor water quality.
7. Operating the appliance with anything other than potable water at all times.
8. Force majeure.

Warranty Limitations

1. If a unit is located more than 25 miles away, there will be a trip charge.
2. If a unit is in a remote area more than 75 miles away, the machine should be taken to the technician's workshop.
3. If the unit is installed in a 5th wheel RV, in a location behind the axle, it will not be covered under warranty.
4. All repairs or replacements are warranted only for the remainder of the original warranty period.
5. If a return or replacement is required, allow 3-4 weeks to process.
6. Replacement units will be delivered with curbside delivery only.
7. We may require the return of products or parts to our warranty department for which the shipping charges are to be pre-paid by the consumer / owner.
8. Charges may be incurred if warranty coverage is not applicable.
9. Service would be provided from Monday to Friday between normal business hours.

GENERAL

Since it is the responsibility of the consumer / owner to establish the warranty period by verifying the original purchase date, Conserv Appliances recommends that a receipt, delivery slip or some other appropriate payment record be kept for that purpose. This warranty gives you specific legal rights, and you may also have other rights which vary from state to state.

All rights reserved. Manual subject to change without notice.

 **WARNING:** This product can expose you to chemicals including Diisononyl Phthalate (DINP) which is known to the State of California to cause cancer.

For more information go to www.P65Warnings.ca.gov



Table of Contents

Safety	1
Installation	5
Electrical Connection	7
Grounding Instructions	7
Water Inlet Hose Connection	8
Water Discharge Connection	9
Operation	10
Control Panel	11
Detergent Drawer and Compartments	11
Program Dial	12
Wash Programs Table	13
Display Panel	14
Maintenance	17
Troubleshooting	21
Error Codes	23
Technical Specifications	23

SAFETY

Your safety and the safety of others are very important.

Please read and follow the important safety warnings in this manual and on your appliance.

 DANGER	Danger indicates a hazardous situation that, if not avoided, will result in death or serious injury.
 WARNING	Warning indicates a hazardous situation that, if not avoided, could result in death or serious injury.
 CAUTION	Caution indicates a hazardous situation that, if not avoided, could result in minor or moderate injury.

To reduce the risk of fire, electric shock, or injury to persons when using your appliance, always follow basic precautions.

WARNING Risk of Fire

- Do not wash items that have been previously cleaned in, washed in, soaked in, or spotted with gasoline, dry-cleaning solvents, or other flammable or explosive substances, as they give off vapors that could ignite or explode.
- Do not add gasoline, dry-cleaning solvents, or other flammable or explosive substances to the wash water. These substances give off vapors that could ignite or explode.
- Under certain conditions, hydrogen gas may be produced in a hot-water system that has not been used for 2 weeks or more. **HYDROGEN GAS IS EXPLOSIVE.** If the hot-water system has not been used for such a period, before using the appliance, turn on all hot-water faucets and let the water flow from each faucet for several minutes. This will release any accumulated hydrogen gas. As the gas is flammable, do not smoke or use an open flame during this time.
- Do not store flammable liquids near the appliance.
- The sulfur content of paint removers may cause corrosion. Never use paint removing materials in the appliance.
- Never use products that contain solvents in the appliance.

- Please ensure that items loaded into your appliance do not have plastic, metallic, or sharp objects such as pins, keys, or coins.
- Do not tamper with controls.
- Do not repair or replace any part of the appliance or attempt any servicing unless specifically recommended in the manual or in published user-repair instructions that you understand and have the skills to carry out.
- To reduce the risk of electric shock, disconnect this appliance from the power supply before attempting any maintenance. Turning the controls to the OFF position does not disconnect this appliance from the power supply.

 WARNING Risk of Burns

Do not touch the drain hose or any discharged water while your appliance is running. The high temperatures pose a burn risk.

Risk of Injury or Death from Electrical Current

- Do not connect your appliance to the mains electricity supply using an extension cord.
- Do not insert a damaged plug into a socket.
- Never remove the plug from the socket by pulling the cord. Always hold the plug.
- Never touch the power cord/plug with wet hands as this could cause a short circuit or electric shock.
- Do not touch your appliance if your hands or feet are wet.
- A damaged power cord/plug can cause fire or give you an electric shock. A damaged cord or plug must be replaced by a qualified technician.
- Connect the appliance to a dedicated circuit.

Risk of Flooding

- Check the speed of water flow before placing the drain hose in a sink.
- Secure the hose to prevent it from slipping. Water flow may dislodge the hose if it is not properly secured.
- Ensure the plug in your sink does not block the drain.

Risk of Falling and Injury

- Do not climb on your appliance.
- Do not reach into the appliance if the drum is rotating.
- Ensure hoses and cables are secured and do not present a tripping hazard.
- Do not turn your appliance upside down or on its side.
- Do not lift your appliance using the door or detergent drawer.
- The appliance must be carried by at least 2 people.

Child Safety

- The appliance is not intended for use by people (including children) with reduced physical, sensory or mental capabilities, or lack of experience and knowledge unless they have been given supervision or instruction concerning use of the appliance by a person responsible for their safety.
- Children of less than 3 years should be kept away unless continuously supervised.
- Do not leave children unattended near the appliance. Children might lock themselves in the appliance resulting in risk of death.
- Children should not play with the appliance.
- Cleaning and maintenance should not be done by children.
- Do not allow children to touch the glass door during operation. The surface becomes extremely hot and may cause damage to skin.
- Poisoning and irritation may occur if detergent and cleaning materials are consumed or come into contact with the skin and eyes. Keep cleaning materials out of the reach of children.
- Keep packaging material away from children. The packaging of the appliance could be hazardous to children. Do not allow children to play with the packaging or small parts from the appliance.
- Keep the packaging materials in a place where children cannot reach them or dispose of them appropriately.
- Before the appliance is removed from service or discarded, remove the door to prevent child entrapment.

Safe disposal

Dispose off this appliance in accordance with local regulations.

Installation

Please check the packaging of the washer and the outer surface of the washer once the packaging has been removed. Do not operate the washer if it appears damaged or if the packaging has been opened.

Your washer must only be installed by an authorized service agent.

Before installing the washer, remove the shipping bolts.

1. Remove the 4 shipping bolts and rubber spacers from the back of the washer. If the bolts are not removed, they may cause heavy vibration, noise and malfunction of the washer and void the warranty.
2. Loosen the shipping bolts by turning them counterclockwise with a wrench.
3. Remove the shipping bolts by pulling them straight out.
4. Fit the plastic blanking caps supplied in the accessories bag into the gaps left by the removal of the shipping bolts. Store the shipping bolts for future use.

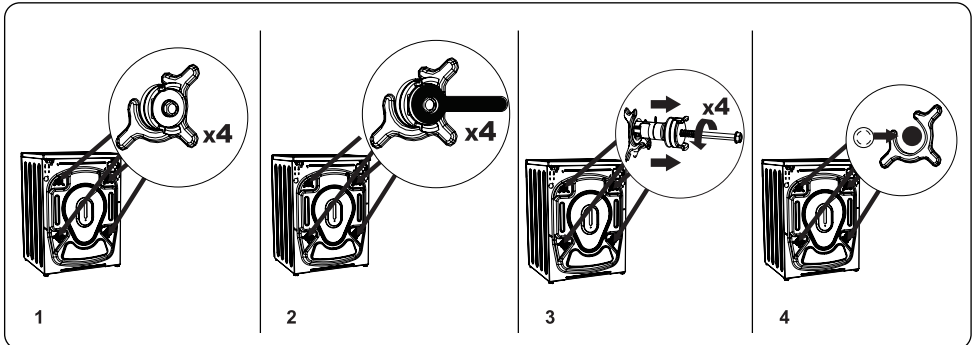

Placement

- The necessary ambient temperature for operation of your washer is 59°F - 77°F. If the temperature is below 32°F, hoses may split or the electronic module may not operate correctly.
- Do not install or store this washer where it will be exposed to the weather or outdoors.
- Install your washer in a location that can be fully ventilated and preferably has constant air circulation.
- Do not install the washer on a carpet or surfaces that would prevent the ventilation of its base.
- Ensure that the door of your washer is not restricted and can be opened fully.
- To ensure silent and vibration-free operation of the washer place the washer on a flat, smooth and firm surface.

Leveling

- Level your washer using the adjustable feet. Never insert cardboard, wood or other similar materials under the washer to level it.
- To increase the height of the washer, turn the feet clockwise. To decrease the height of the washer, turn the feet counterclockwise.
- Once the washer is level, tighten the locking nuts by turning them clockwise.

Electrical Connection

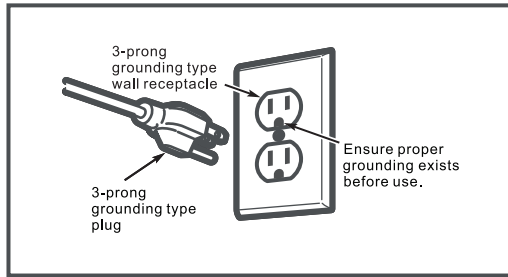

- The washer requires a 110 -120V / 60Hz mains supply.
- The mains cord of the washer is equipped with a grounded plug. This plug should always be inserted to a grounded outlet of minimum 15 amps.
- If connected to a circuit protected by fuses, use time-delay fuses with this washer.
- If you do not have a suitable socket and fuse conforming with this, please ensure the work is carried out by a qualified electrician.

Grounding Instructions

This washer must be grounded. In the event of malfunction or breakdown, grounding will reduce the risk of electric shock by providing a path of least resistance for electric current. This washer is equipped with a cord having an equipment-grounding conductor and a grounding plug. The plug must be plugged into an appropriate outlet that is properly installed and grounded in accordance with all local codes and ordinances.

⚠️ WARNING Improper connection of the equipment-grounding conductor can result in a risk of electric shock. Check with a qualified electrician or service technician if you are in doubt as to whether the washer is properly grounded.

Do not modify the plug provided with the washer. If it does not fit the outlet, ensure that the correct outlet is installed by a qualified electrician.

Water Inlet Hose Connection

Use only the water inlet hose provided with your washer when making water inlet connections to your washer. Never use old, used or damaged water inlet hoses.

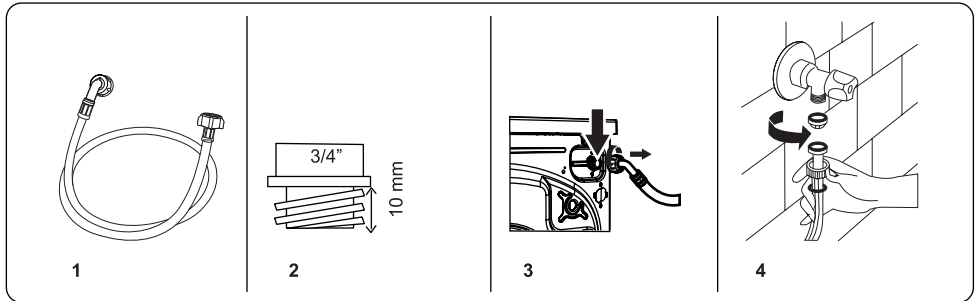

- Your washer has hot and cold water inlet connections. The red capped hose should be connected to the hot water inlet.
- To prevent water leaks at the joints, nuts are supplied with the hose. Fit these nuts to the end(s) of the water inlet hose that connect to the water supply.
- Connect the water inlet hoses to a 3/4" threaded tap.
- Connect the white capped end of the water inlet hose to the white water inlet valve on the rear side of the washer and the red capped end of the hose to the red water inlet valve (if applicable).
- Hand tighten the connections. If in any doubt, consult a qualified plumber.
- Water flow with pressure of 0.1-1 Mpa will allow your washer to operate at optimum efficiency. Pressure of 0.1 Mpa means that more than 2 gallons (8 liters) of water per minute will flow through a fully opened tap.
- Once you have made all of the connections, carefully turn the water supply on and check for leaks.
- Ensure that the new water inlet hoses are not trapped, kinked, twisted, folded or crushed.
- If the washer has a hot water inlet connection, the temperature of the hot water supply should not be higher than 158°F.

Note: Some water may be left in your washer as a result of quality checks during production. This will not affect the operation of your washer.

Water Discharge Connection

- Connect the water drain hose to a standpipe or to the outlet elbow of a household sink.
- Ensure that the drain hose is not bent, buckled, crushed or extended.
- The drain hose must be installed at a minimum height of 24 inches and maximum height of 40 inches from the ground.
- Do not extend the drain hose.
- Do not put the drain hose into a container, bucket or bathtub.

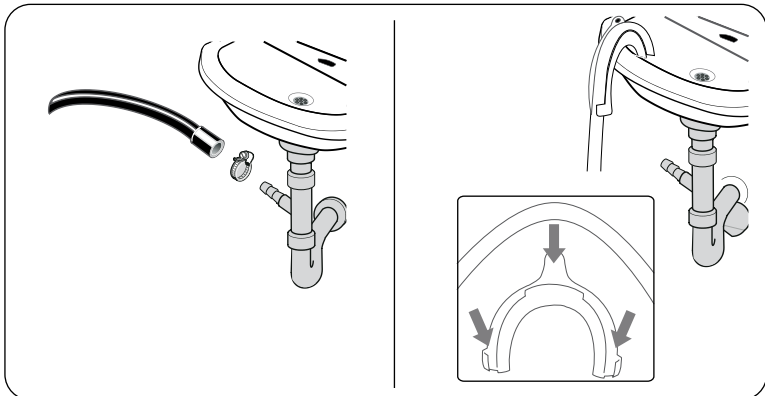
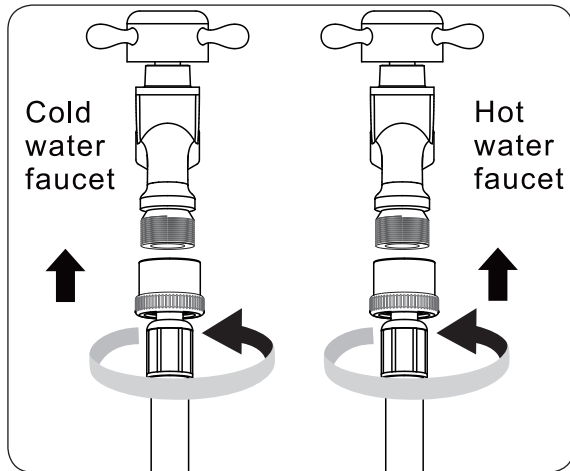

Operation

WARNING - To reduce the risk of fire, electric shock, or injury to persons, read **IMPORTANT SAFETY INSTRUCTIONS** before operating this washer.

Ensure the Washer is plugged in correctly and the water supply is turned on.

Ensure that children and pets have not climbed into the washer and keep them away from the washer when it is in use.

Preparation

- Follow the instructions given on the care labels on the clothing.
- Separate your laundry according to type (cotton, synthetic, sensitive, wool etc.), washing temperature and soil level.
- Never wash colored and white clothing together. Dark clothing may contain excess dye and should be washed separately several times.
- Please ensure that items loaded into your washer do not have objects such as lighters, keys, coins, etc. Any malfunctions due to foreign materials damaging your washer are not covered by the warranty.
- Close zips and fasten any hooks and eyes.
- Reverse items such as pants, t-shirts and sweat shirts.
- Wash small items in a net bag.
- Load each item of laundry separately.
- Do not overload the washer. You should be able to comfortably place your hand above the loaded laundry, ensuring there is enough space for the clothes to be washed properly.
- Check that no items of laundry are trapped between the rubber seal and the door.
- Gently push the door until it clicks shut. Ensure the door is fully closed, otherwise the program will not start.

Never force the door open or open the detergent drawer while the washer is in operation.

Control Panel

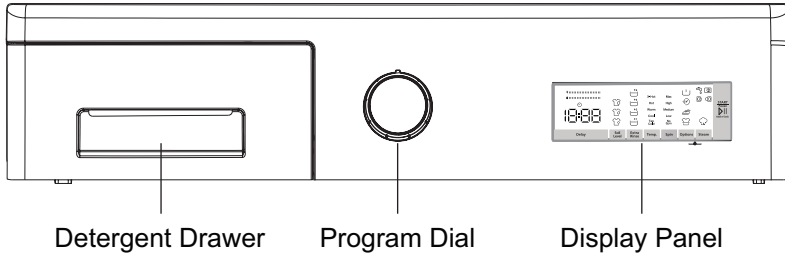

Detergent Drawer and Compartments

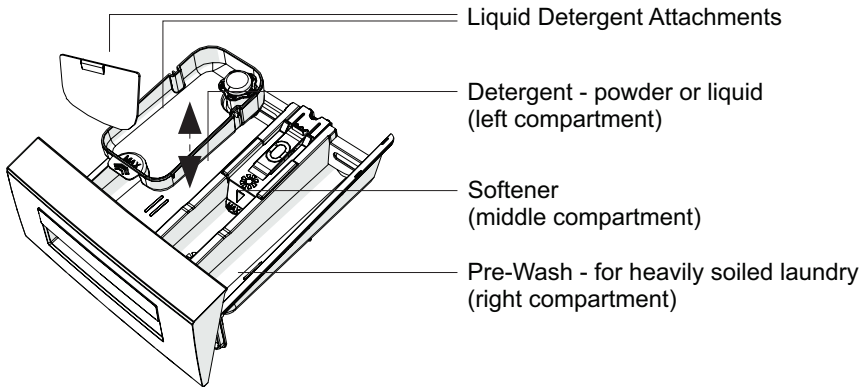

- The amount of detergent used depends on the load size and the soil level.
- Use detergents produced for automatic washing machines. Follow the manufacturer's instructions on the amount of detergent and softener to use.
- Put softener in the middle compartment and ensure not to exceed the Max level. Thick softeners may cause clogging of the drawer and should be diluted.
- Residue may build up in detergent and softener compartments. Fill these compartments only at the beginning of each wash.

Program Dial

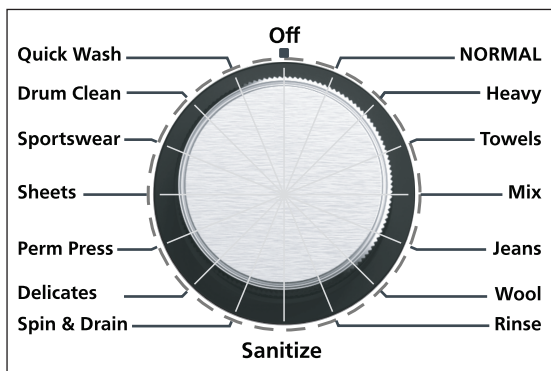

- The Program Dial should be in the Off position (no lights will appear around the dial).
- To select the desired program, turn the Program Dial either clockwise or counterclockwise until the light next to the selected program illuminates and you hear a beep.
- Ensure the display panel is illuminated with the default features.
- If the above does not happen, then turn the Program Dial to the Off position, and select the program again.
- **The wash program is successfully selected when the light on the dial next to the program is illuminated and the Display Panel is also illuminated with the default features.**
- Refer to the Wash Programs Table as a guide to select programs.
- For all programs there are default factory settings. Depending on the specific program, some features can be changed and options added.

Wash Programs Table

Program	Load Descriptions	Max Temp.* (Default)	Max Spin Speed* (Default)	Time (Mins)
NORMAL	Mixed clothes (shirts, pants, etc.)	Warm	Max	113
Heavy	Thick cottons	Hot	Max	131
Towels	Thick towels, cottons	Warm	Max	113
Mix	Mixed fabrics	Hot	Medium	118
Jeans	Jeans, pants, denim	Warm	Medium	100
Wool	Sweaters, scarves	Warm	Medium	58
Rinse	All types	Tap Cold	Max	35
Sanitize	All types	X-Hot	Medium	200
Spin & Drain	All types	NA	Max	17
Delicates	Silks, light fabrics	Warm	Medium	100
Perm Press	Cotton blends	Hot	High	120
Sheets	Bedsheets, linen	Hot	Medium	113
Sportswear	T-shirts, leggings	Warm	High	100
Drum Clean	NA	X-Hot	Max	90
Quick Wash**	Light fabrics	Cool	Medium	12

* Max Temperature and Spin Speed - can be decreased depending on wash program.

**For Quick Wash use less detergent.

Display Panel

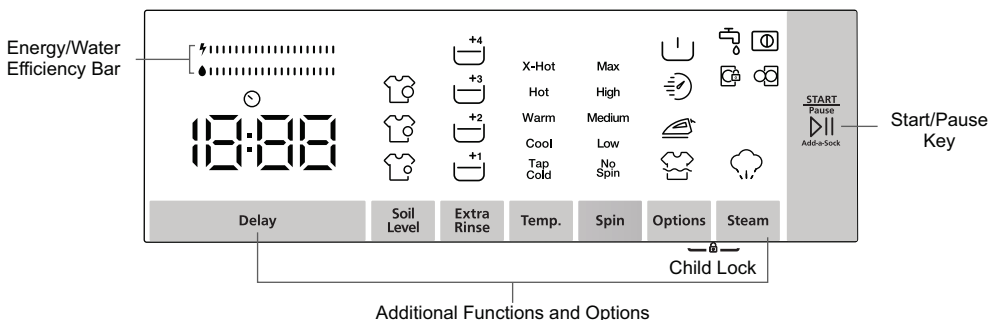

Display Panel and Features

Once the wash program has been selected, there are additional features and options that can be added to the program. It is not necessary to select additional functions and options. You can simply select the wash program on the Program Dial and then press the Start key and the wash cycle will begin with the pre-programmed default settings.

Each feature and option is explained below.

Note: Each wash program has a different set of features and options and not all features and options are available for all the programs.







Delay ☉ Press this key to delay the start of the wash program. The time icon ☉ and the delay time (1h) will appear on the Display Panel. Each time you press the Delay key, the time will increase in one-hour increments from 1 to 23 hours. Press the Start key to activate the program.

To cancel the delay, press the Delay key until it passes 23h or turn the Program Dial to Off and select the wash program again.

Soil Level 🧺 To change the soil level from the default, press the Soil Level key to select from 3 levels and the selection will illuminate on the Display Panel 🧺.

Extra Rinse 🧺 To add a rinse to the wash program, press the Extra Rinse key to select the number of rinses and the selection will illuminate on the Display Panel 🧺.

Temp. The default maximum temperature for the wash program selected will be illuminated on the Display Panel. To change the temperature, press the Temp. key to select from X-hot, Hot, Warm, Cool and Tap Cold. (Not all may be displayed.)

- Spin** The default maximum spin speed for the wash program selected will be illuminated on the Display Panel. To change the spin speed, press the Spin key to select from Max, High, Medium, Low and No Spin. (Not all may be displayed.)
- Options** Press the Options key to select any of the 4 options.
- Pre-wash**  This option allows an extra wash before the regular wash cycle. Remember to add detergent to the right compartment. Recommended for heavily soiled clothes.
- Rapid wash**  This option reduces the time, energy and water in the wash program. If the laundry is only half a load, it will be detected by the sensors and Rapid wash will automatically be enabled.
- Easy Ironing**  This option reduces wrinkles in clothes.
- Rinse & Hold**  This option keeps the laundry in the last rinse water. To finish the wash cycle, press the Start key. The water will drain but not spin.
- Steam** This is a default function that steams the laundry eliminating wrinkles.
- Child Lock** Press the Options and Steam keys simultaneously for at least 3 seconds until "CL" flashes on the Display Panel for 2 seconds and child lock is activated. Follow the same procedure to deactivate child lock and CL will disappear from the panel.
- Start/Pause** Press this key to start the wash program. When the cycle has already begun, press it again to pause the program. When you press the Start/Pause key, the unlock icon  on the Display Panel will change to the lock icon . The door is locked and cannot be opened until the end of the cycle. When the cycle ends, a beep will sound and End will show on the Display Panel and you can then open the door easily.
(After some time the Display Panel will go blank.)

For the first wash, run the Normal program without laundry and half fill detergent in the left compartment of the detergent drawer. This will remove any residue and water from the washer that has been tested in the factory.

Half-Load Detection System

Your washer features a half-load detection system.

If you put less than half the maximum load of laundry into the washer the sensor automatically detects this and selects the half-load function, regardless of the program you selected. The cycle adjusts the time depending on the load, thereby reducing the time to complete the program and uses less water and energy.

Door Lock

The door of the washer will remain locked while the program cycle is running or when the washer loses power.

To open the door when it is locked:

1. Turn off the washer. Remove the power plug from the mains socket.
2. Drain the wastewater (see instructions for cleaning the pump filter.)
3. Pull down the emergency opening mechanism using a flathead screwdriver and open the door at the same time.
4. Move the emergency opening handle to the original position.



Maintenance

To reduce the risk of electric shock, disconnect the Washer by removing the plug from the power socket before doing maintenance. Turning the controls to the Off position does not disconnect this washer from the power supply.

Turn off the water supply before starting maintenance and cleaning the washer.

CAUTION: Do not use solvents, abrasive cleaners, glass cleaners or all-purpose cleaning agents to clean your Washer. They may damage the plastic surfaces and other components with the chemicals they contain.

All replacement parts must be obtained from the manufacturer's authorized service center.

General Maintenance

Use mild soap and water and non-abrasive cloth to clean the outside of the Washer. Wipe dry with a soft cloth.

Check for metallic objects such as keys, clips, coins etc. in your Washer and remove them from the inside of the drum. These objects lead to the formation of rust stains in the drum. To clean rust stains, use a non-chlorine cleaner and follow the manufacturer's instructions. Never use steel wool or abrasive materials for cleaning rust stains.

- Unplug your washer and switch off the water supply if it is left unused for a long time. We also recommend that you leave the door open to prevent buildup of humidity inside the washer.
- In the event of a breakdown, unplug the washer from the mains supply and turn the water supply off. Do not attempt to carry out any repairs. Always contact an authorized service agent.

Cleaning Water Inlet Filters

Water inlet filters prevent dirt and foreign materials from entering the washer. If the hoses are connected to water supply and the faucet is turned on, but not enough water is flowing to the Washer, then the water inlet filters should be cleaned. It is recommended that the water inlet filters be cleaned every 2 months.

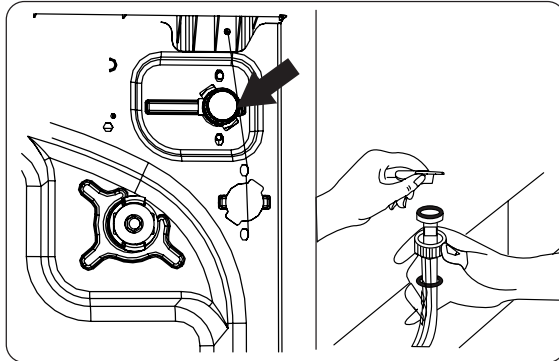

- Unscrew the water inlet hose(s) from the Washer.
- To remove the water inlet filter from the water inlet valve, use a pair of long-nosed pliers to gently pull on the plastic bar in the filter.
- A second water inlet filter is located in the faucet end of the water inlet hose. To remove the second water inlet filter, use a pair of long nosed pliers to gently pull on the plastic bar in the filter.
- Clean the filter thoroughly with a soft brush and wash with soapy water and rinse thoroughly. Re-insert the filter by gently pushing it back into place.

CAUTION: The filters at the water inlet valve may become clogged due to water quality or lack of required maintenance and may break down. This may cause a water leak. Any such breakdowns are out of the scope of the warranty.

Cleaning the Pump Filter

The pump filter system in your Washer prolongs the life of the pump by preventing lint from entering the washer.

Clean the pump filter every 2 months.

The pump filter is behind the cover at the front, lower right corner.

To clean the pump filter:

1. Before opening the filter cover, place a container under the filter cover to collect any water that may flow out of the Washer.
2. Use a flathead screwdriver or similar tool to open the pump cover.

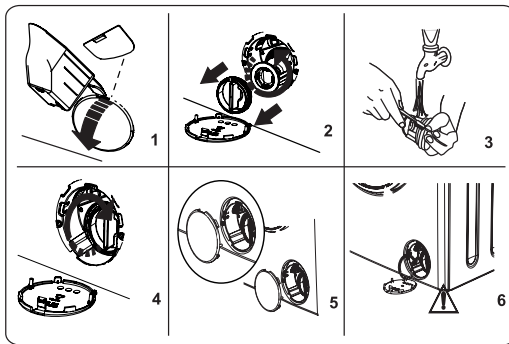

3. Insert the screwdriver at 12 o'clock position in the opening of the cover and gently press backwards. The cover will open.
4. Loosen the filter by turning counterclockwise and remove by pulling. Wait for the water to drain.
5. Remove any foreign materials from the filter with a soft brush.
6. After cleaning, re-fit the filter by inserting it and turning clockwise.
7. When closing the pump cover, ensure that the mountings inside the cover meet the holes on the front panel side.
8. Close the filter cover.

WARNING: The water in the pump may be hot, wait until it has cooled down before carrying out any cleaning or maintenance.

Cleaning the Detergent Drawer

Detergent may cause residual build up in the detergent drawer over time. Remove and clean the drawer every 2 months.

To remove the detergent drawer:

- Pull the drawer forwards until it is fully extended.
- Press the lever inside the detergent drawer and continue pulling to remove it completely.
- Disassemble the flush stopper and clean thoroughly to remove any softener residue. Refit the flush stopper after cleaning and check that it is inserted properly.
- Rinse the drawers with a brush and water.
- Carefully remove residue from inside the detergent drawer housing so that no debris falls inside the Washer.
- Dry the detergent drawer with a dry cloth and place it back in the Washer.
- Remove the liquid level detergent container and clean the detergent residue using water and a soft cloth. Replace the liquid detergent container and ensure that no residual material remains inside the siphon.

Do not wash your detergent drawer in a dishwasher.

Troubleshooting

In most cases, when your Washer fails to work, the problems arising can be easily solved without having to call for a technician. Before calling for assistance, always check these points.



Problem	Possible Cause	Solution
Machine does not start	Machine not plugged in.	Plug machine in.
	Fuses are faulty.	Replace the fuses.
	No mains power supply.	Check mains power.
	Start/Pause button not pressed.	Press the Start/Pause button.
	Program dial in Off position.	Turn the program dial to the desired program.
	The machine door is not completely closed.	Close the machine door.
Machine does not intake water	Water faucet is turned off.	Turn on the faucet.
	Water inlet hose may be twisted.	Check water inlet hose and untwist.
	Water inlet hose clogged.	Clean water inlet hose filters.
	Inlet filter clogged.	Clean the inlet filters.
	The machine door is not completely closed.	Close the machine door.
Machine does not discharge water	Drain hose clogged or twisted.	Check the drain hose, then either clean or untwist.
	Pump filter clogged.	Clean the pump filter.
	Laundry is too tightly packed together in the drum.	Spread your laundry in the machine evenly.
Machine vibrates	The feet have not been adjusted.	Adjust the feet.
	Shipping bolts fitted for transportation have not been removed.	Remove the shipping bolts from the machine.
	Small load in the drum.	This will not prevent operation of machine.
	Machine is overloaded with laundry or laundry is unevenly spread.	Do not overload the drum. Spread laundry evenly in the drum.
	Machine rests on a hard surface.	Do not set up Washing Machine on a hard surface.
Excessive suds formed in the detergent drawer	Excessive amount of detergent used.	Use less detergent.
	Wrong detergent used.	Only use HE detergents produced for automatic Washers.

Problem	Possible Cause	Solution
Unsatisfactory washing result.	Your washing is too soiled for the program selected.	Use the information in the program tables to select the most appropriate program.
	Amount of detergent used insufficient.	Use the amount of detergent as instructed on the packaging.
	There is too much laundry in your machine.	Check that the maximum capacity for the selected program has not been exceeded.
	Hard water.	Increase the amount of detergent following the manufacturer's instructions.
	Your laundry is too tightly packed together in the drum.	Check that your laundry is spread out.
As soon as the machine is loaded with water, water discharges.	The end of water drain hose is too low for the machine.	Check that the drain hose is at a suitable height.
No water appears in the drum during washing.	No fault. Water is in the unseen part of the drum.	
Laundry has detergent residue.	Non-dissolving particles of some detergents may appear on your laundry as white spots.	Perform an extra rinse, or clean your laundry with a brush after it dries.
Grey spots appear on the laundry.	There is untreated oil, cream or ointment on your laundry.	Use the amount of detergent as instructed on the packaging in the next wash.
The spin cycle does not take place or takes place later than expected.	No fault. The unbalanced load control system has been activated.	The unbalanced load control system will try to spread your laundry. The spinning cycle will begin once your laundry is spread. Load the drum evenly for the next wash.

Refer to the respective Installation, Operation and Maintenance sections in the manual to correct the problems.

Error Codes

The Washer is equipped with a built-in fault detection system. The Error Code flashes on the Display Panel. The most common error codes are listed below.

Error Codes	Possible Cause	Solution
E01 	The door of your machine is not shut properly.	Shut the door properly until you hear a click. If your machine persists to indicate fault, turn off your machine, unplug it and contact the nearest authorized service agent immediately.
E02 	The water pressure or the water level inside the machine may be low.	Check the faucet is fully turned on. Mains water may be cut-off. If the problem still continues, your machine will stop after a while automatically. Unplug the machine, turn off the faucet and contact the nearest authorized service agent.
E03 	The pump is faulty or pump filter is clogged or electrical connection of the pump is faulty.	Clean the pump filter. If the problem persists, contact the nearest authorized service agent.
E04	Your machine has excessive amount of water.	Your machine will discharge water by itself. Once the water has drained, turn off your machine and unplug it. Turn off the faucet and contact the nearest authorized service agent.

Technical Specifications

Model	CW 2240
Rated Voltage	120V/60Hz
Washing input power	60 W
Spin input power	320 W
Capacity	2.2 cu.ft.
Spin Speed	1400 rpm
Programs	15
Net Weight	164.24 lbs.
Dimensions (HXWXD)	33.27 x 23.5 x 22.9 inches



High Efficiency Dryer (Condensing)

Model - CD 4040 W/B/T

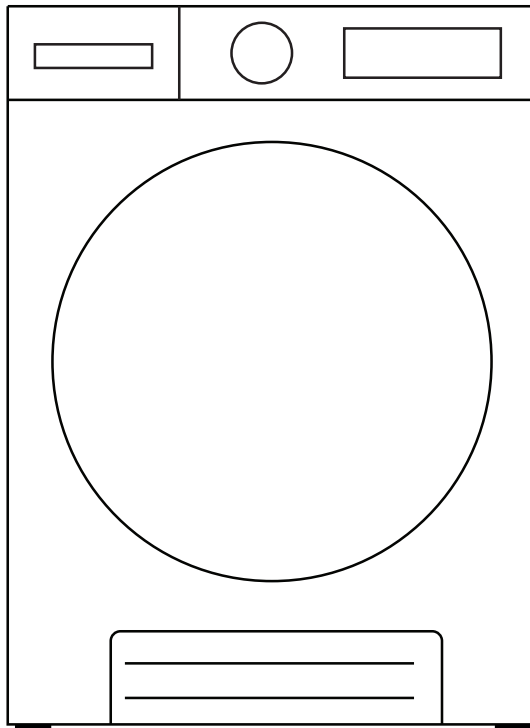

OWNER'S MANUAL

Please read the instructions carefully and keep for future reference. Information may be updated from time to time so please refer to the manual online for the latest version of the manual.

WARRANTY INFORMATION

Your appliance is protected by this warranty under normal, personal, family or household use for 2 Year Parts & Labor and limited commercial use (90 days) in USA and Canada.

WARRANTY

Conserv Appliances undertakes to the consumer/owner to repair or, at our option, to replace any part of this product which proves to be defective in workmanship or material under normal personal, family or household use in USA and Canada, for a period of two years parts & labor from the date of original purchase. For commercial use, the product is warranted for a period of 90 days.

During this period, we will provide all labor and parts necessary to correct such defect, free of charge, if the appliance has been installed and operated in accordance with the written instructions provided with the appliance. Ready access to the appliance, for service, is the responsibility of the consumer/owner. If unit installed in closet or cabinet, it should be removed for access by service technician. If this cannot be done, then there will be extra charge.

We may require return of products or parts to our warranty department for which the shipping charges are to be incurred by the consumer. If a return or replacement is required, allow 3-4 weeks to process. If unit is located more than 25 miles there will be a trip charge. If unit is in remote area more than 75 miles, customer will need to take the product to the technician's workshop. Replacement unit will be delivered with curb side delivery only. If Unit is installed in a 5th wheel RV, in a location behind the axle it won't be covered under warranty.

All repairs or replacements are warranted only for the remainder of the original warranty period. Charges may incur if warranty coverage is not applicable. Service would be provided from Monday to Friday between normal business hours.

GENERAL

Since it is the responsibility of the consumer/owner to establish the warranty period by verifying the original purchase date, Conserv Appliances recommends that a receipt, delivery slip or some other appropriate payment record be kept for that purpose. This warranty gives you specific legal rights, and you may also have other rights which vary from State to State.

You can register your warranty by either of following methods:

1. Scan the QR Code
2. Online at: ApplianceDesk.com/Warranty

QR Code



1. Open Smart Phone
2. Open Camera
3. Scan QR Code
4. Click the Link

WARRANTY SERVICE

This warranty is given by:

Conserv Appliances
10222 Georgibelle Drive, Suite 200,
Houston, TX 77043-5249

QUESTIONS / SERVICE

Phone/Text: 1-800-776-3538

Email: Service@ApplianceDesk.com

Web: www.ApplianceDesk.com

Exclusions

In no event shall Conserv Appliances be liable for incidental or consequential damages or for damages resulting from external causes such as abuse, operation misuse, neglect, alterations, normal wear and tear, incorrect voltage or acts of God. This warranty does not cover service calls which involve defective workmanship, damage due to other products while combined use with this product or materials covered by this warranty. Accordingly, diagnosis and repair costs for a service call which involves defective workmanship or materials will be the responsibility of the consumer-owner.

Most work is covered. The defining factor is has the appliance malfunctioned (Conserv Appliances is responsible) or has the customer omitted or done something to cause malfunction (customer is responsible).

THE FOLLOWING WORK ARE NOT COVERED UNDER WARRANTY:

Installation

1. Non-removal of shipping bolts, causing vibration, resulting in internal damage.
2. Non-adjustment of feet to level machine, causing vibration, resulting in internal damage.
3. Not conforming to minimum space requirements for built-in installation, causing excess heat and resulting in damage to internal components.
4. Installation in a corrosive environment.

Maintenance

1. Non-cleaning of lint filters and condenser.
2. Non-cleaning of vent fan & exhaust hose for lint, causing the unit to not dry properly.
3. Improper maintenance (such as, but not limited to, scale build-up, freeze damage, or vent blockage).

Damage

1. Breakage of cosmetic parts e.g., door handle, knob.

Other

1. Accident, abuse or misuse.
2. Using solvents to clean the machine causing damage.
3. Misapplication of this product e.g., use in a non household/commercial environment.
4. Any other cause not due to defects in materials or workmanship.
5. Problems or damage due to fires, flooding, electrical surges, freezing or any acts of God.
6. Force majeure.

Warranty Limitations

1. If a unit is located more than 25 miles away, there will be a trip charge.
2. If a unit is in a remote area more than 75 miles away, the machine should be taken to the technician's workshop.
3. If the unit is installed in a 5th wheel RV, in a location behind the axle, it will not be covered under warranty.
4. All repairs or replacements are warranted only for the remainder of the original warranty period.
5. If a return or replacement is required, allow 3-4 weeks to process.
6. Replacement units will be delivered with curbside delivery only.
7. We may require the return of products or parts to our warranty department for which the shipping charges are to be pre-paid by the consumer / owner.
8. Charges may be incurred if warranty coverage is not applicable.
9. Service would be provided from Monday to Friday between normal business hours.

GENERAL

Since it is the responsibility of the consumer / owner to establish the warranty period by verifying the original purchase date, Conserv Appliances recommends that a receipt, delivery slip or some other appropriate payment record be kept for that purpose. This warranty gives you specific legal rights, and you may also have other rights which vary from state to state.

All rights reserved. Manual subject to change without notice.

California Proposition 65

WARNING: This product contains chemical known to the State of California to cause cancer and birth defects or other reproductive harm.

Table of Contents

Safety	1
Installation	4
Electrical Connection	5
Connection to Water Outlet	8
Connecting the Water Discharge Hose	8
Operations	9
Control Panel	9
Program Dial	10
Dry Programs Table	11
Display Panel	12
Maintenance	14
Troubleshooting	16
Technical Specifications	17
Error Codes	18

SAFETY

Your safety and the safety of others are very important.

Please read and follow the important safety warnings in this manual and on your appliance.

⚠ DANGER

Danger indicates a hazardous situation that, if not avoided, will result in death or serious injury.

⚠ WARNING

Warning indicates a hazardous situation that, if not avoided, could result in death or serious injury.

⚠ CAUTION

Caution indicates a hazardous situation that, if not avoided, could result in minor or moderate injury.

To reduce the risk of fire, electric shock, or injury to persons when using your appliance, always follow basic precautions.

⚠ WARNING Risk of Fire

- Do not wash items that have been previously cleaned in, washed in, soaked in, or spotted with gasoline, dry-cleaning solvents, or other flammable or explosive substances, as they give off vapors that could ignite or explode.
- Do not add gasoline, dry-cleaning solvents, or other flammable or explosive substances to the wash water. These substances give off vapors that could ignite or explode.
- Do not store flammable liquids near the appliance.
- The sulfur content of paint removers may cause corrosion. Never use paint removing materials in the appliance.
- Never use products that contain solvents in the appliance.
- Please ensure that items loaded into your appliance do not have plastic, metallic, or sharp objects such as pins, keys, or coins.
- Do not tamper with controls.
- Do not repair or replace any part of the appliance or attempt any servicing unless specifically recommended in the manual or in published user-repair instructions that you understand and have the skills to carry out.
- To reduce the risk of electric shock, disconnect this appliance from the power supply before attempting any maintenance. Turning the controls to the OFF position does not disconnect this appliance from the power supply.

WARNING Risk of Burns

Do not touch the drain hose or any discharged water while your appliance is running. The high temperatures pose a burn risk.

Risk of Injury or Death from Electrical Current

- Do not connect your appliance to the mains electricity supply using an extension cord.
- Do not insert a damaged plug into a socket.
- Never remove the plug from the socket by pulling the cord. Always hold the plug.
- Never touch the power cord/plug with wet hands as this could cause a short circuit or electric shock.
- Do not touch your appliance if your hands or feet are wet.
- A damaged power cord/plug can cause fire or give you an electric shock. A damaged cord or plug must be replaced by a qualified technician.
- Connect to a dedicated circuit.

Risk of Falling and Injury

- Do not climb on your appliance.
- Do not reach into the appliance if the drum is rotating.
- Ensure hoses and cables are secured and do not present a tripping hazard.
- Do not turn your appliance upside down or on its side.
- Do not lift your appliance using the door.
- The appliance must be carried by at least 2 people.

Child Safety

- The appliance is not intended for use by people (including children) with reduced physical, sensory or mental capabilities, or lack of experience and knowledge unless they have been given supervision or instruction concerning use of the appliance by a person responsible for their safety.
- Children of less than 3 years should be kept away unless continuously supervised.
- Do not leave children unattended near the appliance. Children might lock themselves in the appliance resulting in risk of death.
- Children should not play with the appliance.
- Cleaning and maintenance should not be done by children.
- Do not allow children to touch the glass door during operation. The surface becomes extremely hot and may cause damage to skin.
- Poisoning and irritation may occur if detergent and cleaning materials are consumed or come into contact with the skin and eyes. Keep cleaning materials out of the reach of children.
- Keep packaging material away from children. The packaging of the appliance could be hazardous to children. Do not allow children to play with the packaging or small parts from the appliance.
- Keep the packaging materials in a place where children cannot reach them or dispose of them appropriately.
- Before the appliance is removed from service or discarded, remove the door to prevent child entrapment.

Safe disposal

Dispose off this appliance in accordance with local regulations.

Installation

Please check the packaging of the washer and the outer surface of the washer once the packaging has been removed. Do not operate the washer if it appears damaged or if the packaging has been opened.

Your dryer must only be installed by an authorized service agent.

- The operating temperature of the dryer is 41°F to 95°F.
- Do not install or store this dryer where it will be exposed to the weather or outdoors.
- Install your dryer in a location that can be fully ventilated and preferably has constant air circulation.
- Do not install the dryer on a carpet or surfaces that would prevent the ventilation of its base.
- Ensure that the door of your dryer is not restricted and can be opened fully.
- To ensure silent and vibration-free operation of the dryer place the dryer on a flat, smooth and firm surface. Ensure the back of the dryer is against a wall.

Leveling

- Level your dryer using the adjustable feet. Never insert cardboard, wood or other similar materials under the washer to level it.
- To increase the height of the dryer, turn the feet clockwise. To decrease the height of the washer, turn the feet counterclockwise.
- Once the dryer is level, tighten the locking nuts by turning them clockwise.

Under Counter Installation

- Leave at least 1 inch (3 cm) of space between the side and rear walls of the product and the underside of the counter top when installing your dryer under a counter.
- Assembly / disassembly under the counter must be done by an authorized technician.

Stacking kit

If you are going to place the dryer above the washer, you must obtain a stacking kit that is specific for this model of dryer from Customer Service.

Do not place the washer above the dryer.

Electrical Connection

⚠ ATTENTION: There is risk of fire and electric shock.

- Your dryer is set to 208-240 V and 60 Hz.
- The mains cable of the dryer is equipped with a special plug. This plug must be connected to a grounded socket protected by a fuse of 16 Amperes as indicated on the type plate. The fuse current rating of the power line where the outlet is connected must also be 16 amperes. Consult a qualified electrician if you do not have such an outlet or fuse.
- Our company cannot be held responsible for damages resulting from usage without grounding.

👤 IMPORTANT: Operating your dryer at low voltage values will shorten the service life and decrease the performance of your machine.

Electric Installation

- The clothes dryer installation must be performed by a qualified installer.
- Install the appliance according to the manufacturer's instructions and local codes.
- To reduce the risk of severe injury or death, follow all installation instructions.
- If local codes do not permit the 3-wire power supply cord connection, only 4-wire power supply cord must be used.
- Do not use an extension cord.

Electrical Connection

Before you start, determine which receptacle you have.

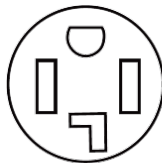

4-Wire receptacle
(14-30R)

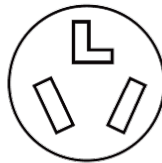

3-Wire receptacle
(10-30R)

- If you have 4-wire receptacle, you must use UL listed NEMA 14-30P 240V / 30A 4-wire supply cord with ring terminals or spade terminals with upturned ends. Supply cord must be type SRDT and at least 5 ft. length.
- If you have 3-wire receptacle, you must use UL listed NEMA 10-30P 240V / 30A 3 wire supply cord with ring terminals or spade terminals with upturned ends. Supply cord must be type SRDT and at least 5 ft. length.

4- Wire Power Supply Cord Connection

▲ WARNING Before making the connection, disconnect the power.
Use UL listed 240V / 30A power supply cord.

Your dryer was equipped with strain relief. Use this strain relief in connection.

1. Remove the screw and terminal box cover.

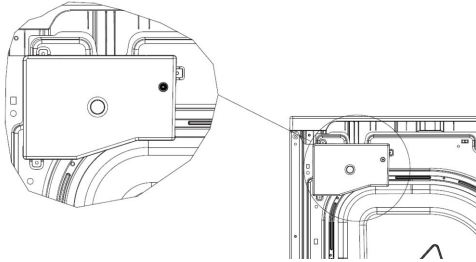

2. Remove the clamp of the strain relief which has already attached on your machine. Then pass the clamp through the supply cord and put the supply cord through the main body of the strain relief. Be sure that wire insulation of the cord inside the strain relief.

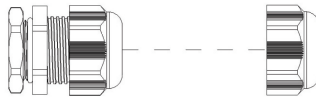

3. Remove the terminal block screws which are indicated by A and grounding screw which is indicated by B. Neutral ground conductor (central terminal) is provided in the dryer as a closed loop.

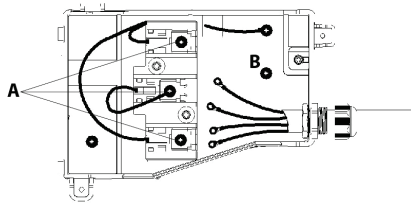

4. Connect the ground conductor (green wire) under the terminal B. Then connect the neutral wire (white wire) to center of the terminal. Neutral ground conductor of the dryer should remain on the center terminal. Be sure that neutral ground conductor of dryer and neutral wire of supply cord connected to center terminal together. Tighten all screws.
5. Connect remaining wires under the outer terminals of the block and tighten all screws. After every connection is completed, tighten strain relief clamp in order to secure the supply cord. Finally, cover up the box cover.

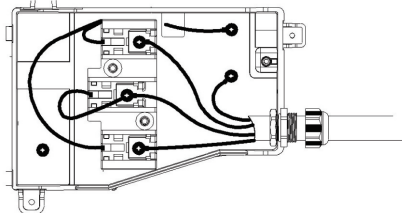

3- Wire Power Supply Cord Connection

▲ WARNING Before making the connection, disconnect the power.
Use UL listed 240V / 30A power supply cord.

Your dryer was equipped with strain relief. Use this strain relief in connection.

1. Remove the screw and terminal box cover.

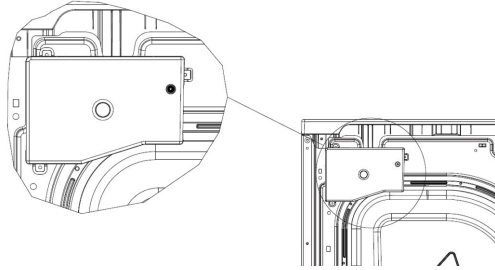

2. Remove the clamp of the strain relief which has already attached on your machine. Then pass the clamp through the supply cord and put the supply cord through the main body of the strain relief. Be sure that wire insulation of the cord inside the strain relief.

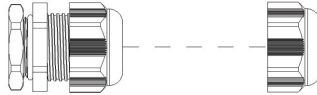

3. Remove the terminal block screws which are indicated by A and grounding screw which is indicated by B. Neutral ground conductor (central terminal) is provided in the dryer as a closed loop.

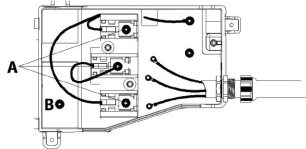

4. Remove the neutral ground conductor from central terminal and connect the neutral wire of the supply cord under the central terminal of the block. Tighten the screw.

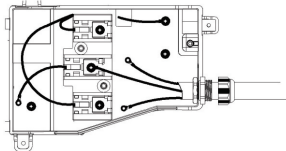

5. Connect the neutral ground conductor under the screw B. Then connect the remaining supply cord wires under the outer terminals of the block. Tighten all screws. After every connection is completed, tighten strain relief clamp in order to secure the supply cord. Finally, cover up the box cover.

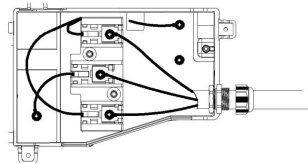

Connection to Water Outlet (with optional drain hose)

Water accumulates in the water tank during the drying process. You must empty the accumulated water after each drying process. Instead of periodically emptying the water tank, as an option, you can also use a drain hose to directly drain the water outside.

Connecting the Water Discharge Hose

1. Pull and take out the end of the hose at the back of the dryer. Do not use any tools to take out the hose.
2. Fit one end of the water discharge hose, which is provided with the product, to the slot from which you have removed the hose.
3. Fix the other end of the water discharge hose directly to the water outlet or sink.

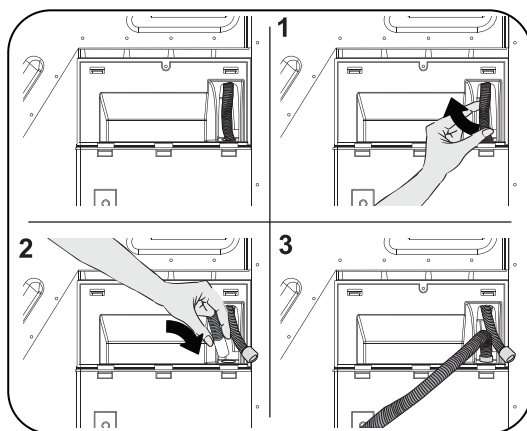

⚠ ATTENTION: The hose must be connected in a manner that it cannot be displaced. If the hose comes out during water discharge, there might be flooding.

🚫 IMPORTANT: The water discharge hose must be installed at a height of 31 inch (80 cm) maximum.

🚫 IMPORTANT: Ensure that the water discharge hose is not bent, twisted or obstructed in any way.

Operations

WARNING - To reduce the risk of fire, electric shock, or injury, read **IMPORTANT SAFETY INSTRUCTIONS** before operating the dryer.

Ensure the Dryer is plugged in correctly.

Ensure that children and pets have not climbed into the appliance and keep them away from the appliance when it is in use.

Control Panel

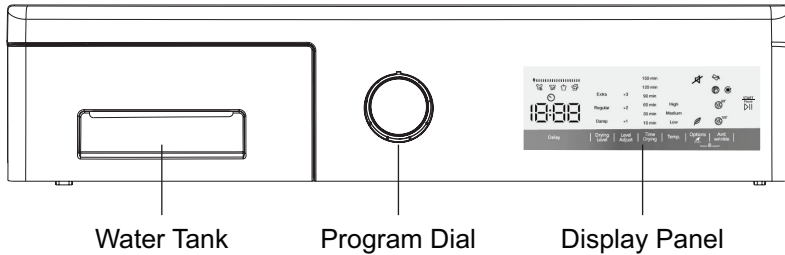

- Please ensure that items loaded into your dryer do not have objects such as lighters, keys, coins, etc.
- Dry the same type of materials together in a load.
- Shake out and load each item of laundry separately (it will enhance drying).
- Close zips, fasten any hooks and place small or delicate items in a net bag.
- Reverse items such as printed t-shirts and items that have embroidery, sequins, etc.
- Do not overload the dryer. You should be able to comfortably place your hand above the loaded laundry, ensuring there is enough space for the clothes to tumble, allowing air flow to dry the clothes properly.
- Check that no items of laundry are trapped between the rubber seal and the door.
- Gently push the door until it clicks shut. Ensure the door is fully closed, otherwise the program will not start.

Do not open the door while the dryer is in operation. If you have to open it, press the Start/Pause key and then open it. Close the door quickly and restart the program by pressing the Start/Pause key again.

Program Dial

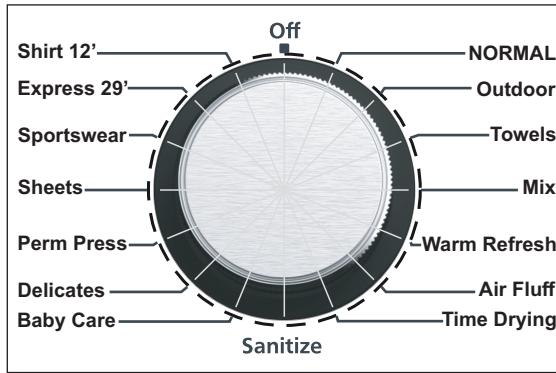

- The Program Dial should be in the Off position (no lights will appear around the dial).
- To select the desired program, turn the Program Dial either clockwise or counterclockwise until the light next to the selected program illuminates and you hear a beep.
- Ensure the display panel is illuminated with the default features.
- If the above does not happen, then turn the Program Dial to the Off position, and select the program again.
- **The dry program is successfully selected when the light on the dial next to the program is illuminated and the Display Panel is also illuminated with the default features.**
- Refer to the Dry Programs Table as a guide to select programs.
- For all programs there are default factory settings. Depending on the specific program, some features can be changed and options added.

Dry Programs Table

Program	Load Descriptions	Spin Speed	Temp.* (Default)	Time (Mins)
NORMAL	Mixed clothes (shirts, pants, etc.)	1000	High	158
Outdoor	Jackets	800	Med	43
Towels	Thick towels, cottons	1000	High	71
Mix	Mixed fabrics	1000	Med	81
Warm Refresh	Woolens, refresh all types	-	Low	-
Air Fluff	All types (refresh with no hot air)	-		-
Time Drying	All types (10-150 mins)	-	Low	-
Sanitize	All types	1000	High	59
Baby Care	Delicate baby clothes	1000	Med	68
Delicates	Silks, light fabrics	600	Low	41
Perm Press	Cotton blends	800	Med	61
Sheets	Bedsheets, linen	800	Low	127
Sportswear	T-shirts, leggings	800	Med	53
Express 29'	Light fabrics	1200	High	29
Shirts 12'	Light fabrics, shirts (damp dry)	1200	Med	12

*Temperature can be changed depending on the dry program.

Normal Program

The Normal program uses a sensor dry function which monitors the moisture in the clothes and adjusts the dry time. When you start this program, the time on the Display Panel will show 158 minutes. However, depending on the load and the drying process, the time can be decreased significantly, and the dryer will run only long enough to dry the clothes and then stop.

Normal cycle was used to rate the dryer for energy efficiency. The normal cycle defaults to regular drying level and high temperature setting.

This product meets the ENERGY STAR® guidelines for energy efficiency.

Cycles with the low heat setting save the most energy. Use the low heat setting for auto dry cycles without any level adjust to save on energy and prevent over drying your clothing.

Display Panel

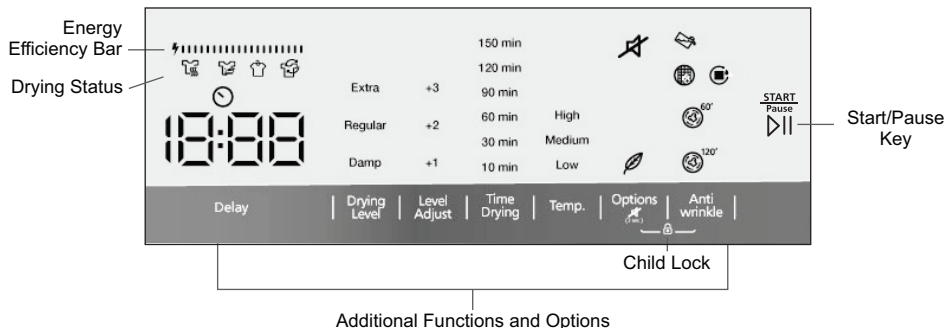

Display Panel and Features

Once the dry program has been selected, there are additional features and options that can be changed or added to the program. It is not necessary to select additional functions and options. You can simply select the dry program on the Program Dial and then press the Start key and the dry cycle will begin with the pre-programmed default settings.

Note: Each dry program has a different set of features and options. Depending on the dry program selected, not all features and options are available.

Delay ☉ Press this key to delay the start of the dry program. The time icon ☉ and the delay time (1h) will appear on the Display Panel. Each time you press the Delay key, the time will increase in one-hour increments from 1 to 23 hours. Press the Start key to activate the program.

To cancel the delay, press the Delay key until it passes 23h or turn the Program Dial to Off and select the dry program again.

Drying Level To change the drying level from the default, press the Drying Level key to select from 3 levels and the selection will illuminate on the Display Panel: Extra, Regular, or Damp.

Level Adjust To get clothes even more dry, press the Level Adjust key to select +1, +2 or +3 and the selection will illuminate on the Display Panel.

Time Drying This key can only be used when the Time Drying program has been selected. Press the Time Drying key to select the number of minutes to dry clothes: 10, 30, 60, 90, 120 or 150.

Temp The default maximum temperature for the dry program selected will be illuminated on the Display Panel. To change the level of hot air, press the Temp. key to select from High, Medium, and Low. (Not all may be displayed.)

Options

Press the Options key to select Delicate drying . The Delicate option lets the dry program run at low temperature and for a longer period of time.

Anti wrinkle

This is a default function that rotates the drum after the dry program ends, thereby eliminating wrinkles. Depending on the Dry Program, the anti wrinkle feature will operate for either 60 or 120 minutes. The icon illuminates on the Display Panel.

Child Lock

Press the Options and Anti wrinkle keys simultaneously for at least 3 seconds until "CL" flashes on the Display Panel for 2 seconds and child lock is activated. Follow the same procedure to deactivate child lock and CL will disappear from the panel.



Cancel beep

At the end of each dry program the dryer will sound a beep to let you know the program has ended. Should you want to silence the beep, it can be cancelled by pressing the Anti wrinkle key for 2 seconds.

Start/Pause

Press this key to start the dry program. When the cycle has already begun, press it again to pause the program. When the cycle ends, a beep will sound and End will show on the Display Panel.
(After some time the Display Panel will go blank.)

Alert Indicators: Alert icons illuminate on the Display Panel that remind you to perform specific maintenance activities:

- Empty the water tank 
- Clean lint filter 
- Clean condenser 

Drying Status: These icons indicate the drying status.



Drying



Damp Dry



Regular dry



End

Energy Consumption Display



The energy consumption display shows the energy consumption of the selected program. The bigger the display, the more the energy consumption. The energy consumption level increases or decreases depending on the fabric type, duration of the selected program, the drying level and the spinning speed.

Maintenance

⚠ IMPORTANT: Do not use industrial chemicals to clean your dryer.

Cleaning the Lint Filter

⚠ IMPORTANT: DO NOT FORGET TO CLEAN THE LINT FILTER AFTER EACH USE.

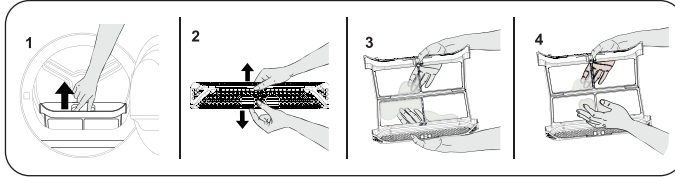

To clean the lint filter:

1. Open the door.
2. Pull up the lint filter to remove it.
3. Use your hands or a soft cloth to clean the lint.
4. Close and replace the lint filter.

Periodically remove and wash the filter with warm water and thoroughly dry it before reinstalling it.

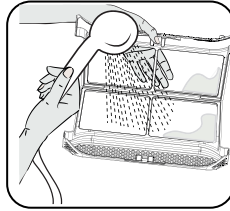

Emptying the Water Tank

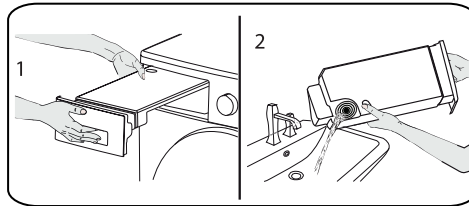

1. Pull out the drawer cover and carefully take out the tank.
2. Empty the water from the tank in the sink.
3. If there is lint accumulated on the discharge cap in the tank, clean it with water.
4. Replace the water tank.

⚠ IMPORTANT: Never remove the water tank when the program is running. The water condensed in the water tank is not suitable for human consumption.

⚠ IMPORTANT: DO NOT FORGET TO EMPTY THE WATER TANK AFTER EACH USE.

Cleaning the Condenser

👉 IMPORTANT: Clean the condenser once a month.

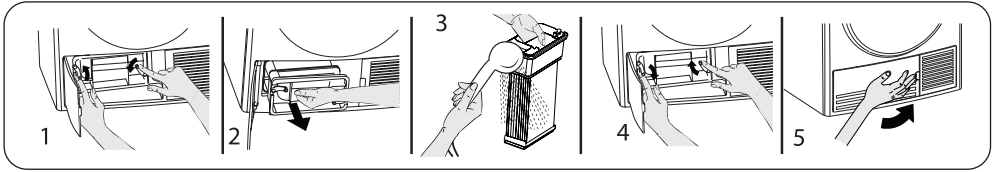

Wait for the dryer to cool down before cleaning the condenser.

1. Open the plinth and release the 2 cover locks of the condenser.
2. Hold the condenser by the plastic part and pull it out.
3. Clean it with a showerhead and wait for the water to drain off.
4. Fully insert the condenser into its seat and lock the 2 locks.
5. Close the plinth cover.

Cleaning the Moisture Sensor and Door

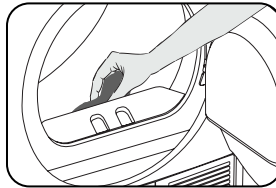

Inside the dryer, there are moisture sensors that detect whether the laundry is dry.

To clean the sensors:

1. Open the door.
2. If the dryer is still hot due to the drying process, wait for it to cool down.
3. Using a soft cloth soaked in vinegar, wipe the metal surfaces of the sensor and dry them.

👉 IMPORTANT: CLEAN THE METAL SURFACES OF THE SENSORS EVERY QUARTER.

Do not use metal tools to clean the metal surfaces of the sensor and the door.

Clean the door including the inner surfaces and the gasket with a soft, damp cloth.

⚠ WARNING: Due to the risk of fire and explosion, do not use solution agents, cleaning agents or similar products when cleaning the sensors.

Troubleshooting

In most cases, when your Dryer fails to work, the problems arising can be easily solved without having to call for a technician. Before calling for assistance, always check these points.

PROBLEM	POSSIBLE CAUSE	SOLUTION
The drying process takes a long time.	The surface of the lint filter might be clogged.	Wash the filter with lukewarm water.
	The condenser might be clogged.	Clean the condenser.
	The ventilation grills in front of the machine might be closed.	Open the doors/windows to prevent the room temperature from rising too much.
	There might be a layer of limescale on the humidity sensor.	Clean the moisture sensor.
	The dryer might be overloaded with laundry.	Do not overload the dryer.
	The laundry might be insufficiently spun.	Select a higher spin speed on your washing machine.
Laundry comes out damp at the end of the drying process.	 The laundry that comes out hot at the end of the drying process generally feels more humid.	
	The program used might not be suitable for the type of laundry.	Check the care labels on the laundry items, select a suitable program for the type of laundry and additionally, use the time programs.
	The surface of the lint filter might be clogged.	Wash the filter with lukewarm water.
	The condenser might be clogged.	Clean the condenser.
	The dryer might be overloaded with laundry.	Do not overload the dryer.
	The laundry might be insufficiently spun.	Select a higher spin speed on your dryer.
The dryer cannot be opened or the program cannot be started. The dryer does not get activated when adjusted.	The dryer might not be plugged in.	Make sure that the plug is fitted in the socket.
	The door might be open.	Make sure that the door is properly closed.
	You might not have set a program or pressed the Start/Pause key.	Make sure that the program has been set and the dryer is not in the Standby (Pause) mode.
	Child lock might be active.	Deactivate the child lock.
The program has been interrupted for no reason.	The door might not be closed properly.	Make sure that the door is properly closed.
	There might have been a power failure.	Press the Start/Pause key to start the program.
	The water tank might be full.	Empty the water tank.
Clothes have shrunk, felted or deteriorated.	The program used might not be suitable for the type of laundry.	Check the care labels on the laundry items, select a suitable program for the type of laundry.

PROBLEM	POSSIBLE CAUSE	SOLUTION
Water leaking from the door.	There might be lint accumulated on the inner surfaces of the door and on the surfaces of the gasket of the door.	Clean the inner surfaces of the door and the surfaces of the gasket of the door.
The door opens on its own.	The loading door might not be closed properly.	Push the loading door until you hear the closing sound.
The water tank warning symbol is on/flashing.	The water tank might be full.	Empty the water tank.
	The water discharge hose might be bent.	If the product is connected directly to the water outlet, check the water discharge hose.
The condenser cleaning warning symbol is on.	The condenser might be unclean.	Clean the condenser.
The filter cleaning warning symbol is on.	The lint filter might be unclean.	Clean the filter.
	The filter seat might be clogged by lint.	Clean the filter seat.
	There might be a layer that causes obstruction on the surface of the lint filter.	Wash the filter with lukewarm water.
The program can not be started and the filter warning led is blinking	The filter seat might be clogged by lint.	Clean the filter seat.
	There might be a layer that causes obstruction on the surface of the lint filter.	Wash the filter with lukewarm water.
	The condenser may not be placed.	Replace the condenser.
The program can not be started and both condenser and filter warning leds are blinking	The condenser and filter may not be placed.	Replace the filter and condenser.
	The filter and condenser warning leds are blinking even though the filter and condenser are placed.	Call technical service.

Technical Specifications

Brand	Conserv
Model Name	CD 4040
Height with feet not extended	32.3 inch (845 mm)
Height with feet fully extended	33.7 inch (855 mm)
Width / Depth	23.5 inch (596 mm) / 24 inch (609 mm)
Door Open Depth	43 inch (1090 mm)
Capacity (max.)	19.84 lbs (9 kg)
Net Weight (with glass door)	75.61lbs(34.3 kg)
Voltage / Power	208-240 V / 2700 W

*Dry laundry weight before washing.

 **IMPORTANT:** To improve the quality of the dryer, technical specifications are subject to change without prior notice.

 **IMPORTANT:** The values declared have been obtained in a laboratory environment according to the relevant standards. These values may change depending on the environmental conditions and use of the dryer.

Error Codes

The Dryer is equipped with a built-in fault detection system.

The Error Code flashes on the Display Panel.

The most common error codes are listed below.

Error Codes	Possible Cause	Solution
E00	T2 and T3 Touch UI card does not receive communication from main board.	Fix the connection. If connection is good, and error persists, change UI card. If error continues, change main board.
E03 	Aqua switch connector is disconnected. Faulty cable harness	Empty the water tank. Connect the aqua switch or if problem continues, change aqua switch. Change cable harness.
E04	Heater is not connected correctly. Measured resistance values through the heater connector are not correct. Disconnect between e-card and heater.	Fix heater connections. Change heater. Change main board or cable/wiring harness.
E05	Heater NTC connector may be disconnected.	Connect Heater NTC. Check cable/wiring harness. Check NTC resistance values and change heater or main board.
E06	Door NTC connector is disconnected. Door NTC short circuit.	Connect Door NTC. Check cable/wiring harness. Check door NTC resistance values and change door NTC or main board.
E08	Voltage fluctuation.	There may be voltage fluctuation in mains. Wait until voltage is appropriate for working range. If the voltage is ok, change main board.

An authorized service technician should make the repairs for these errors.

A separate service manual provides detailed instructions on how to correct the problems. Please contact customer service.

