

MONITOR STAND

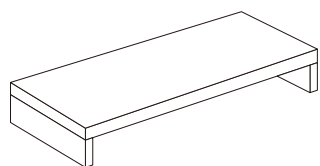

Included



10 Pins

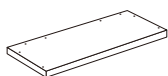

1 Horizontal zBoard

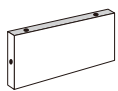

2 Back zBoards
adhesive strips on 2 edges

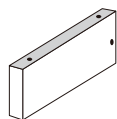

2 Side zBoards
adhesive strips on 2 edges

WARNING: CHOKING HAZARD
Small parts NOT for children under 3 years

Important

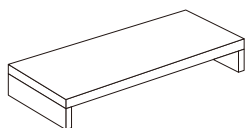

DO NOT place unit on its side or back as it will compromise its structural integrity.



- Assemble your unit on a flat even surface, carpet not recommended
- Furniture is for indoor use only

- When moving your Way Basics furniture, lift from the bottom
- Make sure zBoard surfaces are clean and dry

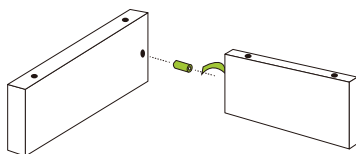

- 1** Carefully remove the 3M protective layer, insert alignment pin to connect back and side zBoards.

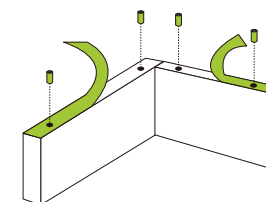

- 2** Carefully remove the rest of the 3M protective layers. Place alignment pins in vertical zBoards.

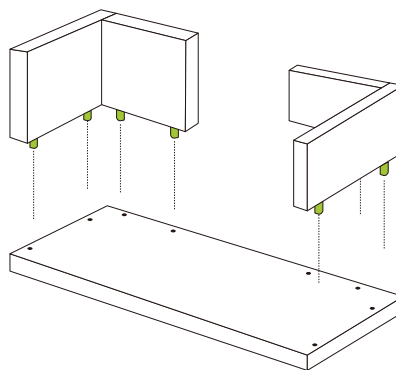

- 3** Connect the horizontal zBoard with the assembled back and side zBoards.

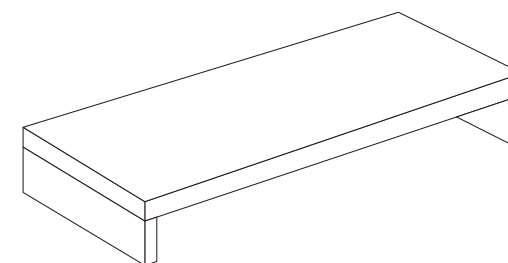

- 4** Easy, done! Maximum weight capacity 30 pounds. Visit links below for more details. Enjoy building possibilities!

