



# 52"/60" 3-BLADE Ceiling Fan Without Light

User Manual

## GET MORE SUPPORT

If you experience any issues while operating our products, please directly reach out to our Customer Support via Amazon Orders. Or you can send your inquiry to our Official Customer Support at:

 [support@depuley.com](mailto:support@depuley.com)

 (001)201-365-0018



# BRAND STORY

## "Whispering Breezes: The BvenuBigLite Ceiling Fan Light - A Fusion of Style and Comfort"

In the heart of every home, there's a story waiting to be told. At BvenuBigLite, we believe that every product we craft is not just an item for sale, but a chapter in the lives of our customers. Our Ceiling Fan Light is more than a mere appliance; it's a testament to our commitment to creating products that blend seamlessly into the narrative of your home.

**The BvenuBigLite Experience:** BvenuBigLite's Ceiling Fan Light is designed with the philosophy that comfort and style should never be mutually exclusive. We've taken the essence of a gentle summer breeze and encapsulated it within the sleek, modern design of our fan. With a variety of finishes and styles to choose from, our fan light is not just a product; it's a promise of a refreshing, inviting atmosphere that enhances the ambiance of any room.

**The Fusion of Form and Function:** Our Ceiling Fan Light is more than just a decorative piece. It's a testament to BvenuBigLite's dedication to innovation and functionality. With energy-efficient motors and whisper-quiet operation, our fans are designed to provide a cool breeze without disturbing the tranquility of your space. The integrated LED light not only saves energy but also offers a warm, inviting glow that sets the mood for any occasion.

**The BvenuBigLite Promise:** At BvenuBigLite, we don't just sell products; we build relationships. Our Ceiling Fan Light is backed by our unwavering commitment to quality and customer satisfaction. We stand by our products with a comprehensive warranty and a dedicated customer service team that's always ready to assist. We believe that every interaction with BvenuBigLite should be as comforting and reliable as the products we create.

**The Story Continues:** With every purchase, you're not just buying a Ceiling Fan Light; you're joining the BvenuBigLite family. We take pride in being a part of your home's story, and we're here to ensure that every chapter is filled with comfort, style, and the gentle whisper of a refreshing breeze.

Choose BvenuBigLite's Ceiling Fan Light, and let us be a part of your home's story. Together, we'll create an environment that's not only beautiful but also a place where memories are made and friendships are nurtured. After all, at BvenuBigLite, we don't hunt for sales—we build lasting friendships.



### 01 30-day money-back guarantee

If for any reason, within 30 days of receiving your order, you may return your undamaged BvenuBigLite product to us for a full refund.

### 02 5-year quality guarantee

If the product results in quality-related defects within 5-years from the date of purchase, please contact us [support@depuley.com](mailto:support@depuley.com) immediately. We solemnly promise to take full responsibility for the quality of our products, and will provide you with the most satisfactory solutions. And no need to return the original product. You don't need to pay any additional fees.

### 03 Quick Response within 12 Hours

If you encounter any issues or defects before or after product installation, be sure to get in touch with customer support: [support@depuley.com](mailto:support@depuley.com) immediately. Our team will make things right and respond to your request within 12 hours. Please do not initiate a self-service return, which will result with delay of your time and the loss of shipping cost reimbursements.

### 04 Free user support

Not sure how to get your BvenuBigLite product working properly? Contact our world-class, friendly support team: [support@depuley.com](mailto:support@depuley.com) for immediate assistance.



Thank you for choosing BvenuBigLite.  
We are here to support you every step of the way.

Active **20%** off  
discount  
in next purchase

“Order ID”



[support@depuley.com](mailto:support@depuley.com)

## Contact US

01

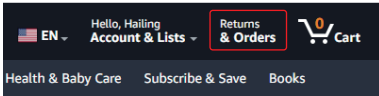

Log into your Amazon.com account,click  
“Returns&Others” on the top-right corner.

02

ORDER # 111-1111111-1111111

[View order details](#)

Find your order in the list and click “View order details”

03

Delivered Nov 27, 2022  
Your package was left near the front door or porch.  
Track package



Sold by [Depuley](#)  
Return eligible through Jan 31, 2023

Click the “Store Name” following the Sold by, below the  
product title.

04

Have a question for BvenuBigLite Ceiling Fan?

[Ask a question](#)

Click the button “Ask a question”, on the top-right  
corner, to contact the seller.



### WARNING

**To avoid fire, shock, and serious personal injury, please read the following instructions carefully. Important Safety instructions.**

- Before installing the fan, disconnect the power by removing fuses or turning off circuit breakers.
- Make sure the installation site you choose allows a minimum clearance of 7 feet from the blades to the floor and at least 30 inches from the tip of the blades to any obstruction (see the picture at the last page).
- If you are mounting the fan on a ceiling outlet box, use a metal sturdy base. Secure the box directly to the building structure. The outlet box and its support must be able to support the moving weight of the fan at least 45 pounds. Do not use a plastic outlet box. Attach the mounting brackets by winding the hardware provided with the can to the ceiling outlet box.
- If you are mounting the fan to a joist, make sure it is strong enough to support the moving weight of the fan (at least 45 pounds).
- After installing the fan, make sure all the connections are secured. This will prevent the fan from falling.
- Do not insert anything into the fan blades while the fan is operating.
- Turn the fan off and wait for it to stop before reversing fan direction.
- To reduce risk of electrical shock and personal injury, do not install the fan on a sloped ceiling.
- To reduce the risk of electrical shock and personal injury, do not use this fan with any solid-state.
- To reduce risk of personal injury, use only the two steel screws and lock washers provided with the fan for mounting the outlet box.
- The largest angle for angled mount is 15° (see the picture at the next page).

### RISK OF ELECTRIC SHOCK

- Before you start installing this ceiling fan, disconnect the power supply by turning off the circuit breaker.
- All electrical connections must be in accordance with local standard National Electrical Code (NEC) and ANSI/NFPA 70.
- Consult a qualified electrician if you are unfamiliar with proper electrical wiring connections.
- Do not alter, re-locate, or remove wiring when nothing goes wrong with the product.
- Double-check all connections and screws to be sure they are tight and correct.
- Verify whether the supply voltage is correct by comparing it with the product information.

### RISK OF INJURY

- Keep all the parts of this product away from children. The package contains many small or heavy parts that may bring children the risk of injury.
- Make sure to install all parts firmly enough in case they fall while running. Carefully check all screws, bolts, and washers on the fan assembly to ensure they are secured.
- Wear safety gloves and safety glasses always when installing or removing the light or the fan, or performing maintenance. Some parts of the components are sharp and may hurt your hands; please make sure you are wearing safety gloves when touching and installing the components.
- Wear rubber-soled shoes and work on a sturdy ladder.

### MAINTENANCE TIPS:

- Periodically cleaning your ceiling fan is the only required maintenance. When a soft brush or lint-free cloth to avoid scratching the paint, please turn off the electrical power before you clean your fan.
- Do not use water when cleaning your ceiling fan. It could damage the motor or the blades or even cause an electrical shock.
- The motor has permanently lubricated ball bearings. No need to oil.

**MAKE SURE THE POWER IS OFF IN THE ELECTRICAL PANEL BOX BEFORE YOU DO ANY CLEANING OR REPAIRS.**



### WARNING

To avoid serious injury or death, turn off the power at the circuit breaker before installing the fan.



**TURN OFF**

### IMPORTANT

To avoid abnormal operation, do not connect the product to the dimmer switch or fan speed switch.



### Applicable to only one type of ceiling



**Downrod Mount**



**Sloped Ceiling Mount**



### Installation distance reference

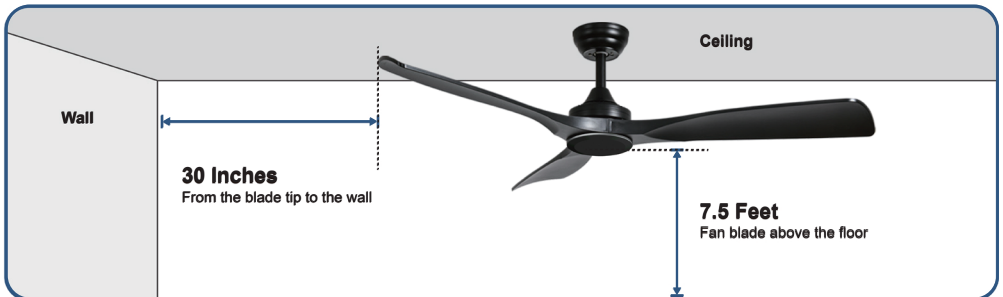

### TOOLS NEEDED



**Phillips Screwdriver**



**Wire Stripper**



**Step Ladder**



**Safety Gloves**



If you have trouble reading the instructions, please scan the QR code to watch the installation video.



01



02



03

Need a Video instruction Guide?  
Please scan the QR code

**If the QR code is invalid, please contact us for the video.**

This instruction manual applies to the following products:





### Notice:

The quantity listed above is the number required for installation. If there is a missing part in your package, please reach out to us [support@depuley.com](mailto:support@depuley.com).

# Section 1

## Hanger Bracket



Difficulty Level: ★☆☆☆☆

Let's move towards success with a relaxed start !

### Needed Accessories



x1



x4

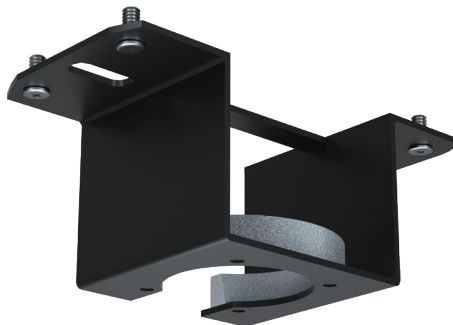



# Installation Steps



## Wood Ceiling

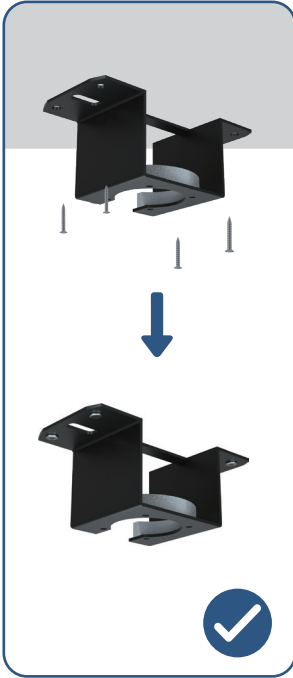

## Concrete Ceiling

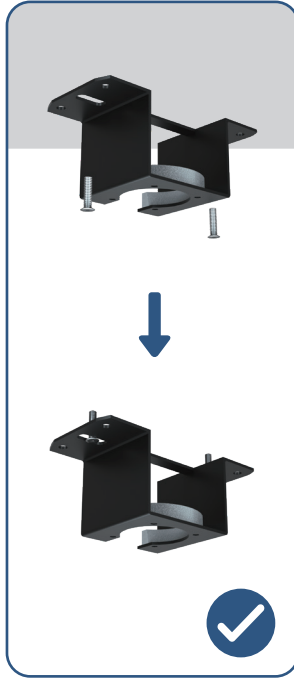

## Junction Box

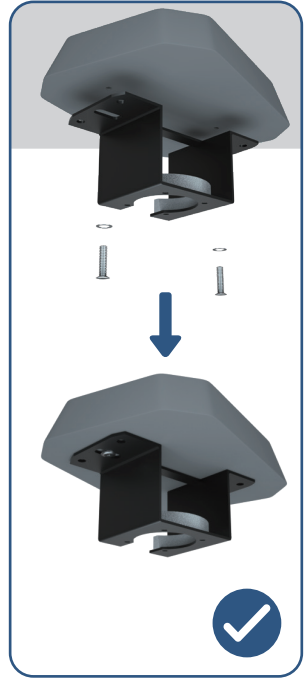

Don't Install On Sloped Ceiling Mount



# Section 2

## Downrod & Motor



Difficulty Level: ★ ★ ★ ★ ★

There will be some wiring involved, but don't worry, I'm sure you can do it !

### Needed Accessories

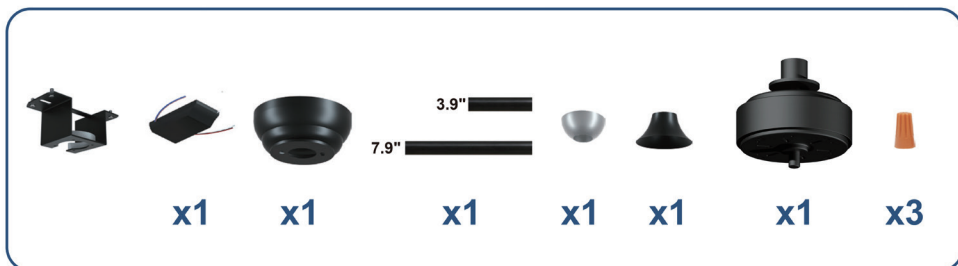



# Installation Steps

Hanger Bracket    Downrod & Motor    Blades

01

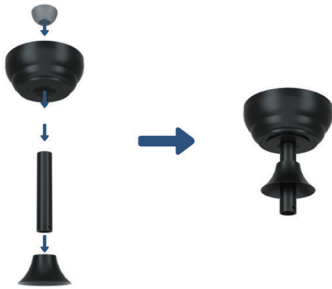

02



03

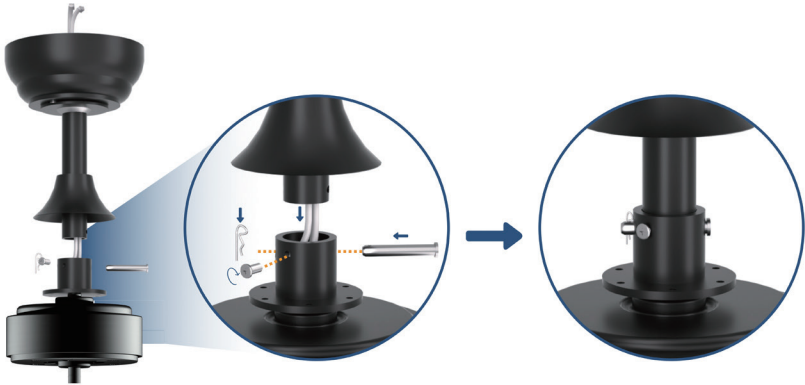

04

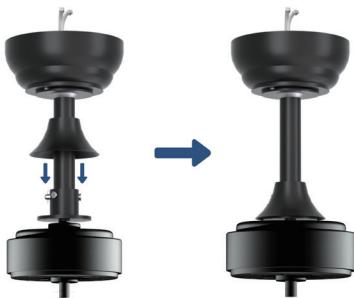

05





# Installation Steps

Hanger Bracket    Downrod & Motor    Blades

06

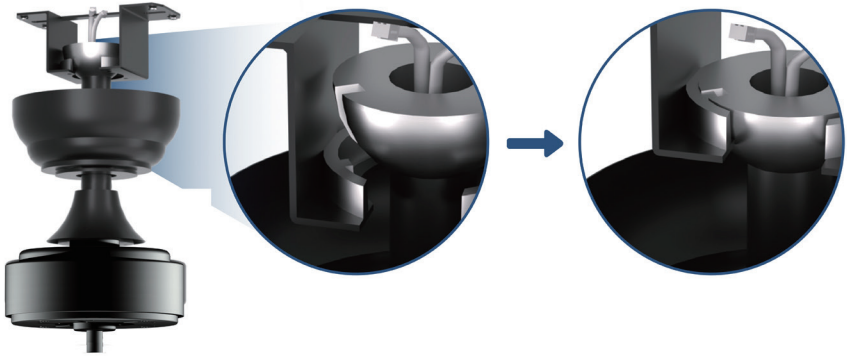

07





# Installation Steps



08



09



Good! You've finished the hardest part!



# Section 3

## Blades



Difficulty Level: ★★☆☆☆

There is a lot of repetitive work in this part.  
Please be more patient. Victory is ahead!

### Needed Accessories



x3



x6



x1





# Installation Steps

Hanger Bracket    Downrod & Motor    **Blades**

01





# Installation Steps

Hanger Bracket   Downrod & Motor   **Blades**

02



## Congratulations on Your New Fan Installation and Thank You for Choosing BvenuBigLite!

**Dear Valued Customer,**

We hope this message finds you well and enjoying the refreshing breeze from your newly installed ceiling fan light!

At BvenuBigLite, we are thrilled to have been a part of your home improvement journey. How does it feel to have completed the installation yourself? We're sure the sense of accomplishment is as exhilarating as the cool air from your fan!

By now, you've likely transformed your space with the perfect blend of light and airflow, all while saving a significant amount on professional installation costs. You deserve to celebrate your DIY success with a well-earned break, perhaps a relaxing evening in with your family or a special dinner out.

We applaud your initiative to take on the installation process yourself. It's customers like you who inspire us to create products that are not only high-quality but also accessible and user-friendly. Your confidence in your abilities and in our product is a testament to the trust you've placed in BvenuBigLite.

Should you encounter any challenges or have any feedback regarding the installation process or our instructions, please don't hesitate to reach out to us. Your insights are invaluable to us, and we're here to support you every step of the way.

Thank you once again for choosing BvenuBigLite for your home comfort needs. We are committed to providing you with exceptional products and services, and we look forward to being a part of your future projects.

Wishing you a delightful experience with your new fan light and many more successful DIY endeavors!

Best regards,  
BvenuBigLite



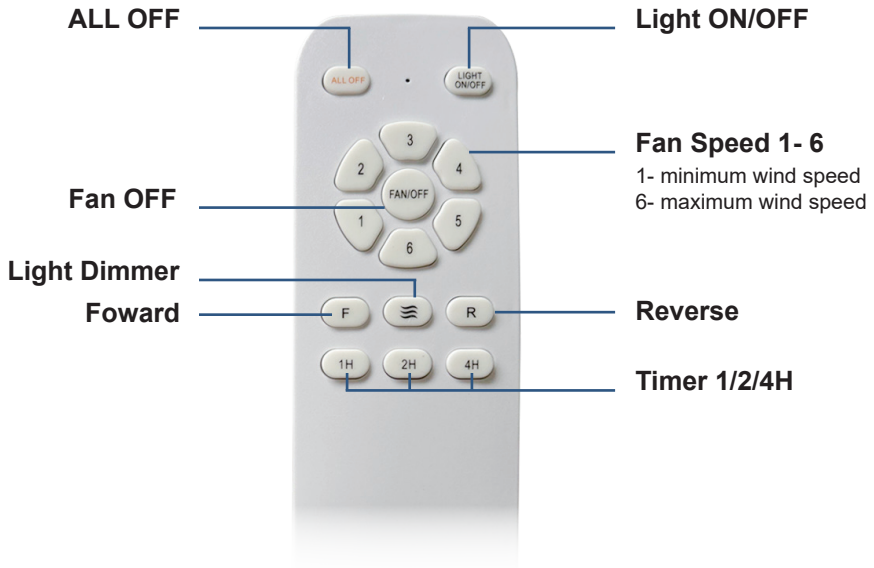

## Remote Control

### Points For Attention



- **Install 1.5\*2 volt battery**(not included)  
(To prevent damage to transmitter, remove the battery if not used for a long time)
- **Do not place the remote control in an excessively hot or humid environment**
- **Remote control learning code method:**  
Your remote control and ceiling fan light have been successfully paired initially. If you find that the remote isn't working properly during use, you can re-pair them by following these steps:

Step 1: Turn off the wall control switch.

Step 2: Turn on the wall control switch , within 3 seconds of the fan light lighting, press and hold the "**ALL OFF**" for 3 seconds Until the state of the light or motor changes then learn successfully..



Scan the QR code to download the remote control app.

## App Control

### Points For Attention



- **Connecting with mobile phone APP**  
Scan the QR code to download the "Smart Home Light" APP.
- Make sure that your Bluetooth are enable when using the Smart Home Light.
- **Bluetooth connection**  
Power off the receiver for 5 seconds Turn on the power and immediately press the key of  for 1 second then learn successfully.



Your fan may occasionally jerk forward or backward upon starting up, This is normal and does not affect the fan operation, Try these troubleshooting steps before contacting customer service.

| Problem ▶  | Solution  |
|--|---|
| <b>Fan not spinning</b>                            | <p>Make sure the fan is getting power.<br/>           Check your circuit breaker or fuse panel and wall switch for functionality.<br/>           Check to make sure the fan wires are correctly connected to the house wires.<br/>           Remote control must be paired with the fan within 1 minute after connecting the fan to the electrical.<br/>           Use a multimeter and test the adapter wiring harness to see if there is any electrical output.<br/>           All the pin wiring on the circuit board must be inserted tight and in the correct position.<br/>           Make sure the fan blades spin freely.<br/>           If you're using a wall control, check the power to the breaker from your control and try working your ceiling fan manually. (Normal switch only for the fan power on/off)</p>  |
| <b>Fan light not working</b>                       | <p>Make sure LED wires are connected to the circuit board.<br/>           Make sure the whole fan is powered.</p>   |
| <b>The fan is noisy and wobbling</b>               | <p>Check if the blade screws are NOT rubbing against any part of motor housing.<br/>           Check the pin wires are NOT connected against any moving parts.<br/>           Check the down fan cup is NOT hitting the motor.<br/>           Confirm the canopy is NOT touching the ceiling while the fan is in operation.<br/>           Check the down rod is NOT slanted.<br/>           Tighten any loose screws on the light kit, fan blades, motor coupling, down rod, brackets and mounting hardware.<br/>           Confirm the hanger ball is firmly seated in the mounting bracket.<br/>           The ceiling beam must meet the minimum tensile test strength of 30KG for installation.<br/>           Verify the wire connections are not rattling against each other.<br/>           Verify the fan blades are not cracked, if the fan blades are cracked, replace the damaged blades with a new blade set from the same brand as your ceiling fan to ensure compatibility<br/>           Confirm the light kit is NOT slanting and hitting the motor.</p> |
| <b>The fan or light automatically turns on/off</b> | <p>Confirm the circuit breaker is not malfunctioning.<br/>           Verify the wire connections are not frayed.<br/>           Check the app is not set to a timer or schedule.<br/>           Cut the fan power for 10 minutes then power on again.<br/>           All the pin wiring on the circuit board must be inserted tight and correct position.</p>   |



## GET MORE SUPPORT

We believe that after-sales service is an integral part of the customer experience, and we are dedicated to making it as seamless and hassle-free as possible. If you experience any issues while operating our products, please directly reach out to our Customer Support via Amazon Orders. Or you can send your inquiry to our Official Customer Support at:

 [support@depuley.com](mailto:support@depuley.com)

 (001)201-365-0018