

Owners Manual

TroposAir

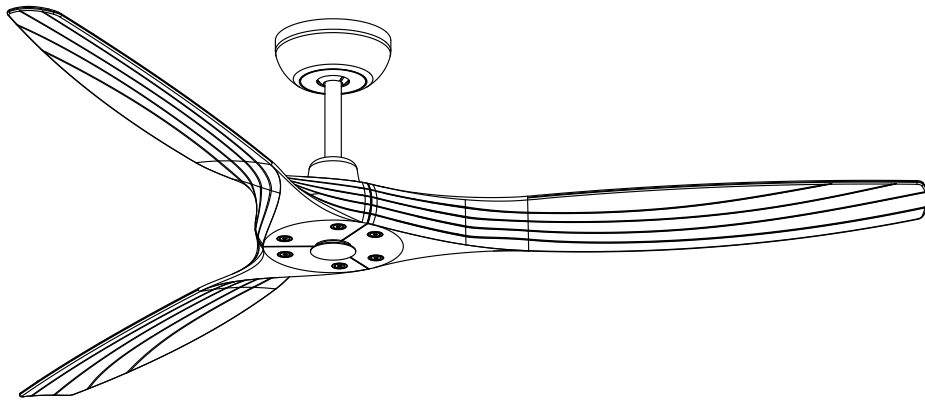

Solara+WiFi (3LN60+WiFi)

This instruction contains 11 pages:

Page 1: Read Safety instructions

Page 2: Unpack and inspect parts contained

Page 3~4: Notes before installation and Hanging system installation
/Blade installation

Page 5: Wire connection

Page 6: Canopy installation / Remote Transmitter assembly

Page 7: Operational instruction / Troubleshooting

Page 8~9: Remote Pairing Process

Page 10~11: WiFi Pairing



Toll Free: 1-855-676-7247

Net weight

5.2 KGS.

11.4 LBS.

WARNING : Read and follow these instructions carefully and be mindful of all warnings shown throughout.

READ AND SAVE THESE INSTRUCTIONS

WARNING : TO REDUCE THE RISK OF FIRE, ELECTRICAL SHOCK, OR INJURY TO PERSONS, PLEASE OBSERVE THE FOLLOWING :

- 1]. To ensure the success of the installation, be sure to read the instructions and review the diagrams thoroughly before beginning.
- 2]. **To avoid possible electric shock, be sure electricity is turned off at the main power box before wiring.**
All electrical connections must be made in accordance with local codes, ordinances and/or the National Electric Code. If you are unfamiliar with the methods of installing electrical wiring and products, require the services of a qualified and licensed electrician as well as someone who can check the strength of the supportive ceiling members and make the proper installations and connections.
- 3]. Make sure that your installation site will not allow rotating fan blades to come in contact with any object when fan is in operation. **Blades must mounted at least 7 feet from the floor.**
- 4]. If possible, mount ceiling fan on a ceiling joist - the joist must be able to support the motion and weight of the moving fan. If the fan will be mounted on a ceiling outlet box, a 4" x 2-1/8" deep METAL octagon box is required ; one UL listed as " suitable for fan support ". The box and its supporting members must not be able to twist or work loose. **DO NOT USE PLASTIC BOXES.** Installation on a concrete ceiling should be performed by qualified personnel.
- 5]. Blades should be attached after motor housing is hung and in place. Fan motor housing should be kept in carton until ready to be installed to protect its finish. If you are installing more than one ceiling fan, make sure that you do not mix fan blade sets.
- 6]. After making electrical connections, spliced conductors should be turned upward and pushed carefully up into outlet box. The wires should be spread apart with the grounded conductor and the equipment - grounding conductor on one side of the outlet box and the " HOT " wires on the opposite side.
- 7]. Electrical diagrams are for reference only. Light kits that are not packed with the fan must be UL/ETL listed and should be installed per the light kit's installation instructions.
- 8]. After fan is completely installed, check to make sure that all connections are secured to prevent fan from falling and/or causing damage or injury.
- 9]. The fan can be made to work immediately after installation. There is no need to oil your fan. The motor has permanently lubricated bearings.
- 10]. The fan must be turned off and stopped before reversing fan direction.
- 11]. **The fan is for downrod mount only.**
- 12]. **This fan is reversible.**
- 13]. **This fan is controlled by remote.**
- 14]. **This fan is suitable for damp location use.**

“ Special note: All green grounding wire(s) from fan must be attached to house Ground/Earth wire to prevent flickering of LED. ”

Unpack and inspect fan carefully to be certain all contents are included.



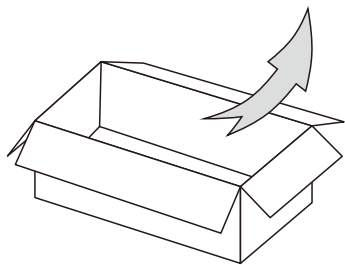
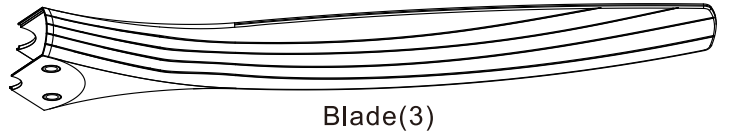
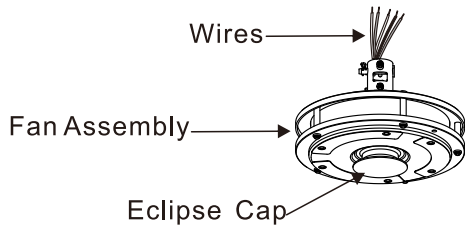
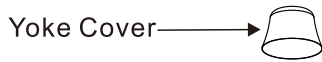

Unpack (Fan & Blades packed in one Box)



Unit pack / all in one box

Hardware Bag

For Mounting Bracket:

- Flat Washer x2 
- Spring Washer x2 
- Machine Screw x2 
- Wood Screw x2 

For Blade Installation:

A. Blade Screw x 7 (Top Side) (one spare screw included)



B. Blade Screw x 7 (Bottom Side) (one spare screw included)





L type hexagon wrench x 1



Warning:

Bag A: for top blade by Phillips screwdriver
 Bag B: for bottom blade by hexagon wrench
 See Blade assembly in Page 3

For Blade Balance :

- Balanced Slide x 1 
- Weight Block (3G x 5) 



For Wire Connection:

- Wire Nut x 8 

Remote Control (12V Battery Included)



Hardware Bag

- Wood Screw x 2 
- Wall plug anchor x 2 

WARNING: BLADES SHOULD BE AT LEAST 7 FEET FROM FLOOR

Note 1:

Turn off power at breaker box to avoid possible electrical shock.

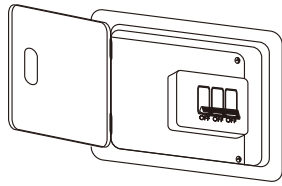

Note 2:

Use metal outlet box suitable for fan support. Outlet box must support 35 lbs min.

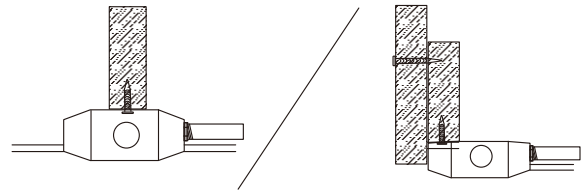

1. HANGING SYSTEM INSTALLATION

Installing mounting bracket to ceiling outlet box

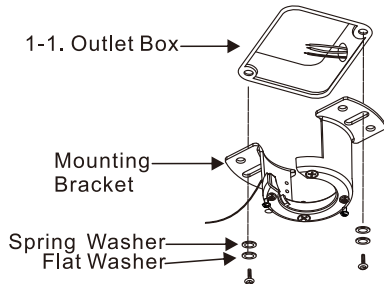

1-1. Install mounting bracket to outlet box on ceiling by using screws included with the outlet box and washers from the hardware bag.

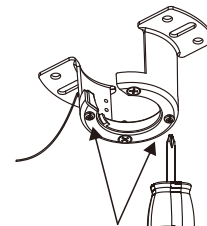

1-2. Screw (2)
(Loosening)

1-2. Loosen the screws at mounting bracket. **Do not remove.**

2. BLADE INSTALLATION

***Use Styrofoam as cushion for this step.**

**Special Note: Top blade screw are from Bag "A" using phillips screw driver.
Bottom blade screws are from bag "B" using L Hexagon Wrench.**

***Place the fan assembly on Styrofoam with yoke up.**

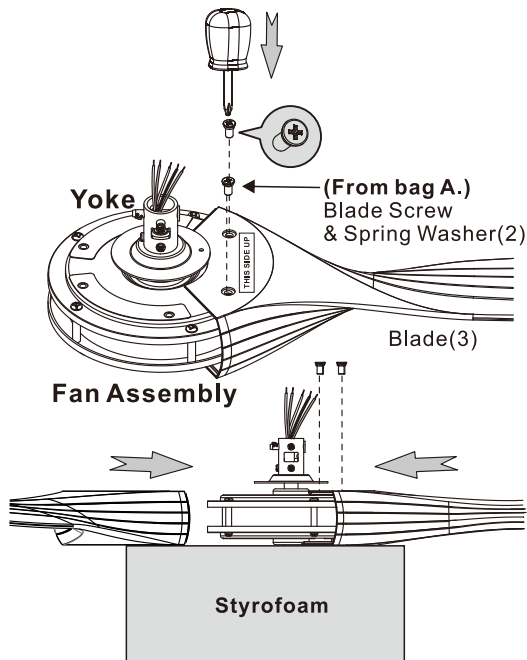

Attach blades to fan assembly by using screws(2) & spring washer(2) provided from hardware bag marked "A" on top of fan assembly.

***Make sure the label "THIS SIDE UP" must be on the top side.(Facing the ceiling)**

***Turning the fan assembly upside(Eclipse cap up).**

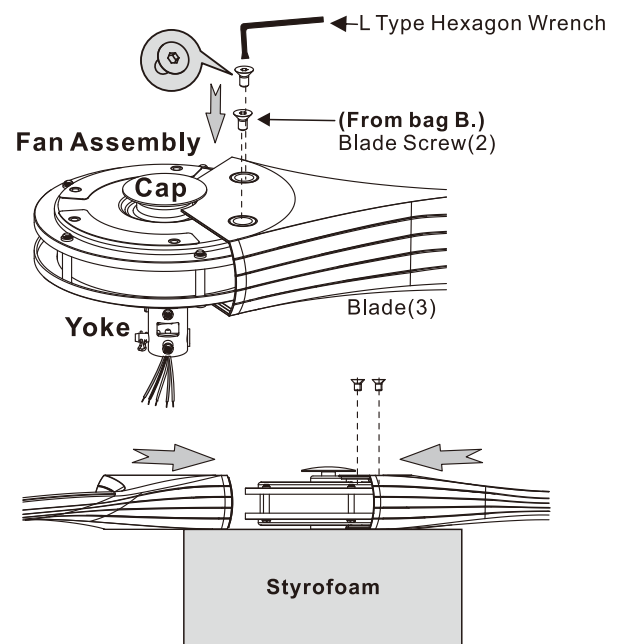

Attach screws(2) on bottom of fan assembly provided from hardware bag marked "B" by using L Type Hexagon Wrench provided from hardware bag. (* Repeat until all 3 blades are installed firmly.)

***Note: Make sure all blade washers & screws are tightened to avoid operating noise.**

3. DOWNROD INSTALLATION

Downrod Assembly

3-1. Cotter Pin Cross Pin

Wires

Yoke

3-2. Downrod Jam Screws (2) (Loosening)

Fan Assembly

3-1. Remove cross pin and cotter pin from downrod.
3-2. Loosen 2 downrod jam screws at yoke.

Downrod Assembly

3-3. Canopy

Deco Ring

Yoke cover

Fan Assembly

3-3. As shown above, insert yoke cover, deco ring, canopy onto downrod.

Lead wires

Yoke cover

Downrod Assembly

Yoke

Fan Assembly

3-4. Insert the lead wires through the downrod assembly.

Cross Pin

Canopy

Yoke cover

Downrod Jam Screws (2)

Cotter Pin

Fan Assembly

3-5. Insert downrod assembly into yoke and attach the cross pin through yoke & downrod, secure with cotter pin.

Hex Nut

Downrod Jam Screws (2) (Tightening)

3-6. Make sure the position of the Hex nut must be on side of jam screw head, before tighten jam screw.
3-7. Tighten 2 jam screws to secure downrod.

Canopy

Yoke cover

Downrod Jam Screws (2)

Hex nut

Fan Assembly

3-8. Use spanner to tighten the Hex nut, so the jam screw will not loose.
3-9. Pull down the yoke cover to cover yoke.

4. HANGING THE FAN ONTO MOUNTING BRACKET

Mounting Bracket

4-1. Lift fan assembly onto mounting bracket.

Mounting Bracket

Ridge

Ball Groove

4-2. Rotate fan so that the groove on the ball engages the ridge in the mounting bracket.

5. WIRE CONNECTION

5-1. Verify that serial Number & Model Number match on the Receiver and Transmitter

NOTICE :

Many remote sets for DC fans look the same. This remote set is pre-paired and labeled at the factory, please note the following before operation:

- 1a. The Remote Model Number on transmitter and receiver must be the same.
- 1b. The Remote Serial Number will be the same on a pre-paired remote set. If it is different, it will need to be paired (See page 8)
2. The Fan Model Number label must be the same as the fan's model number in front page (3LN60) for proper operation. (There is no Fan Model Number on transmitter.)
3. Do not mix the remote sets if you are installing more than one fan.

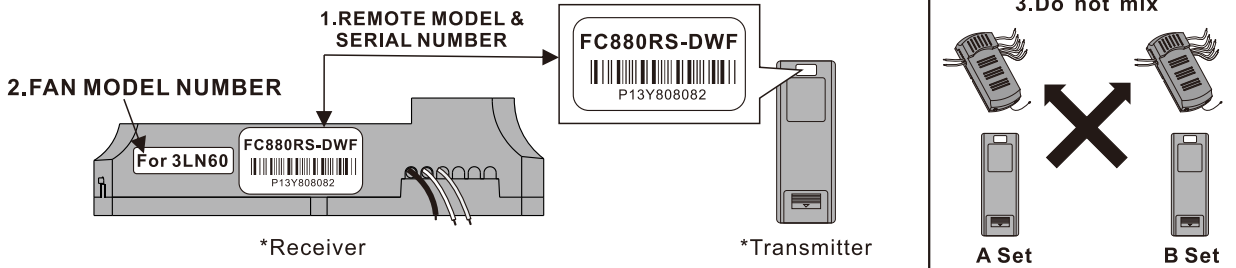

5-2. Insert receiver into mounting bracket

NOTE: Do not squeeze all the wires while inserting the receiver into the mounting bracket.

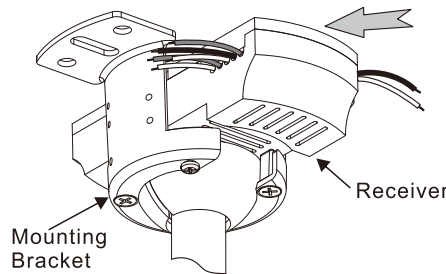

5-3. Making electrical wire connection

The standard lead wire is 54" long.

You may need to cut all 5 lead wires (from motor) to proper length & strip them for wire connection to make it easier for Canopy installation.

Follow diagram below and make sure that all exposed wires are secured inside wire nuts.

Note : Wires from house may vary in color. If the house wires do NOT include a ground wire (green) AND the optional #630 LED Light Kit is being installed, to prevent flickering, this unit must be grounded/earthed to the home's ground/earth; please consult an electrician.

After wiring is completed, gently push wires into junction box with wire nuts pointing upward.

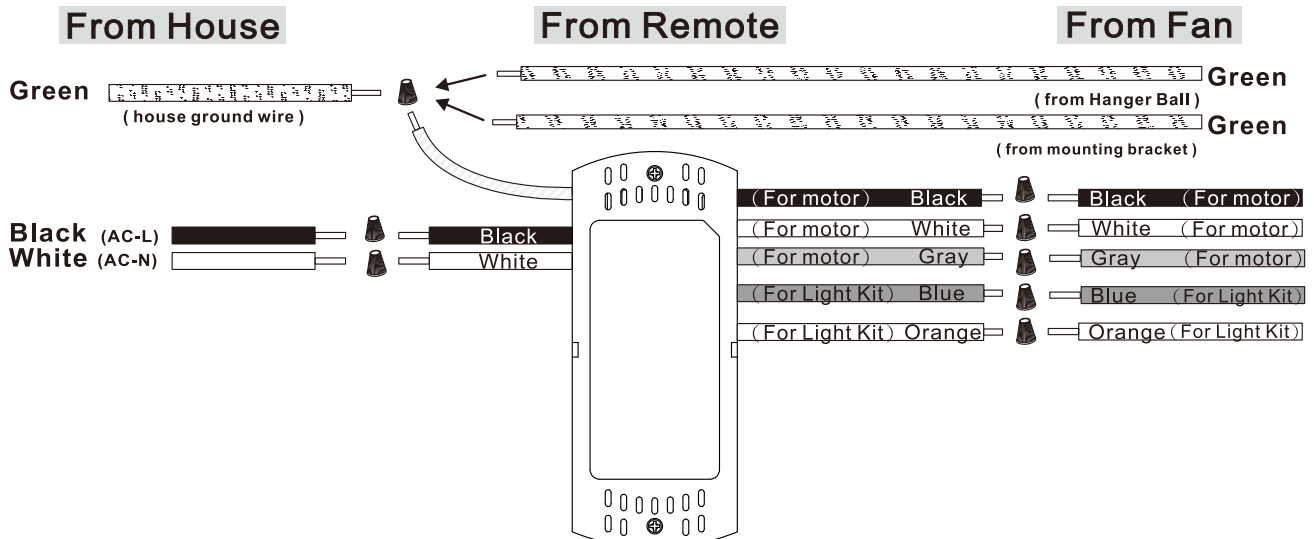

“ Special note: All Green grounding wires, from Hanger ball/Mounting bracket/Receiver, must be well attached to House Ground/Earth to prevent flickering of LED. ”

6. CANOPY INSTALLATION

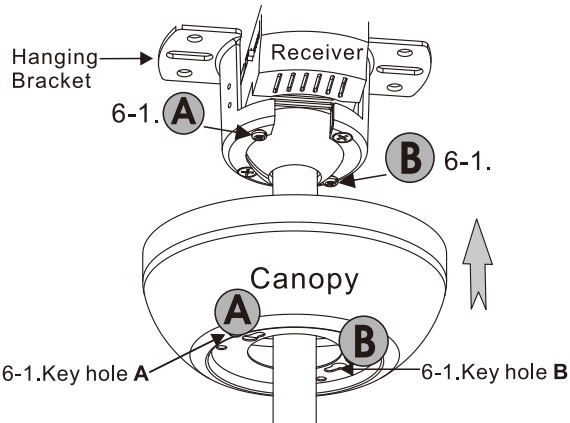

Note: Two screws are installed on mounting bracket for canopy installation.

6-1. Push canopy up until the two pre-screwed screws on the mounting bracket are engaged with the two key holes on canopy.

6-2. Before rotating the canopy, make sure Key hole A & B of the canopy correspond to A & B positions of the hanging bracket.

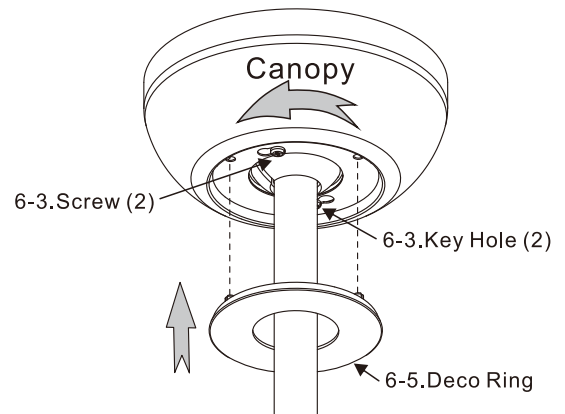

6-3. Rotate canopy slightly until the two pre-installed screw heads are engaged in the narrow end of key holes.

6-4. Tighten both screws.

6-5. Aligning the nubs from Deco Ring to 3 holes on the canopy, push Deco Ring up and snap into the canopy.

7. REMOTE TRANSMITTER ASSEMBLY

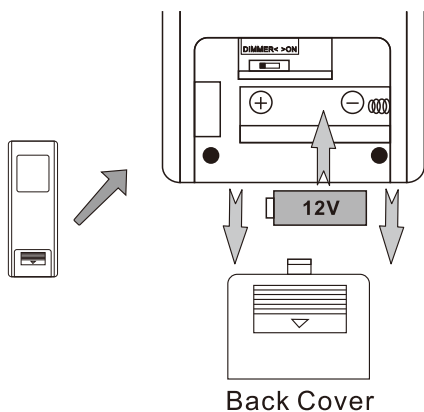

7-1. Install the battery

Remove the back cover and install the 12V battery. (Included from remote box)

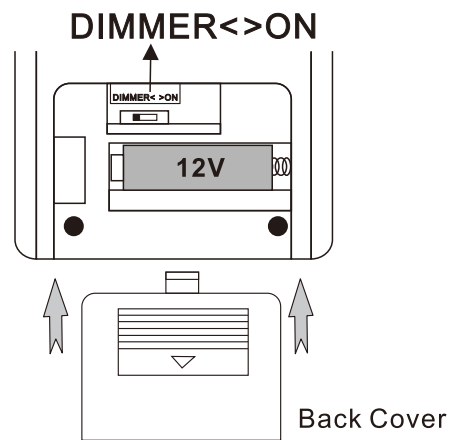

7-2. Check the dip switch position

(Original dip switch is on Dimming position)
Set dip switch in **DIMMER** position for LED dimming.
Set dip switch in **ON** position for LED ON/OFF only.

7-3. Re-install the back cover.

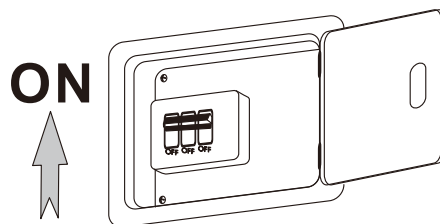

**Turn on power at breaker box, the fan is ready for operation!
(The receiver will have beep sound)**

8. OPERATIONAL INSTRUCTION

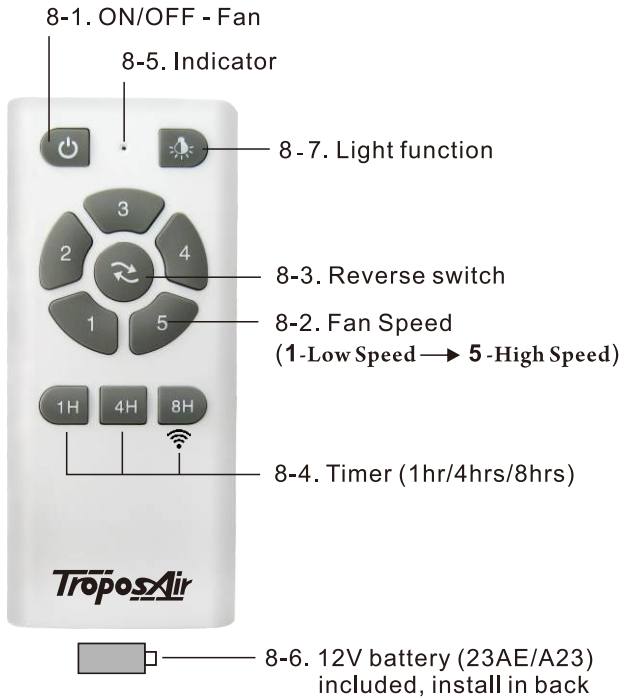

All the button pressed will have a Beep sound and the red indicator light will turn on.

8-1. Press button to turn the fan ON/OFF.

Warning: DO NOT PRESS THE BUTTON FOR MORE THAN 4 SECONDS TO AVOID FACTORY RESET AND THE LOSS OF PRE-PAIRED PROGRAMING OF RECEIVER AND TRANSMITTER!

Note: On every startup, the fan will move forward & backward for 2~3 seconds.

8-2. Fan Speed: 1-Low Speed → 5-High Speed

8-3. Reverse switch

8-4. Timer (1hr/4hrs/8hrs)

8-5. Indicator

8-6. 12V battery (23AE/A23) included, install in back

8-7. Light On/Off/Dimmer (#630 sold separately)
Short press for Light ON/OFF
Hold the button for dimming the light

NOTE: Make sure the DIP switch is on dimming position. (See 7-2 in Page 6)

Note: The remote retains the last settings (fan speed and light dimming level) in memory. When turn on again, the fan will be on the same speed, and the light will be at the same brightness.

OPTIONAL LIGHT AVAILABLE

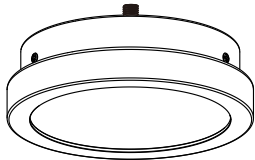

#630 Light Kit (sold separately)
Integrated type:
For only Solara / Troposair

TROUBLESHOOTING

In the event the fan does not operate properly, please perform the following steps.

8-8. Lower the canopy and check that all wires are connected properly.

8-9. Perform the remote Pairing Process at step 9-1 on P8.

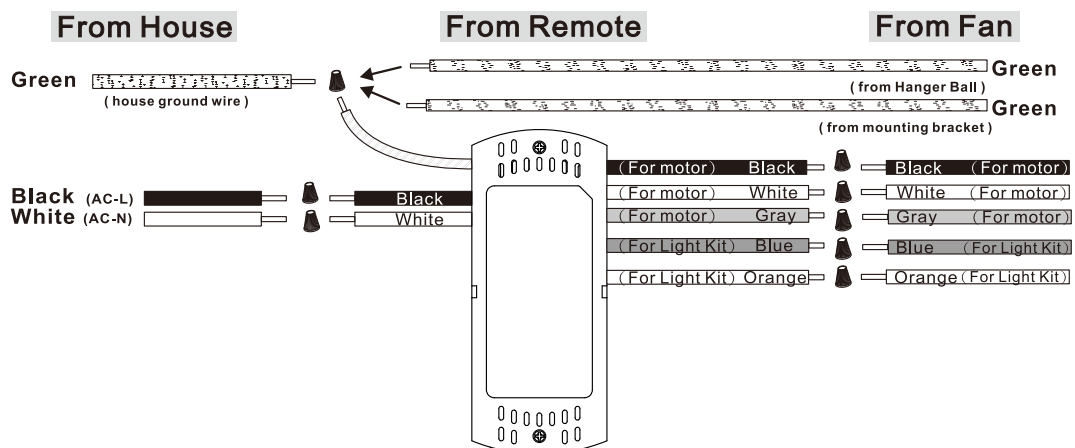

9 . REMOTE PAIRING PROCESS

The Pairing Process is only necessary when there is an issue. Remote set is pre-paired from the factory and should not require the Pairing Process.

A fan may need to have “Pairing Process” performed for the following issues.

1. Replacing the transmitter.
2. Replacing the receiver.
3. Multiple fans on the same circuit.

(In multiple fans situation, each fan must be wired up individually for the Pairing Process; **see step 9-1.**)

9-1. Pairing Process for transmitter and receiver:

1. Switch off the main power  and make sure fan has completely stopped .
2. Install a New receiver or install the battery in a new transmitter before the Pairing Process.
3. Switch on the power again, and immediately:

Press and hold the  button for 8 seconds until the Receiver “Long Beeps”.

This process must be done within 20 seconds after switching on the power.

This fan has completed the pairing successfully and the fan is ready for operation!

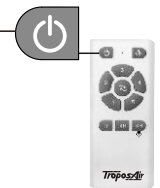

9-2A. Pairing Process for Multiple fans (One transmitter for multiple receivers)

If you wish to use only **one transmitter for two fans**, simply wire up both fans at one time and perform the Pairing Process at **step 9-1** from a point between the two fans.

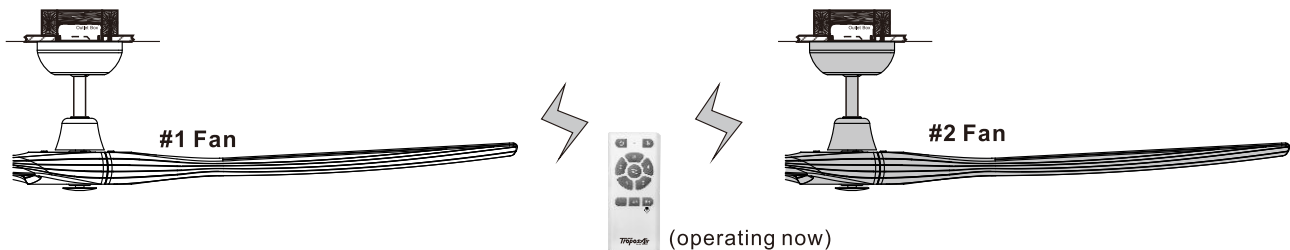

9-2B. Pairing Process for Multiple fans (One transmitter for one receiver)

The Pairing Process must be performed on each remote set (transmitter and receiver) individually. See the set up at step 9-3.

9 - 3. TO SET UP REMOTE FOR #1 FAN

Make sure to turn off power at breaker box. 
Disconnecting wire from #2 fan.

Before starting the remote control setting process, lower the canopy of #2 Fan and disconnect the Black wire. Put the wire nut on the black wire from the house

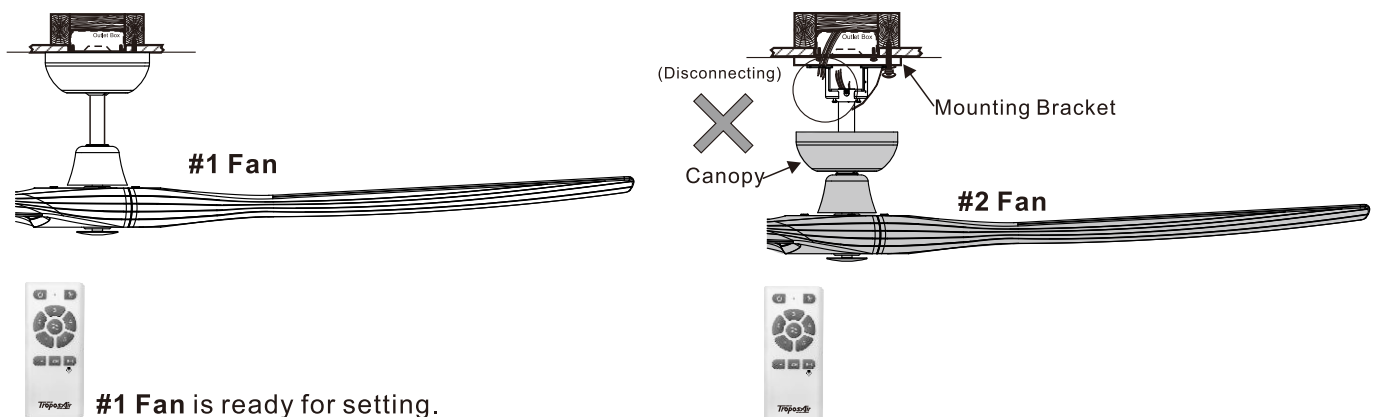

Turn on power at breaker box and #1 Fan is ready for pairing. 

*See the remote control setting process 9-1 to set up #1 Fan.

9-4. TO SET UP REMOTE FOR #2 FAN

Make sure to turn off power at breaker box. 

Disconnecting wire from #1 Fan

Disconnect the Black wires from #1 Fans and connect the Black wires back to #2 Fan that you remove from 9-3.

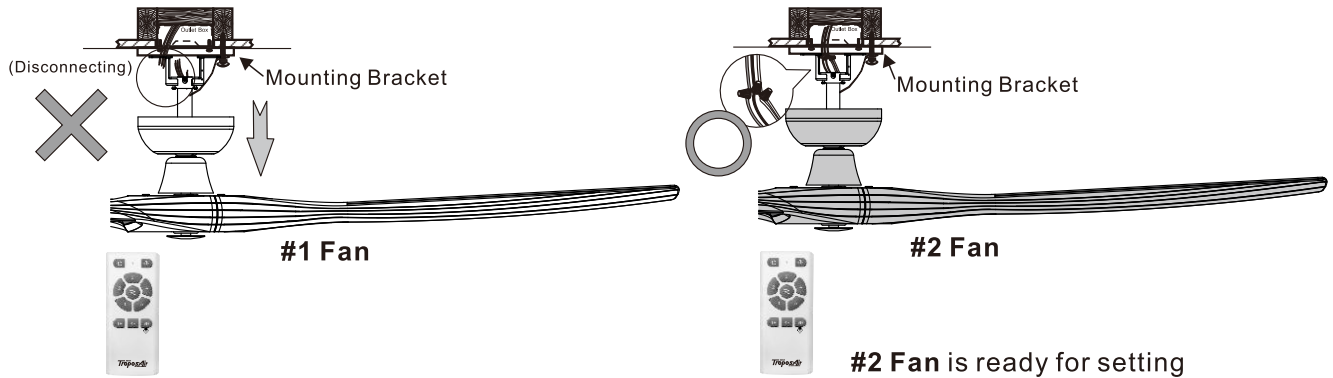

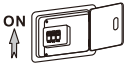
Turn on power at breaker box and #2 Fan is ready for setting. 

*See the remote control setting process for 9-1 to set up #2 Fan.

9-5. RECONNECT ALL FANS

Make sure to turn off power at breaker box. 

After all the fans have done the resetting process, reconnect all the wires for #1 fan & #2 fan, and lift up the Canopy of #1 fan & #2 fan.

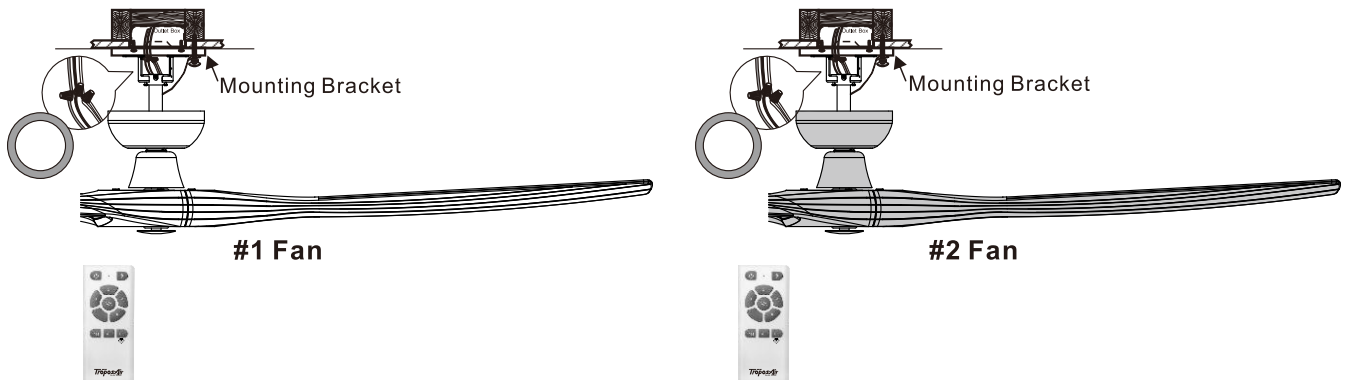

9-6. Switch on the main power and now each of these two fans are operated by its own remote individually.

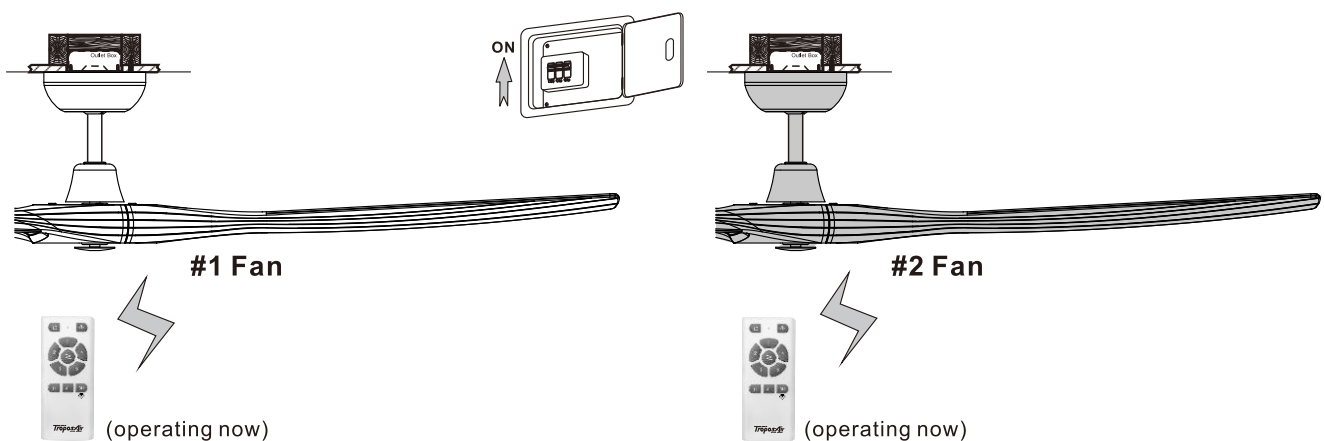

NOTE: For more than two fans, the same rules apply. Make sure only one fan at a time is connected to power when doing the Remote Setting. Already completed fans should be disconnected until all fans have completed the Remote Setting process.

10. WIFI PAIRING

A. Installation

You can scan the QR code below to download the **Smart Life** app.

You can also search “**Smart Life**” in major application markets to install the app.



B. Register an account and log in.

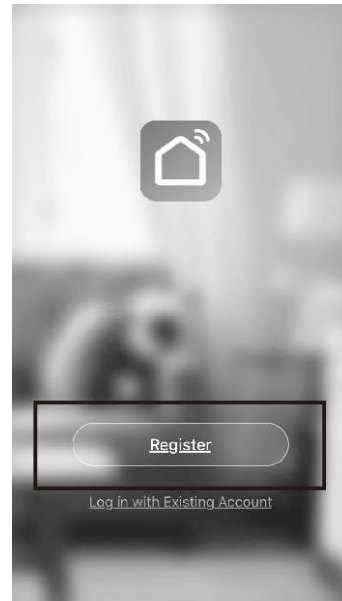

C. WiFi Connect

NOTE: You must turn on the "Location Services" before WiFi pairing.

1. First ensure that WiFi can be used normally.
2. Click “**Add Device**”, first select “**Small Home Appliance**”, then select “**Fan**”.

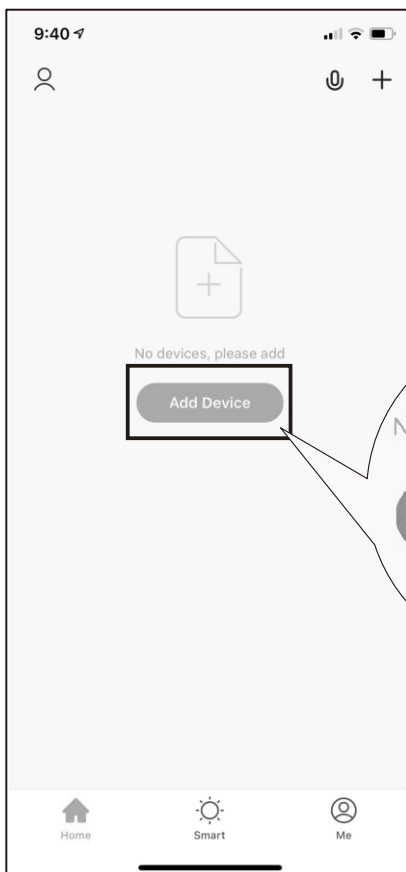

Small Home Appliance



3. Press and hold the “8H” button of the transmitter for more than 5 seconds. Wait until the ceiling fan receiver emits “BeeBee” continuously.



4. Select the correct WiFi source, then enter the WiFi password and click “Confirm” to wait while “Connecting”.

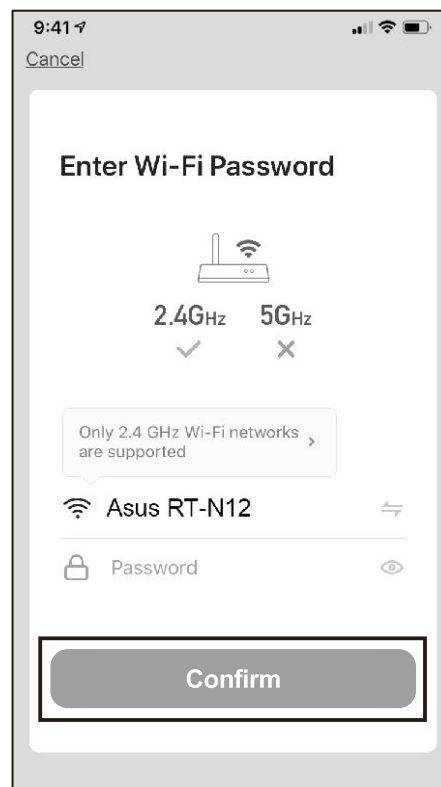
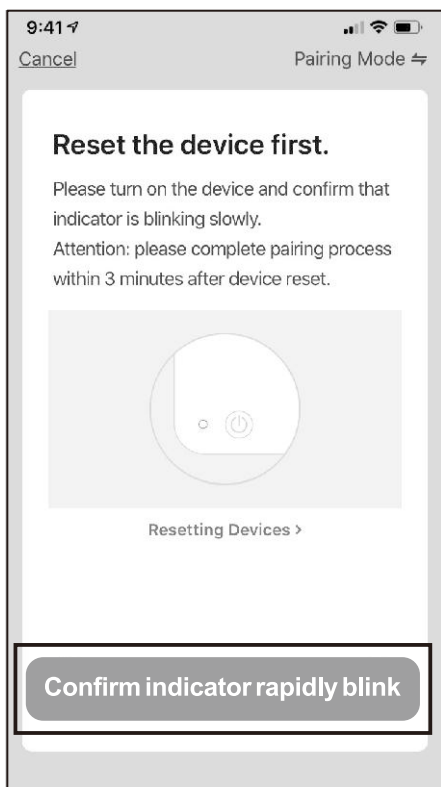

5. Wait for a successful connection.

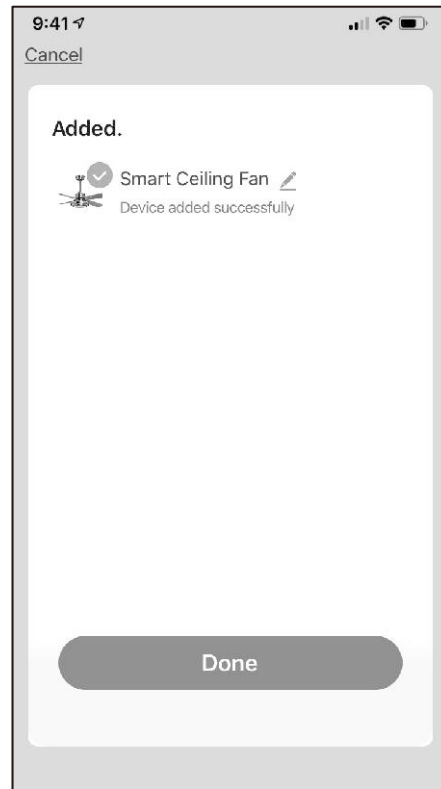
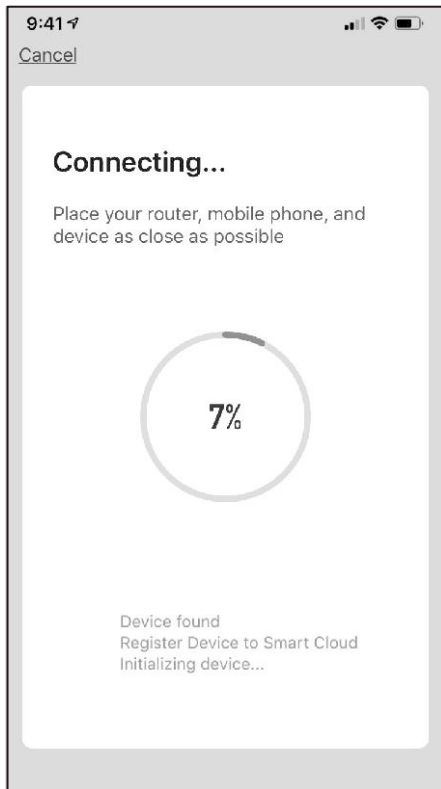

NOTE: If WiFi Pairing failed, please follow below instruction.

1. Press and hold the “4H” button of the transmitter for more than 5 seconds. Wait until the ceiling fan receiver emits “BeeBee” continuously.



2. Select Pairing Mode “AP Mode” on mobile device.

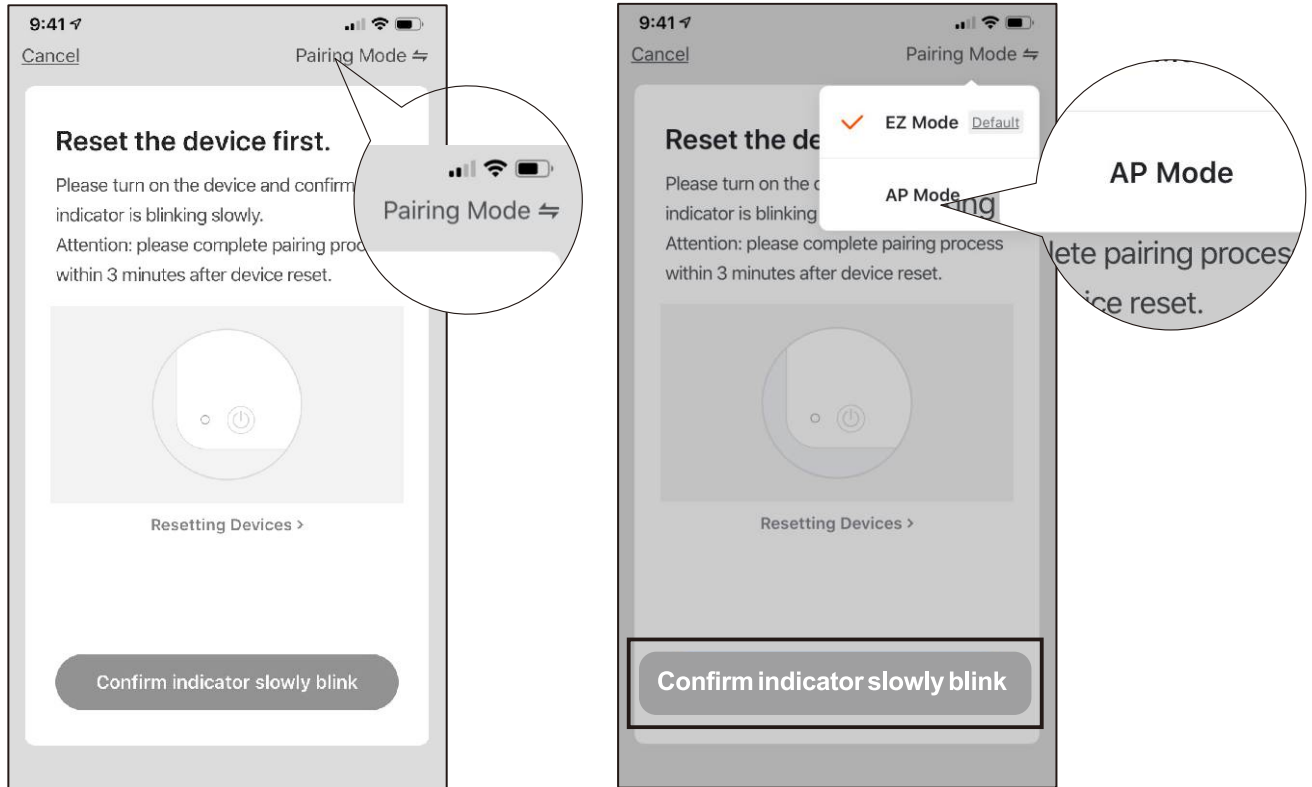

3. Select the correct WiFi source, then enter the WiFi password and click “Confirm” to wait while “Connecting”.

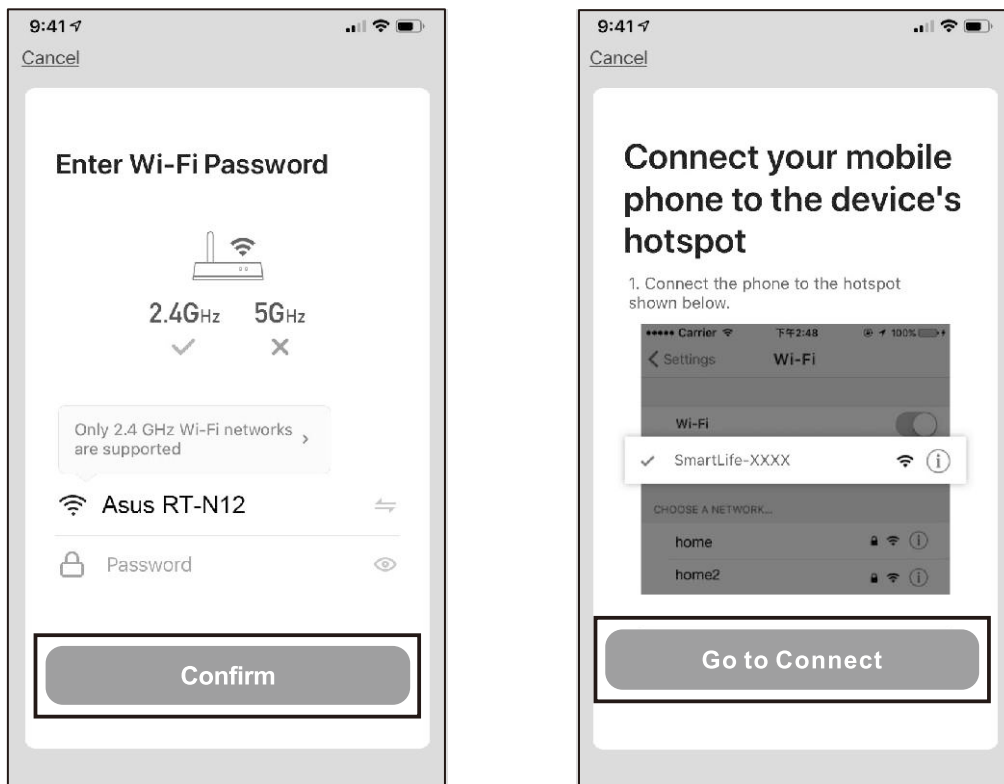

4. Wait for a successful connection.

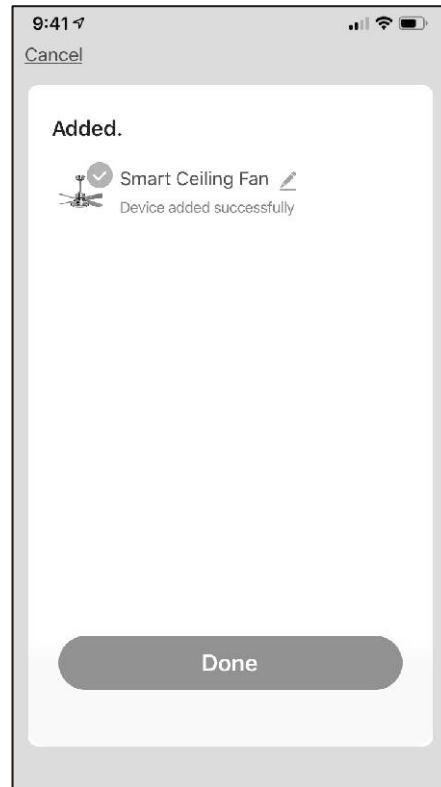
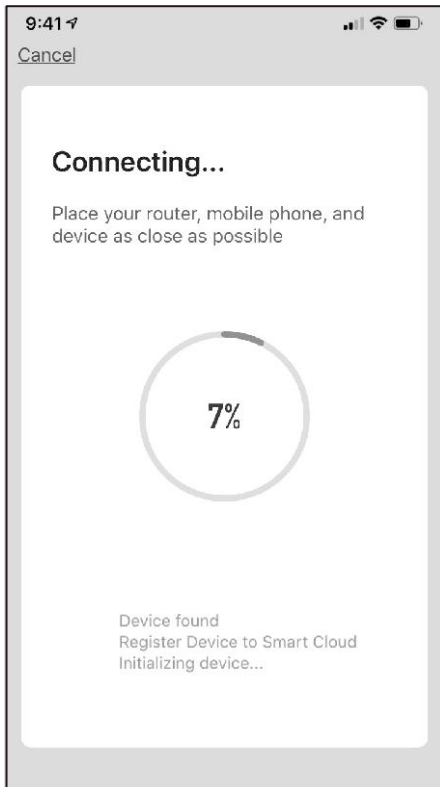

D. Multiple Users

1. In the App's Main Control Panel, click the “” in the upper right corner for more functions.
2. Click “Share Device”, “Add Sharing”.

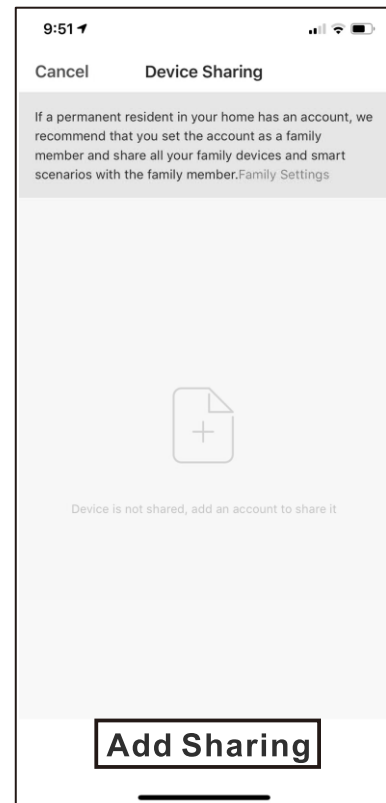
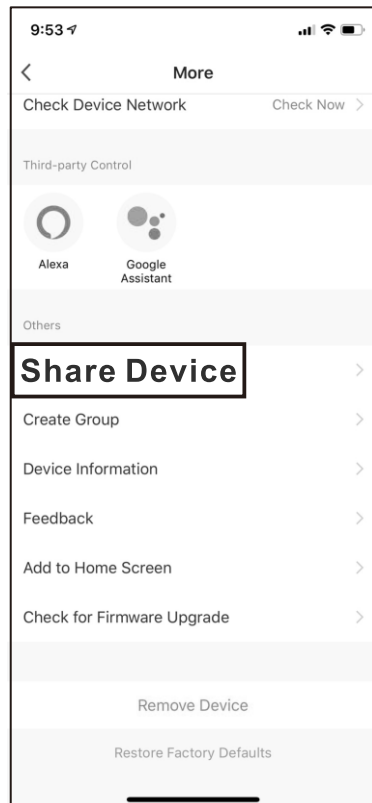
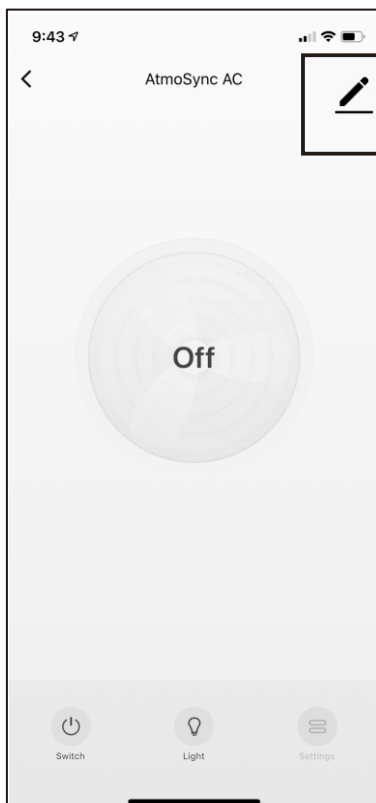

3. Enter the phone number of another Smart Life user, and click **“Completed”** to share.
Hint: The simplest way to share multiple devices with multiple users is to log in as a public account.

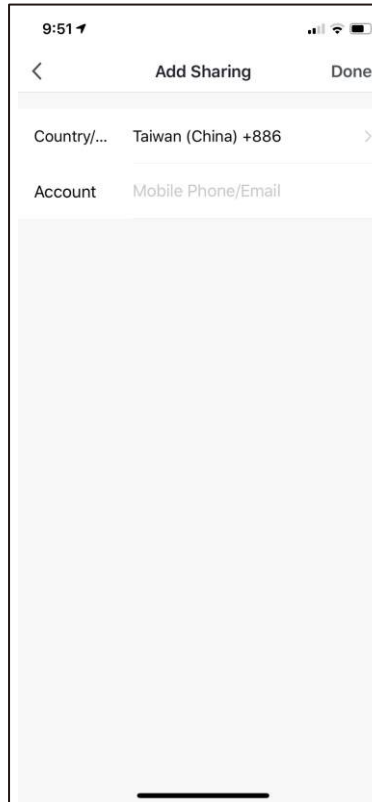

NOTE: This method requires the other users have the “Smart Life” app installed.

E. For more information, go to the “Me” - “FAQ & Feedback” in the app to learn.

