



Funny four-word game chess



Congratulations on your purchase!
We truly value your happiness with your new Giantville product.



Questions or concerns with our order?

Contact us for immediate assistance:



Call or text us
(833)456-9462



Email us
support@joyin.co





WARNING:

CHOKING HAZARD: Small parts.

Not for children under 3 years.



WARNING: This toy is to be assembled by an adult. Contains potentially hazardous sharp edges and sharp point, or contains small parts before the assembling.



ADVERTENCIA:

PEUDE CAUSAR ASFIXIA - Juguete no recomendado para menores de 3 años. Contiene bordes cortantes y puntas punzantes potencialmente peligrosas o contiene pequeñas piezas antes del montaje.



ADVERTENCIA: Este juguete debe ser montado por un adulto. Contiene bordes cortantes y punzantes potencialmente peligrosos o contiene pequeñas piezas antes del montaje.



ATTENTION:

NE CONVIENT PAS - Aux enfants de moins de 36 mois.

Petits éléments détachables susceptibles d'être avalés.



AVERTISSEMENT: Ce jouet doit être assemblé par un adulte. Contient des bords tranchants potentiellement dangereux et des pièces pointues, ou contient des petites Pièces avant l'assemblage.



AVISO:

PERIGO DE BLOQUEIO - Peças pequenas.

Não recomendado a menores de 3 anos.



AVISO: este brinquedo deve ser montado apenas por um adulto. Contém peças potencialmente perigosas como bordas, pontas afiadas e peças de dimensão reduzida prévias à montagem.

GAINT 4-IN-A-ROW

ASSEMBLY INSTRUCTIONS

Step 1:

Bring body pieces together in a standing position

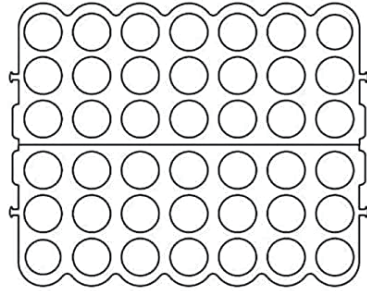

Step 2:

Connect one side by sliding into place.

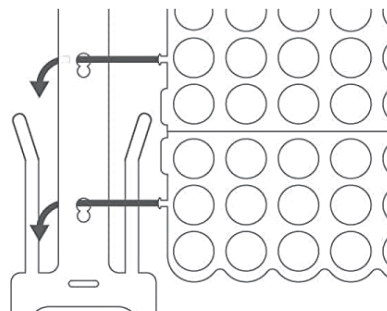

Step 3:

Flip over, repeat with other side.

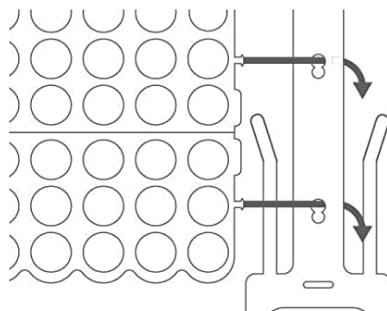

Step 4:

Turn upright. Forcefully, insert sliders into slots near base of sides until it clicks in place.

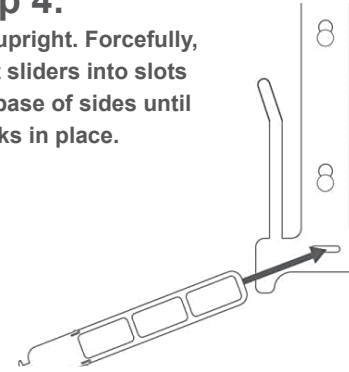

Step 5:

Put donuts on pegs.

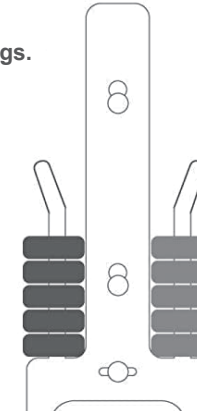

Step 6:

Beat all your friends.



PARTS INCLUDED:



X21



X21

WARNING: Assembly, maintenance or dismantling must be undertaken by an adult. Use for intended purpose only.

GAINT 4-IN-A-ROW

HOW TO PLAY

GAME ON!

One player/team gets all the blue coins, the other player/team gets all the red coins. Decide which player/team goes first. Take turns dropping coins into the grid board until one player/team gets four coins of their color in a row. The four in a row can be horizontal, vertical, or diagonal. See examples in the next section.

WINNER!

Get 4 coins in a row FIRST!

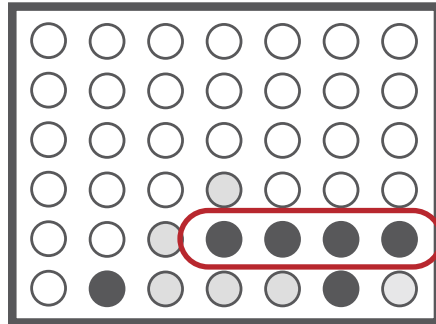

HORIZONTAL

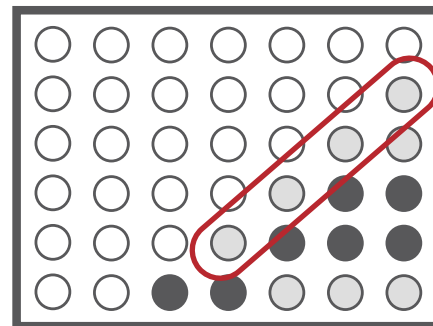

DIAGNAL

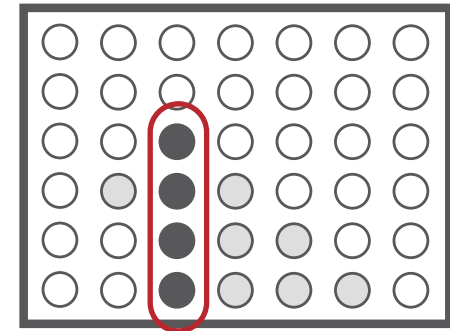

VERTICAL