

NEU560 series

Upright vacuum cleaner; household type

Owner's Guide

Thank you for purchasing your new Eureka vacuum!

Important instructions

For easy assembly, please take a few moments to read this owner's guide.

Do not return to the store. Call
Eureka Customer Service HELPLINE
1-800-282-2886. *We're here to help!*



Eureka stands by our Clean Promise seal.
Learn more at www.eureka.com/cleanpromise

www.eureka.com



eureka®

Where to find important vacuum information

Keep this information

Write the model, type and serial number here:

Date of purchase (keep your receipt) _____

Model number and type _____

Serial number _____

Find these numbers on a label on the bottom of the vacuum cleaner. Refer to these numbers when ordering parts and accessories, or if service is needed.

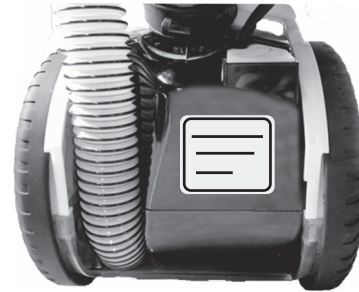

This Owner's Guide provides important instructions to prolong the life of your Eureka vacuum cleaner.

Registration : To register your product visit www.eureka.com and click on the 'Register Your Product' link in the top right corner.

Inspection : Carefully unpack and inspect your new Eureka vacuum cleaner for shipping damage. Each unit is tested and thoroughly inspected before shipping. For instructions regarding any shipping damage, call Eureka Customer Service HELPLINE 1-800-282-2886 immediately.

Contents

Important safeguards	3
What comes in the carton	4
How to assemble your vacuum cleaner	5
How to identify parts of your vacuum cleaner	6
How to use your vacuum cleaner	7
How to use accessory tools	8-9
How to maintain dust cup and filters	10-11
How to maintain brushroll	12
How to clear a blockage	13
How to maintain pet turbo brush	14
Thermal cut-off and problem solving	14
The Eureka limited warranty	15
How to order replacement parts	16

 Follow caution information wherever you see this symbol.

IMPORTANT SAFEGUARDS

When using an electrical appliance, basic precautions should always be followed, including the following:

READ ALL INSTRUCTIONS BEFORE USING THIS VACUUM CLEANER

WARNING



To reduce the risk of fire, electric shock, or injury:

- Do not use outdoors or on wet surfaces.
- **Do not leave vacuum cleaner when plugged in.** Turn off the switch and unplug the electrical cord when not in use and before servicing.
- Do not allow to be used as a toy. Close attention is necessary when used by or near children.
- Use only as described in this manual. Use only manufacturer's recommended attachments.
- Do not use with damaged cord or plug. If vacuum cleaner is not working as it should, has been dropped, damaged, left outdoors, or dropped into water, return it to an authorized service center before using.
- Do not pull or carry by cord. Do not use cord as a handle. Do not close a door on cord or pull cord around sharp edges or corners. Do not run vacuum cleaner over cord. Keep cord away from heated surfaces.
- Do not use extension cords or outlets with inadequate current carrying capacity.
- Turn off all controls before unplugging.
- Do not unplug by pulling on cord. To unplug, grasp the plug, not the cord.
- Do not handle plug or vacuum cleaner with wet hands.
- Do not put any objects into openings. Do not use with any openings blocked; keep free of dust, lint, hair, and anything that may reduce airflow.
- This vacuum cleaner creates suction and contains a revolving brushroll. Keep hair, loose clothing, fingers, and all parts of body away from openings and moving parts.
- Do not place vacuum cleaner on furniture or stairs as the brush roll may cause damage. Use extra care when cleaning stairs. Place vacuum cleaner on floor with the handle in storage position while using attachments.
- Do not pick up anything that is burning or smoking, such as cigarettes, matches, or hot ashes.
- Do not use without dust cup, filter, screen and exhaust filter in place.
- Belt pulleys can become hot during normal use. To prevent burns, avoid touching the belt pulley when servicing the drive belt.
- Do not use to pick up flammable or combustible liquids such as gasoline, or use in areas where they may be present.
- Store your vacuum cleaner indoors in a cool, dry area.
- Keep your work area well lighted.
- Unplug electrical appliances before vacuuming them.
- Unplug before connecting pet turbo brush.
- **WARNING:** This product contains chemicals known to the State of California to cause cancer, birth defects or reproductive harm. WASH HANDS AFTER HANDLING.

SAVE THESE INSTRUCTIONS

To reduce the risk of electric shock, this appliance has a polarized plug (one blade is wider than the other). This plug will fit in a polarized outlet only one way. If the plug does not fit fully into the outlet, reverse the plug. If it still does not fit, contact a qualified electrician to install the proper outlet. Do not change the plug in any way.



Motor

Do Not Oil the motor or the brush roll at any time. The bearings are permanently lubricated and sealed.

What comes in the carton

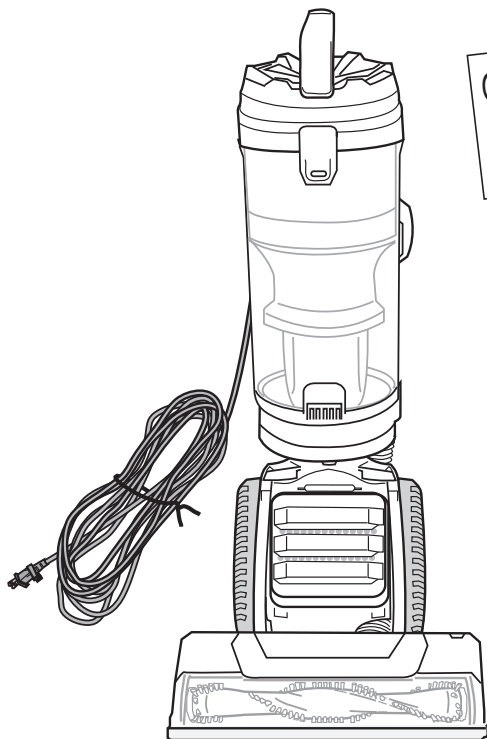

Vacuum cleaner with dust cup



Important safeguards



Flexible telescoping crevice tool with brush (on back side of vacuum)

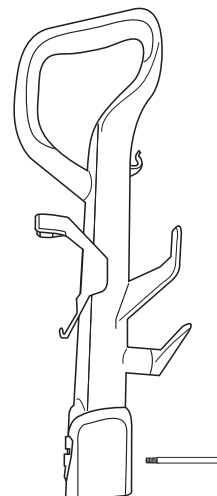

Handle with screw

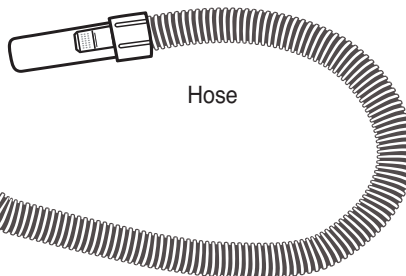

Hose

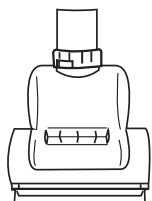

Pet turbo brush

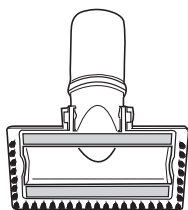

2-in-1 upholstery tool

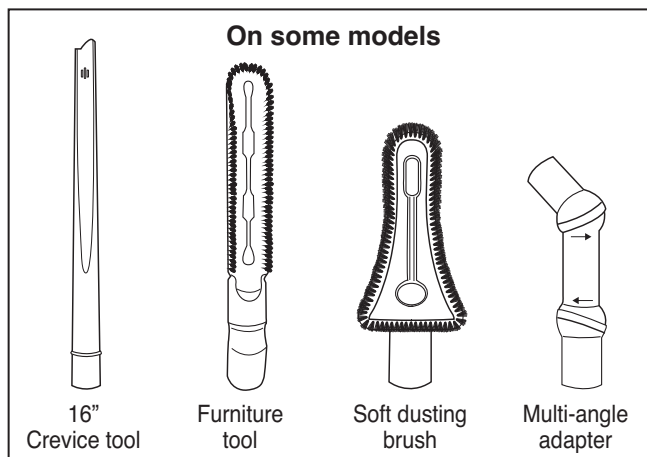

On some models

16" Crevice tool

Furniture tool

Soft dusting brush

Multi-angle adapter

How to assemble your vacuum cleaner

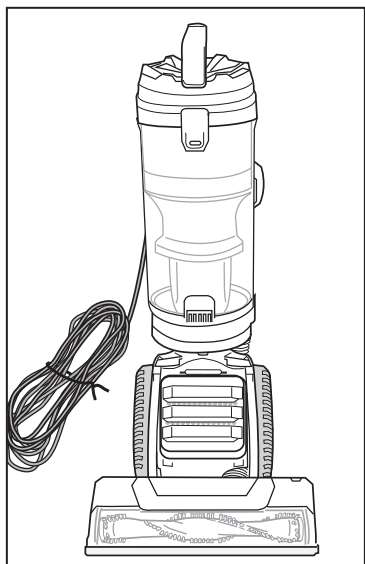

Vacuum cleaner with dust cup.

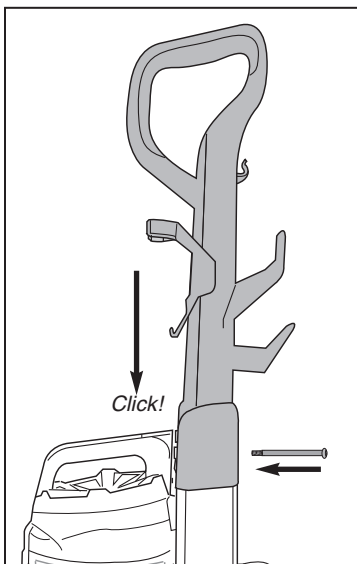

Slide handle onto top of vacuum cleaner. Push down until it clicks. Secure with screw.

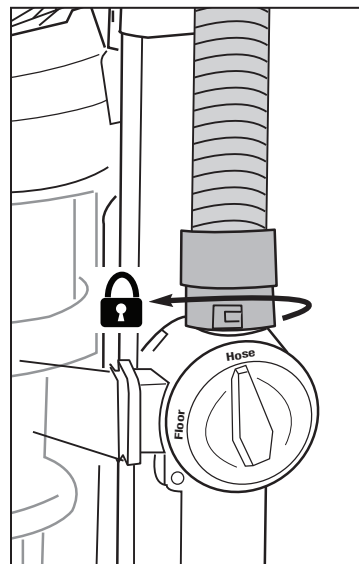

Attach hose. Align tab with slot and push down; twist clockwise to lock.

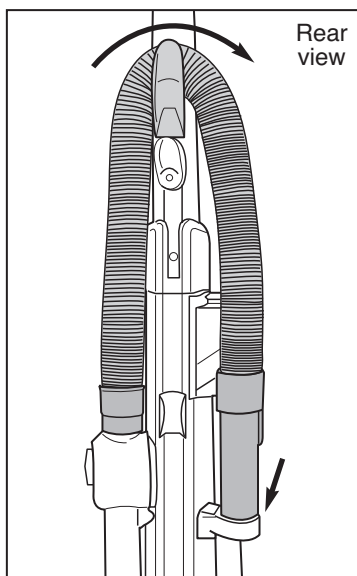

Loop hose over hose retainer and secure loose end onto post.

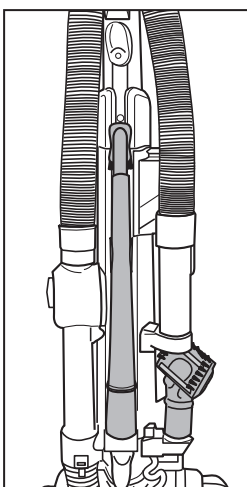

Store 2-in-1 upholstery tool on lower post. Snap telescoping crevice tool with brush into center clip.

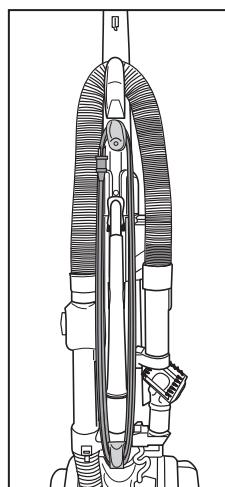

Wrap cord onto upper and lower cord wrap.

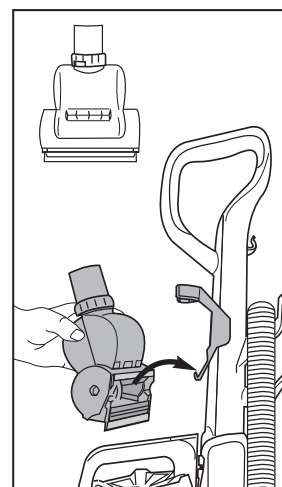

Store pet turbo brush on front of handle. Align brush opening with slot and push to snap tool into clip.

How to identify parts of your vacuum cleaner

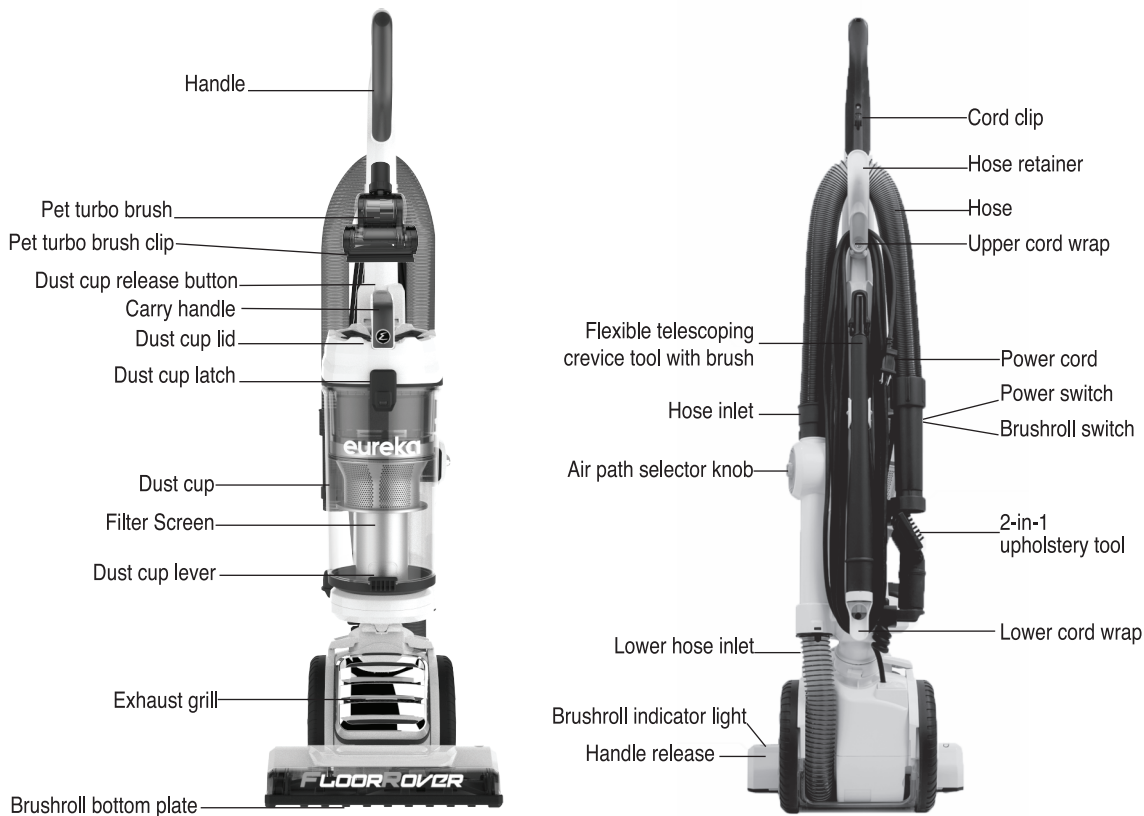

For filter maintenance instructions, see pages 10 and 11

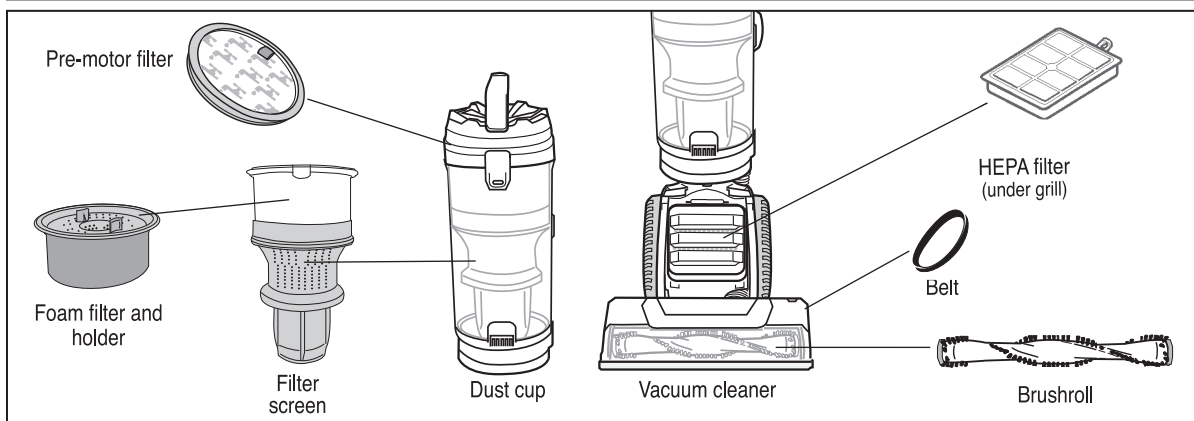

How to use your vacuum cleaner

CAUTION

Be sure brushroll is turned OFF when vacuuming hard-surface floors.

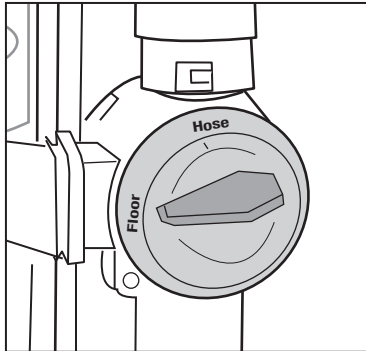

Plug power cord into outlet. To vacuum floors, turn air path selector knob to 'FLOOR.'

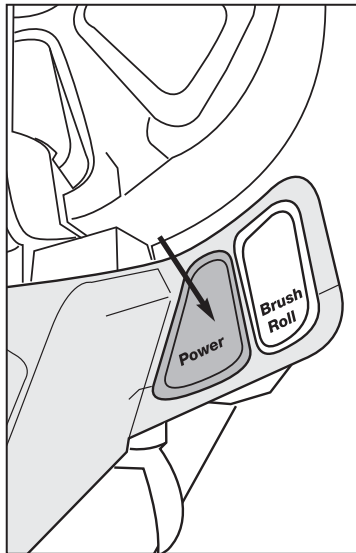

Press power switch to turn on.

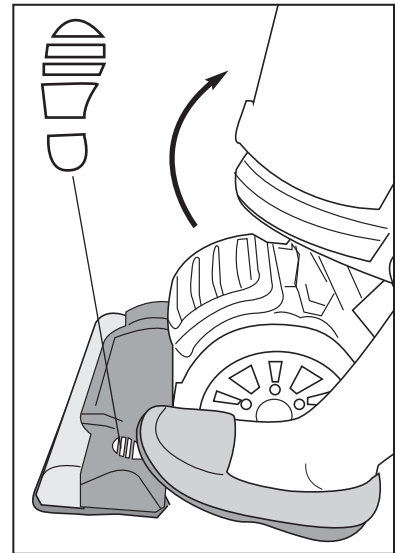

Step on handle release to lower handle into position for vacuuming floors.

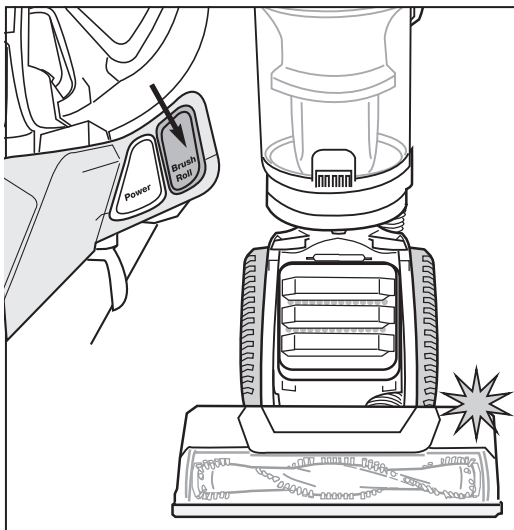

To vacuum carpet, press brushroll switch to turn on brushroll. Indicator light will turn blue when brushroll is on. Brushroll will operate only when handle is lowered into position for vacuuming.

Empty dust cup after every use

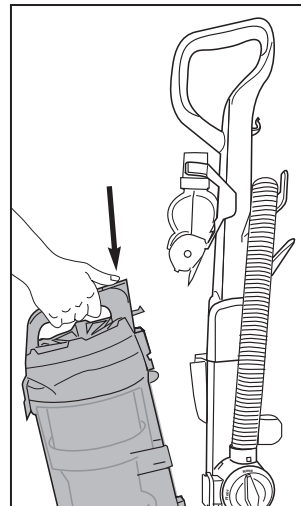

Press release button and lift off dust cup.

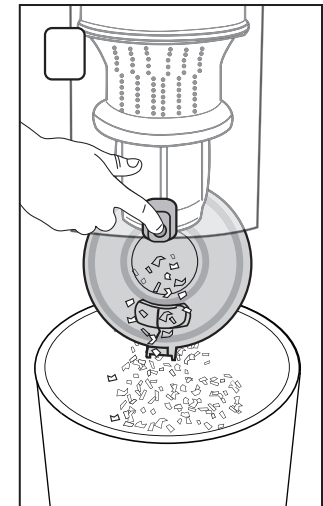

To empty debris, press lever to release bottom lid.

How to use accessory tools

CAUTION

When using tools, always place vacuum cleaner in upright position and turn off brushroll. Make sure vacuum cleaner is turned off while attaching tools.

- Place vacuum in upright position. Turn air path selector knob to 'HOSE.'

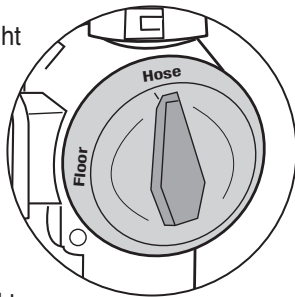

- Lift hose end off post and firmly insert desired tool to attach.
- Use slide on hose end to adjust suction power.
- When finished using tools, reposition hose over retainer and secure loose end on post. Store tools on vacuum cleaner.

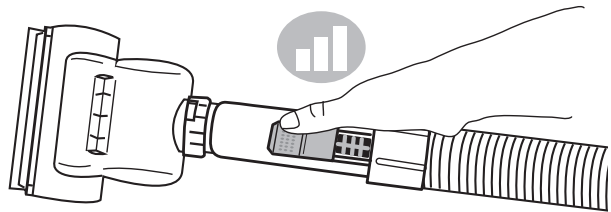
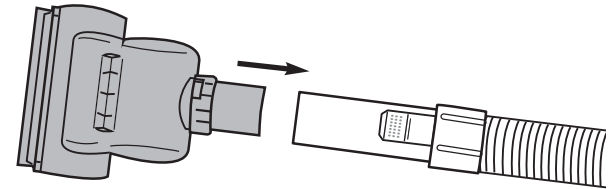

Pet turbo brush: Use to easily remove pet hair from stairs, carpet or upholstery. Adjust angle of front nozzle to suit different surfaces.

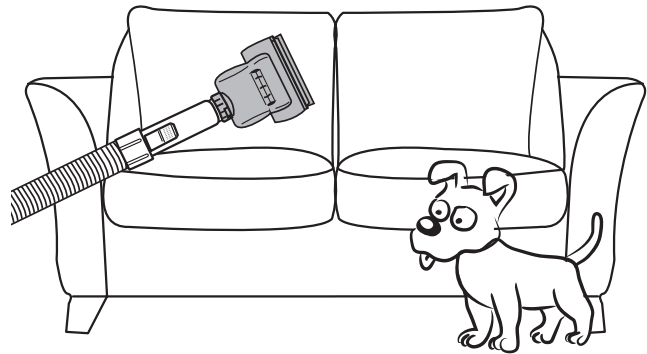

2-in-1 upholstery tool: Use brush to vacuum upholstered surfaces or pick up debris. Use felt portion to clean delicate surfaces. Press thumb release and lift brush up and out of the way.

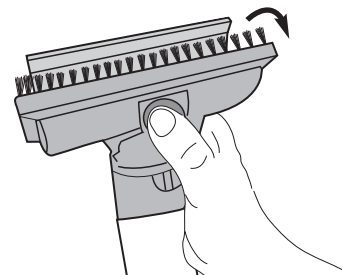
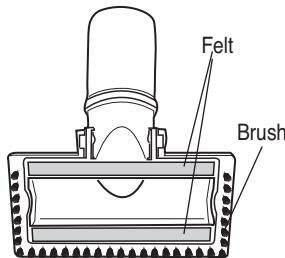

How to use accessory tools

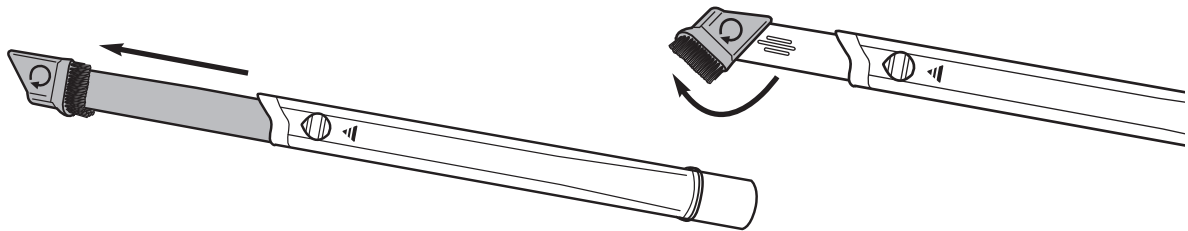

Flexible telescoping crevice tool with brush: Press button and pull to extend tool to desired length. To use brush, pull to swivel into position. Use for baseboards, crevices and tight spaces.

Additional tools (some models)

Included tools will vary depending on model purchased. To order additional tools, see page 16.

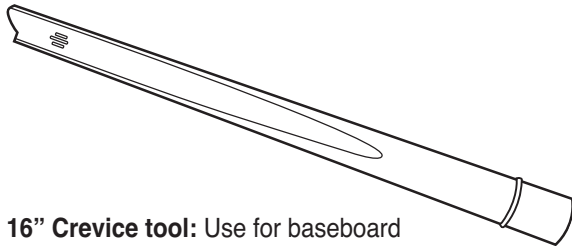

16" Crevice tool: Use for baseboard edges, corners, detailing chairs, sofas, dryer vents and tight spaces.

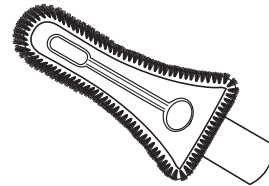

Soft dusting brush: Use for bookshelves, drapes, blinds, and vents.

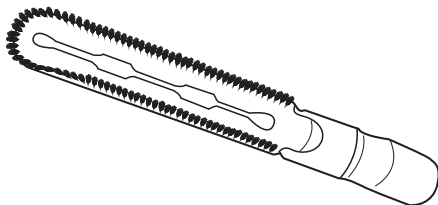

Furniture tool: Use for chairs, sofas, mattresses, and carpeted stairs.

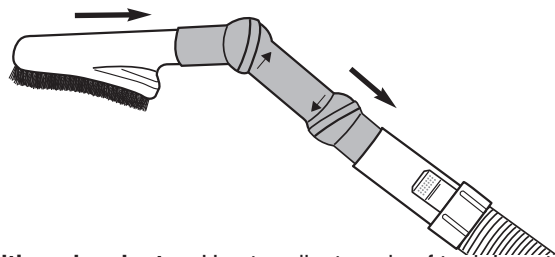

Multi-angle adapter: Use to adjust angle of tool. Insert adapter into hose end first, then insert tool. Twist adapter sections to adjust angle.

How to maintain dust cup and filters

Dust cup – Empty after each use

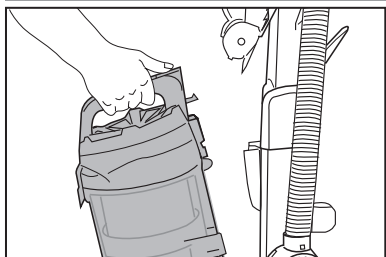

Press release button and lift off dust cup.

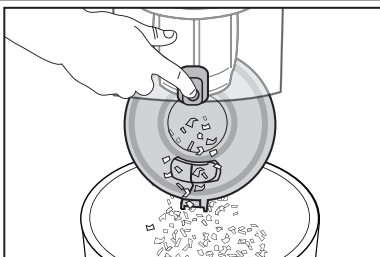

Hold dust cup over wastebasket and press lever to release bottom lid. Debris will empty.

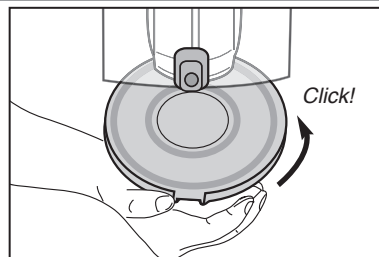

Close bottom lid until it clicks.

Washable dust cup filters – Clean frequently

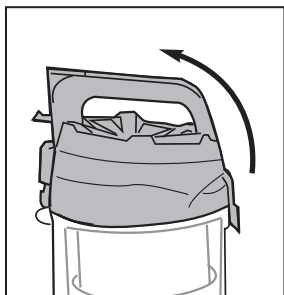

Pull dust cup latch to lift up dust cup lid.

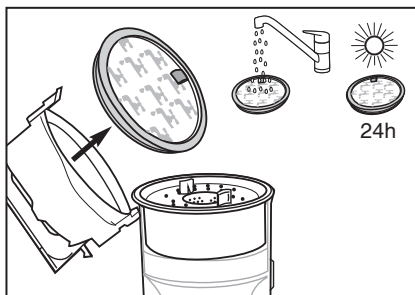

Lift out pre-motor filter and shake off dust frequently. Every three months, rinse filter and dry thoroughly.

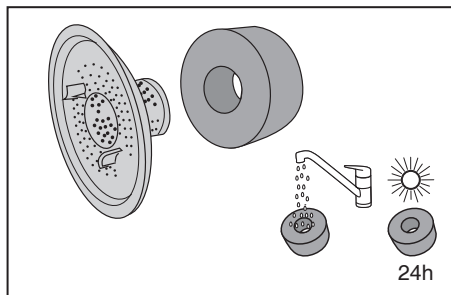

Lift out filter holder, pull off foam filter and shake off dust frequently. Every three months, rinse foam filter and dry thoroughly.

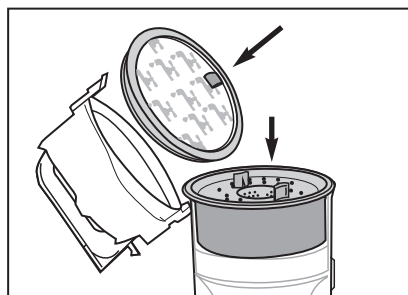

Reinstall foam filter, filter holder and pre-motor filter.

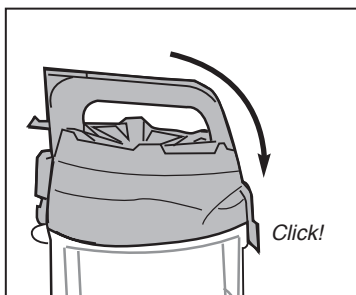

Close cover until it clicks.

How to replace HEPA filter

HEPA filter – Replace every year



Caution: Make sure vacuum cleaner is turned off and power cord is unplugged.

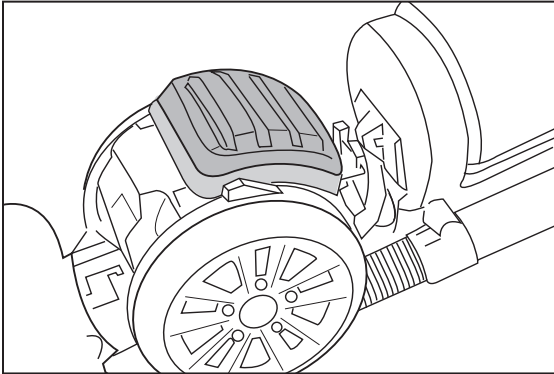

Step on handle release and lay cleaner flat for easy access to HEPA filter.

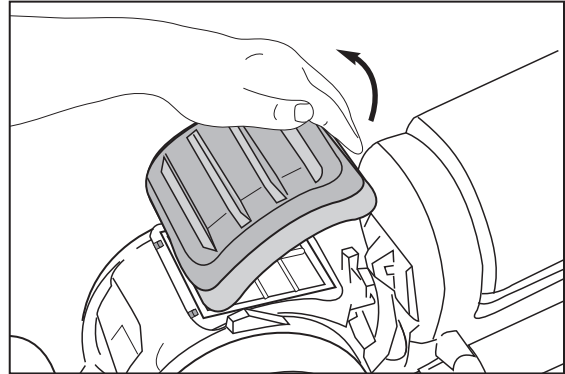

Press lever and lift off exhaust grill.

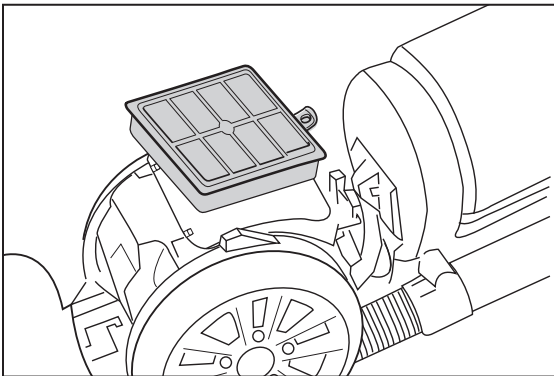

Grasp tab and lift out HEPA filter. Install new HEPA filter. **Note:** All filters are washable and can be cleaned by rinsing with warm water. Be sure the filter is completely dry before installing.

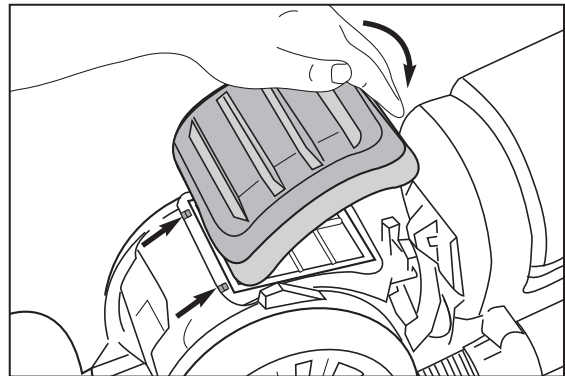

Insert front edge of grill between two tabs; press to close.



Warning: Never operate vacuum cleaner without all filters, filter screen and dust cup in proper position.

How to maintain brushroll

To avoid unnecessary service calls, periodically check brushroll for debris.



CAUTION

Make sure vacuum cleaner is turned off and power cord is unplugged.

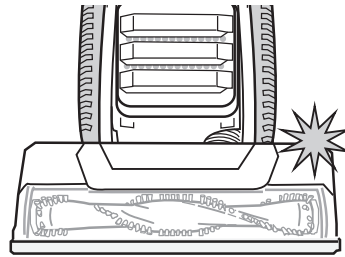

If brushroll light turns red, this indicates the brushroll is clogged and cannot turn. Brushroll will automatically shut off until clog is removed and vacuum is returned to upright position.

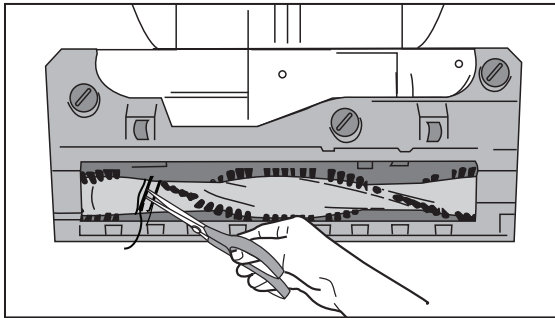

Step on handle release to lower handle. Turn vacuum face down on floor. Use scissors to clip heavy threads or strings.

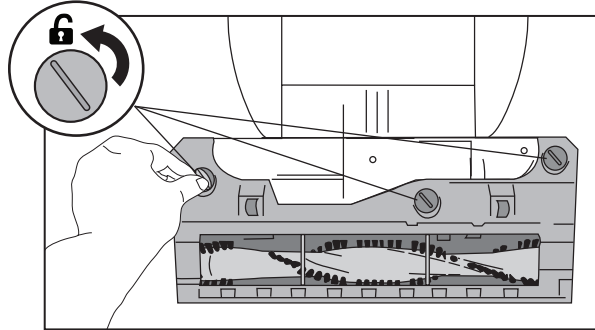

If debris cannot be removed easily, remove bottom plate for greater access to brushroll. Using flat-head screwdriver or coin, turn 3 slots counter-clockwise a quarter turn to 'unlock' position.

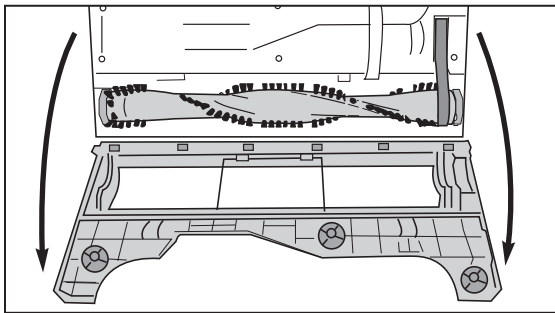

Grasp brushroll bottom plate at top and pull down to remove.

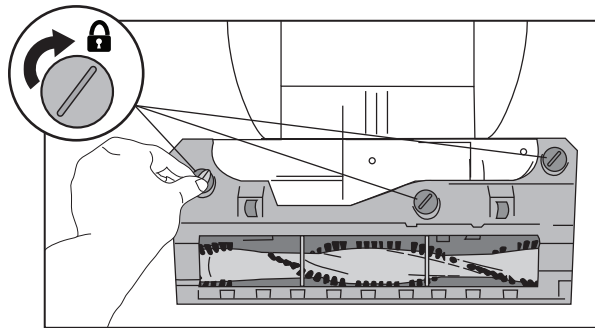

To replace bottom plate, align 6 tabs with slots and press each firmly to snap on. Use coin to turn slots clockwise to 'lock' position.

How to clear a blockage

CAUTION

Make sure vacuum is turned off and power cord is unplugged.

Warning: Never operate vacuum cleaner without all filters, filter screen and dust cup in proper position.

If vacuum is not cleaning carpet, or if no suction at end of hose, check to be sure air path is not blocked.

- Press release button and lift off dust cup (Fig. 1).
- Empty debris. Hold over wastebasket and press lever to release bottom lid (Fig. 2).
- Check filters and filter screen. Remove any debris and shake off dust. (See maintenance instructions on page 10.)
- Turn air path knob to 'FLOOR.' Use finger to check for debris in air path (Fig. 3).

If still no suction, check for blockage in hose.

- Remove hose from vacuum: Twist counterclockwise to loosen and lift off from air path knob (Fig. 4).
- Use a rod or similar blunt implement to clear any blockages in hose. Flex hose to loosen debris (Fig. 5). Use caution if there is any risk that glass or nails could have become imbedded in hose.
- Detach lower hose: Press tab to release; pull hose down. Use finger to clear blockage (Fig. 6).
- Reattach upper and lower hoses. Ensure that filters and dust cup are returned to proper position.

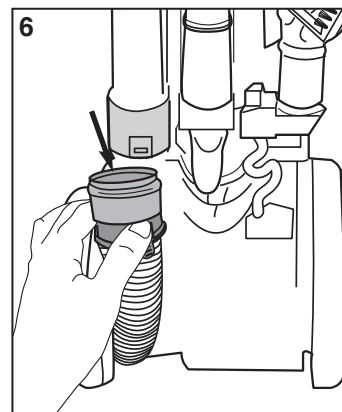
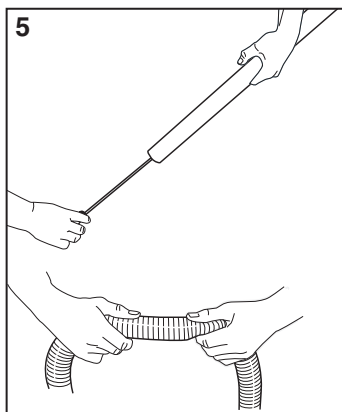
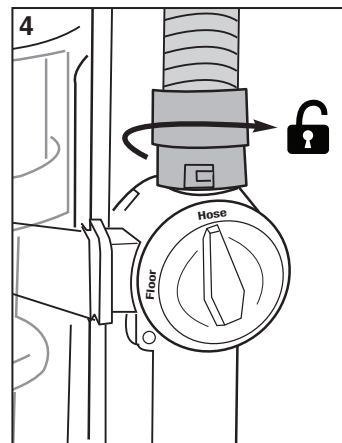
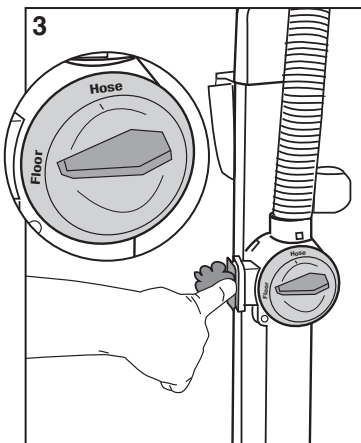
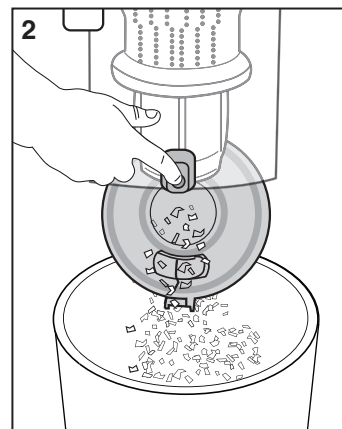
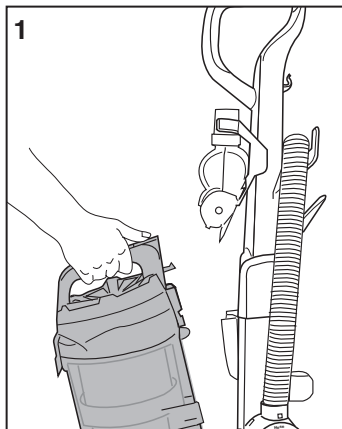

How to maintain pet turbo brush

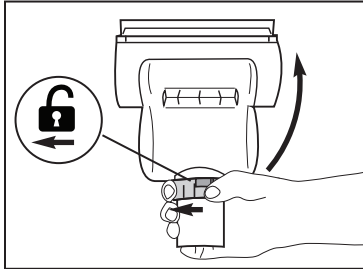

Grasp collar and twist to unlock cover. Lift cover up.

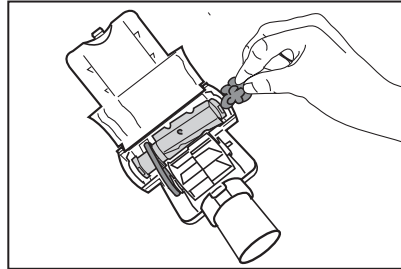

With cover open, use fingers or small brush to clear accumulated pet hair from turbo blades.

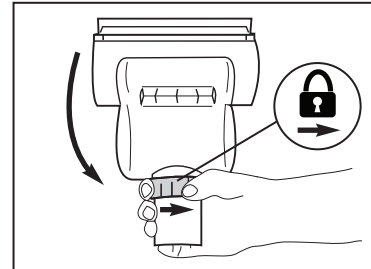

Close cover and twist collar to lock.

Problem solving

⚠ Make sure vacuum is turned off and power cord is unplugged.

NOTICE: Thermal cut-off

This vacuum cleaner has a special thermostat that protects the vacuum in case of motor overheating. **If the vacuum suddenly shuts off**, proceed as follows: 1) Push the power switch to off and unplug the vacuum. 2) Check the vacuum for a possible source of overheating such as a full dust cup, blocked hose or clogged filter. If these conditions are found, fix them and wait at least 30 minutes before attempting to use the vacuum. 3) After the **30 minute** period, plug the vacuum back in and turn on the switch. If the vacuum still does not work, call the Eureka customer service helpline.

Problem	Solution
Motor will not start.	<ul style="list-style-type: none"> • Push plug securely into outlet, try another outlet or check circuit breaker. • Press on power switch to turn vacuum on. • See detailed "thermal cut-off" instructions above.
Vacuum cleaner does not clean carpet or bare floor.	<ul style="list-style-type: none"> • Turn air path selector knob to 'FLOOR.' • Empty dust cup, clean and/or change filters regularly to maintain suction. • Indicator light will turn blue when brushroll is on. • Red indicator light indicates the brushroll is clogged. • Clean brushroll if needed.
No suction at the end of hose.	<ul style="list-style-type: none"> • Make sure air path selector knob is set to 'HOSE.' • See other solutions above. • Remove clogs from the hose that restrict the airflow.
Brushroll will not turn.	<ul style="list-style-type: none"> • Check brushroll for debris.
Pet turbo brush	<ul style="list-style-type: none"> • Check pet turbo brush for debris. • Make sure air path selector knob is set to 'HOSE.'

The Eureka limited warranty

Eureka warrants this vacuum cleaner to be free from defects in material and workmanship for a term of five years for normal household use. Warranty is granted only to the original purchaser and members of immediate household.

This warranty is good for five years from the date of purchase only when the vacuum cleaner is used in the accordance with Eureka operating instructions.

Note: refurbished or remanufactured products have a one year limited warranty.

This warranty does not cover

- Parts of the vacuum that require replacement under normal use such as disposable dust bags, filters, drive belts, light bulbs, brushroll, bristles, impellers and cleaning.
- Damages or malfunctions caused by negligence, abuse, and use not in accordance with the Owner's Guide.

What Eureka will do

Eureka will, at its option, repair or replace a defective vacuum or vacuum part that is covered by this warranty. As a matter of warranty policy, Eureka will not refund the consumer's purchase price.

Obtaining warranty service

To obtain warranty service you must return the vacuum or vacuum part along with "proof of purchase" to any Eureka Authorized Warranty Station. For Eureka Authorized Warranty Station or Service Information, visit www.eureka.com, write or telephone toll free:

1-800-282-2886

Midea America Corp.

5 Sylvan Way

Parsippany, NJ 07054

Obtaining warranty service outside your community

You must pay the shipping charges to the Eureka Authorized Warranty Station.

Return shipping charges will be paid by the Warranty Station. When returning parts for repair, please include the model, type and serial number located on the rating plate on the lower backside of the vacuum.

Further limitations and exclusions

Any warranty that may be implied in connection with your purchase or use of the vacuum, including any warranty of Merchantability or any warranty for Fitness For A Particular Purpose is limited to the duration of this warranty. Some states do not allow limitations on how long an implied warranty lasts, so the above limitations may not apply to you.













Your relief for the breach of this warranty is limited to the relief expressly provided above. In no event shall the manufacturer be liable for any consequential or incidental damages you may incur in connection with your purchase or use of the vacuum.

Some states do not allow the exclusion or limitation of incidental or consequential damages, so the above limitation or exclusion may not apply to you.

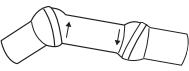
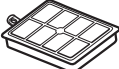
This warranty gives you specific legal rights. You may also have other rights, which may vary by state.

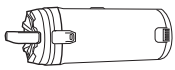
eureka®

Order genuine Eureka accessories and replacement parts
Visit www.eureka.com or call 1-800-282-2886

	Pet turbo brush	S3005
	Flexible telescoping crevice tool	S3006
	2-in-1 upholstery tool	S3007
	16" crevice tool	S3001
	Soft dusting brush	S3002
	Furniture tool	S3003
	Multi-angle adaptor	S3004
	HEPA filter	S3008
	Exhaust Grill	S3009
	Dust cup	S3010
	Pre-motor filter	S3011
	Foam filter	S3012
	Brushroll	S3013