

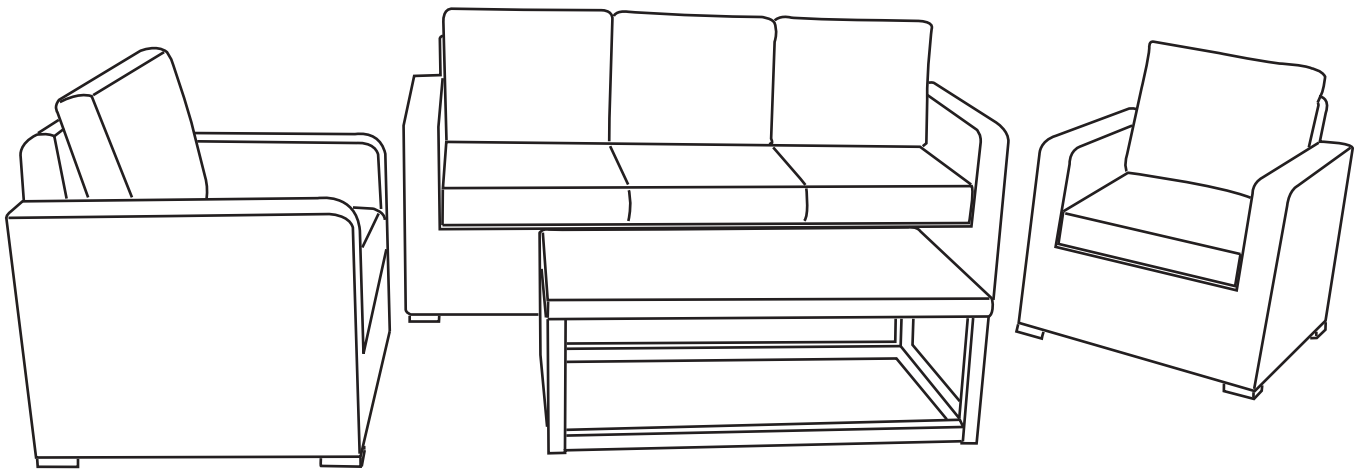

Item # 471082

FORSYTH SEATING ASSEMBLY INSTRUCTIONS



ATTACH YOUR RECEIPT HERE

Order Number _____ Purchase Date _____



Questions, problems, missing parts? Before returning to your retailer, email our customer service department directly at HELLO@LEISUREMADE.COM or call us at (888) 682-3012 8am-4pm EST, Monday-Friday.

PACKAGE CONTENTS

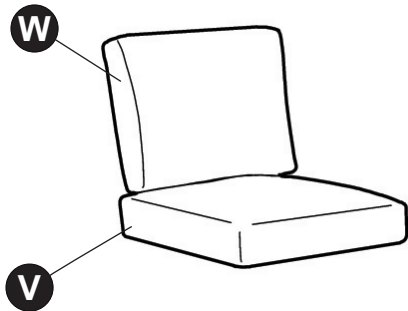
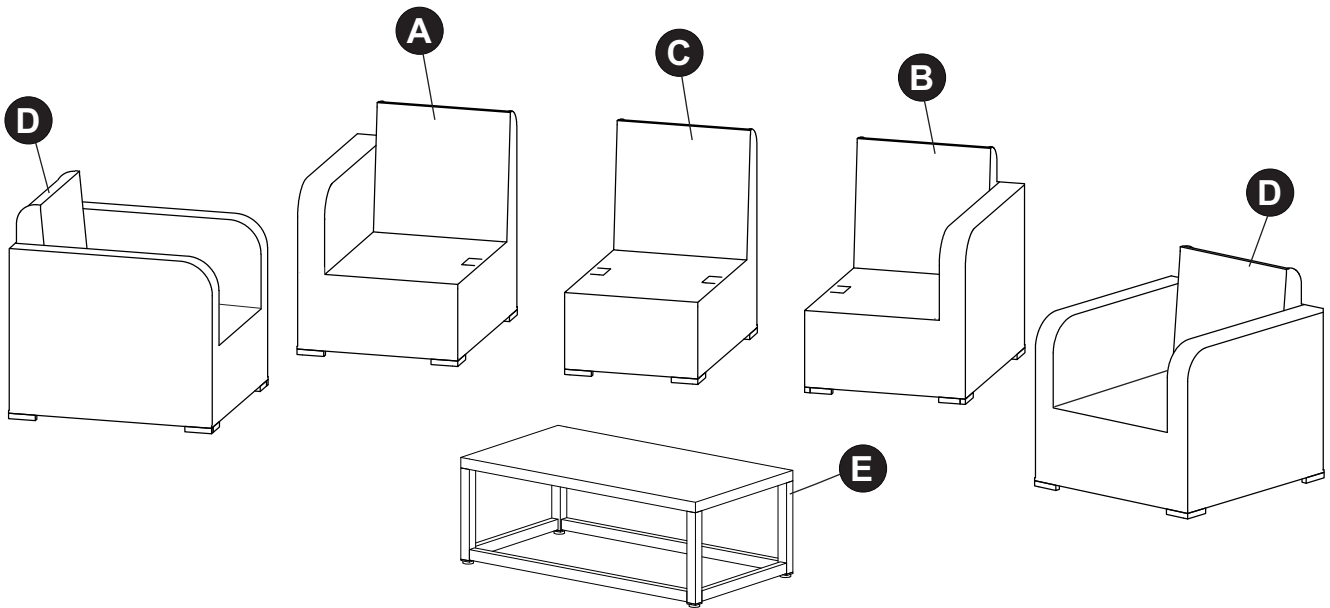

PART	DESCRIPTION	QTY
A	Right Arm Forsyth Seating	1
B	Left Arm Forsyth Seating	1
C	Armless Chair	1
D	ArmChair	2
E	Forsyth Coffee Table	1
V	Standard Seat Bottom	5
W	Standard Back Cushion	5

Note: You will also have 5 plastic bags containing your fabric.
 5 Bags: Standard Seat Covers (1 bag contains both 1 bottom seat and 1 back cover)

HARDWARE CONTENTS

EE

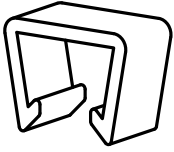

Chair Clips
Qty: 2

SAFETY INFORMATION

Please read and understand this entire manual before attempting to assemble, operate or install the product.

 **CAUTION:** Assemble on a soft, non-abrasive surface.

PREPARATION

Before beginning assembly of product, make sure all parts are present. Compare parts with the package contents list and hardware contents list. If any part is missing or damaged, do not attempt to assemble the product.

If you find a missing or damaged part, please look through all pieces to make sure nothing else is missing or damaged. Compile a comprehensive list and give us a call. We will send out all parts in a single shipment. Ensuring you have all missing parts identified at the time you call will ensure a faster delivery to complete your beautiful patio furniture.

Please call us directly, not your retailer. As the manufacturer we can walk you through any issues you may have. We are here to help: (888) 682-3012

CUSHION ASSEMBLY

Before beginning, make sure all cushions and covers are present. Make sure you have identified the difference in the seat bottoms and seat backs before pulling on the fabric covers.

PART	DESCRIPTION	QTY
V	Standard Seat Bottom	5
W	Standard Back Cushion	5

STANDARD CUSHION

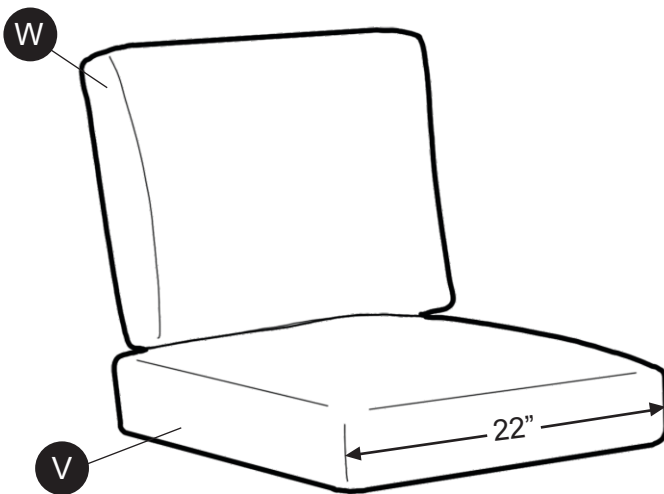

HELPFUL TIP: we call this the 'Taco Method'. Place the cushion between your knees and squeeze together to form a taco. This makes it much easier to pull on the cushion cover.



ASSEMBLY INSTRUCTIONS

1. Push all 3 sofa pieces together and add the two clips (EE) to the top of each chair gap.

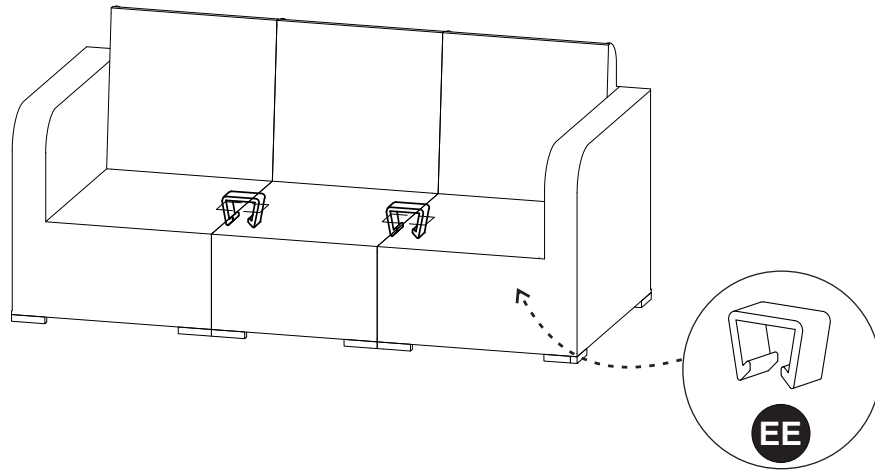

2. Now add all of your cushions and you are ready to enjoy your beautiful furniture. If you have any issues please call (888) 682-3012 directly.

