



Use and Care Guide

Natural Roman Shade

HOME
DECORATORS
COLLECTION

TOOLS REQUIRED

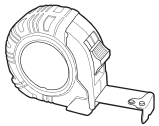

Tape Measure

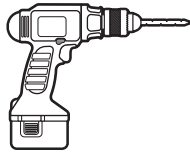

Drill & 1/16" bit

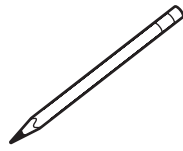

Pencil

CLEANING

May be cleaned with vacuum attachment or duster.

PACKAGE CONTENTS

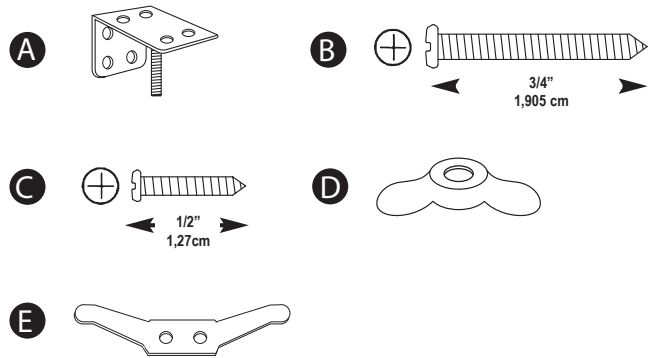

Part	Description	Quantity
A	MOUNTING BRACKET	2 (23"-48") / 3 (52"-72")
B	BRACKET SCREWS	8 (23"-48") / 12 (52"-72")
C	CLEAT SCREWS	2
D	WING NUTS	2 (23"-48") / 3 (52"-72")
E	CORD CLEAT	1

Installation

1 PREPARING FOR INSTALLATION

- Place bracket on the shade by putting bolt through slot on top of shade. Secure and tighten the bracket using a wing nut. (Fig.A)
- Brackets can be mounted behind shade (Fig.A) or brackets can be mounted to the side of shade (Fig.B)

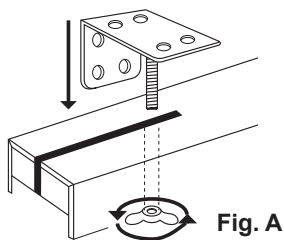

Fig. A

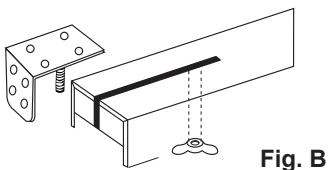

Fig. B

2 POSITION SHADE

- With brackets attached to the shade, hold the shade against the window where the shade will be mounted. Mark position of brackets with a pencil. Remove brackets from shade.

3 INSTALL BRACKETS

- Place brackets at pencil marks. Predrill small holes for screws. Brackets may be mounted to ceiling (Fig.C) or to wall (Fig.D). Screw brackets into place.

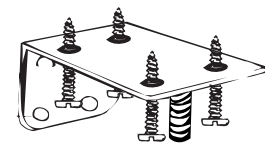

Fig. C

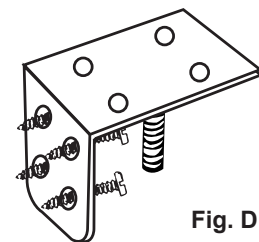

Fig. D



THIS IS NOT RECOMMENDED FOR USE AROUND CHILDREN!