

REPLACEMENT PARTS LIST

ASHBURN 60 IN. VANITY

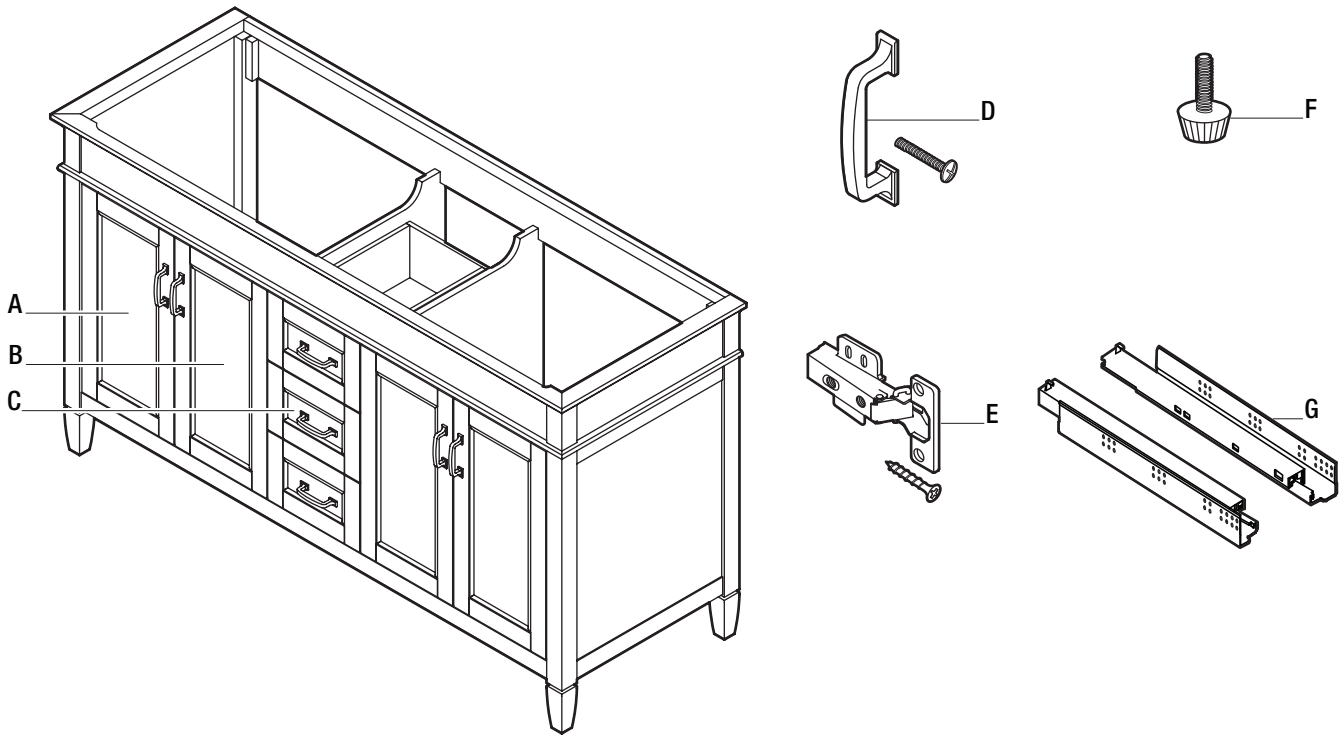

Please use the table below to identify the part number needed, and call FGI Industries, Ltd. Customer Service for your replacement at **888-620-3667**. Our team is available to assist you Monday - Friday, 7:00 A.M. - 5:00 P.M. (CST).

Part	Description	Part #
A	Left Door	PB-ASGRA6021D-LD
B	Right Door	PB-ASGRA6021D-RD
C	Drawer	PB-ASGRA6021D-DRW
D	Door / Drawer Handle (1 handle; 2 screws)	PB-HANDLE-LS157
E	Slow Close Hinge (1 hinge; 4 screws)	PB-SC HINGE-HY006
F	Leg Leveller	PB-L LEVELLER-JD001
G	Drawer Glide	PB-SCDRW GLIDE-HG020