

TM

TrueShelter

6ft x 8ft Green House

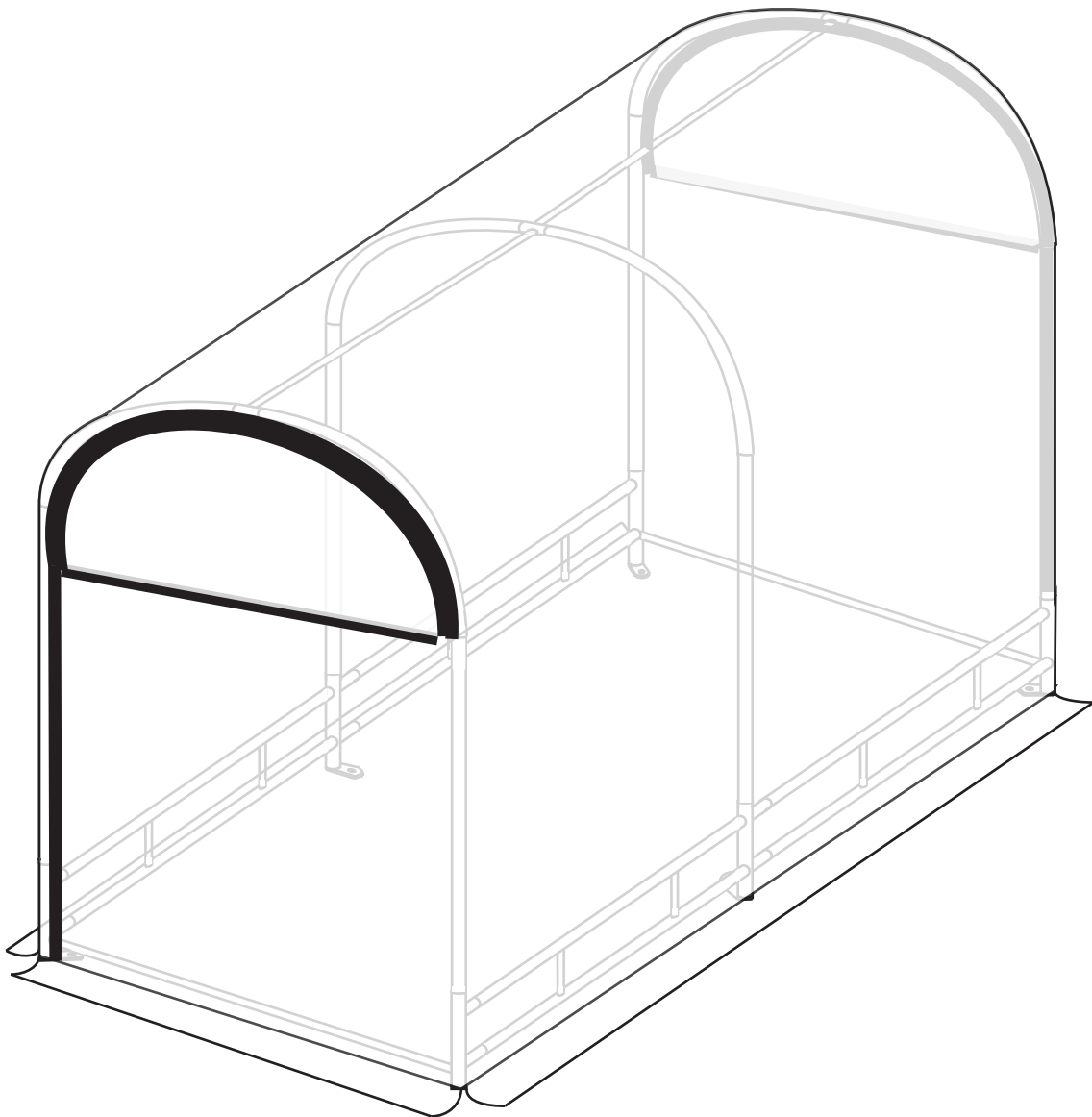

Got a problem building your green house or need replacement parts. Please call our U.S. customer service at toll free 1-877-927-8777 or visit our website at: www.jumpking.com

IMPORTANT INFORMATION

- Inspect the Green House before each use, and replace any worn, defective, or missing parts.
- Warning! Keep away from fire.
- Never shelter in the Green House during a thunderstorm.
- Do not attempt to put up this product in windy, rainy conditions.
- Do not continue to use this product if any part of the frame becomes either bent or broken.
- Warning. Only for domestic use.
- In case of inclement weather, snow, rain and wind, we strongly recommend dismantling the Green House.

CARE & MAINTENANCE

Regular care and maintenance of your product is required. This will help prolong its life and reduce the possibility of injury. Neglecting this can lead to a risk for users.

Inspect your product before each use using the checklist below as a guide. Take particular care in doing this at the start of each season and at regular intervals. Ensure all parts are intact and cannot become dislodged during use, tighten any screws or nuts and bolts where required.

IMPORTANT: If any faults are found, the product **MUST NOT BE USED**. We advise that the product is dismantled and placed in a dry place until new parts are fitted.

| PART | CHECKLIST | OK | NOT OK |
|----------------------------------|----------------------------------|----|--------|
| All Parts (Tubing and screws) | Securely attached | | |
| | Correctly positioned | | |
| | No sharp edges or points present | | |
| | No missing parts | | |
| | No rusting or corrosion | | |
| Cover | No damage | | |
| | No missing parts | | |

Looking after your product:

Use the product as advised : Excess weight and improper use of the product will damage it and cause it to break easily.

Keep clean. If any part becomes dirty, clean with damp cloth and dry thoroughly. Do not use any abrasive cleaners as this could damage the product.

Store the product in a dry place when not in use. Prolonged exposure to sun and harsh weather can shorten its life.

Keep animals/pets away from the product, their claws can damage it.

Protect from high winds. It can be blown over which can cause damage to the frame and surrounding areas. We recommend that it is moved to a sheltered location and secured to the ground, or dismantled and stored away.

Dismantle and store away in a dry place if not being used for long periods. Follow assembly instruction in reverse order.

Take care when moving the product. To be lifted by 2 people. Lift slightly off the ground, keep the frame horizontal. Never drag to move it as can displace parts. Always check that parts are positioned correctly after moving.

BUILDING YOUR GREEN HOUSE

1. This is a 2 person build.
2. Time for build is approximately 1 hour.
3. Choose a good location:
 - On a level surface that is soft (*wood chippings, sand or grass*).
 - Ensure adequate overhead clearance. A minimum of 24ft (7.3m) from ground level, away from wires, trees and other possible hazards.
 - Ensure a clear space of 8.2ft (2.5m) around sides, away from walls, fences, structures, pavement and other hard surfaces and play areas.

WHAT YOU WILL NEED

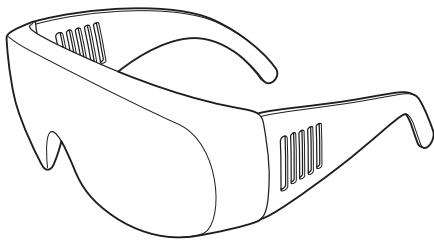

Description:
Safety glasses

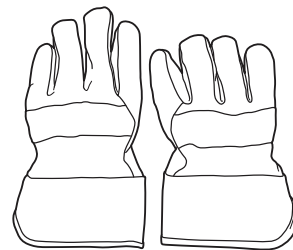



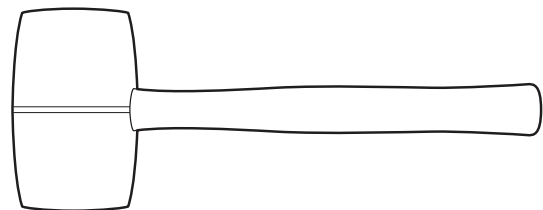





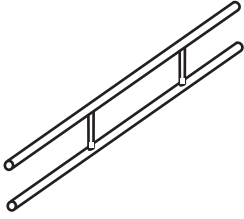



Description:
Gloves

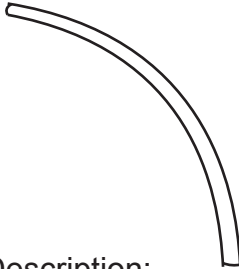
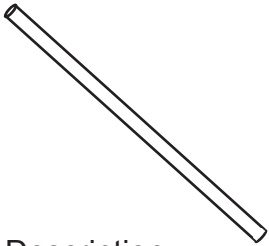

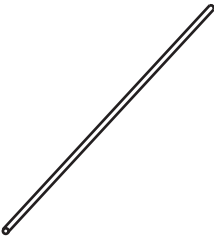
Description:
Mallet

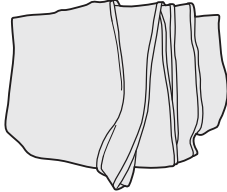
PARTS LIST

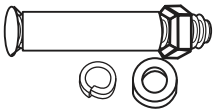
| | | | |
|--|--|---|---|
| <p style="text-align: center;">Part 1</p>  <p>Description: Green bottom frame Quantity: 4 pcs</p> | <p style="text-align: center;">Part 2</p>  <p>Description: Green bottom corner connector Quantity: Left 2 pcs</p> | <p style="text-align: center;">Part 3</p>  <p>Description: Green bottom corner connector Quantity: Right 2 pcs</p> | <p style="text-align: center;">Part 4</p>  <p>Description: Green bottom center connector Quantity: 2 pcs</p> |
| <p style="text-align: center;">Part 5</p>  <p>Description: Green bottom frame Quantity: 2 pcs</p> | <p style="text-align: center;">Part 6</p>  <p>Description: Green bottom frame Quantity: 2 pcs</p> | <p style="text-align: center;">Part 7</p>  <p>Description: Top curve frame Quantity: 6 pcs</p> | <p style="text-align: center;">Part 8</p>  <p>Description: Vertical frame Quantity: 6 pcs</p> |
| <p style="text-align: center;">Part 9</p>  <p>Description: Top T-connector Quantity: 2 pcs</p> | <p style="text-align: center;">Part 10</p>  <p>Description: Horizontal frame Quantity: 2 pcs</p> | <p style="text-align: center;">Part 11</p>  <p>Description: Top 4 way connector Quantity: 1 pc</p> | <p style="text-align: center;">Part 12</p>  <p>Description: Cover Quantity: 1 pc</p> |
| <p style="text-align: center;">Part 13</p>  <p>Description: Metal peg Quantity: 6 pcs</p> | <p style="text-align: center;">Part 14</p>  <p>Description: Expandable screw Quantity: 6 pcs</p> | | |

Assemble the frame according to below diagram:

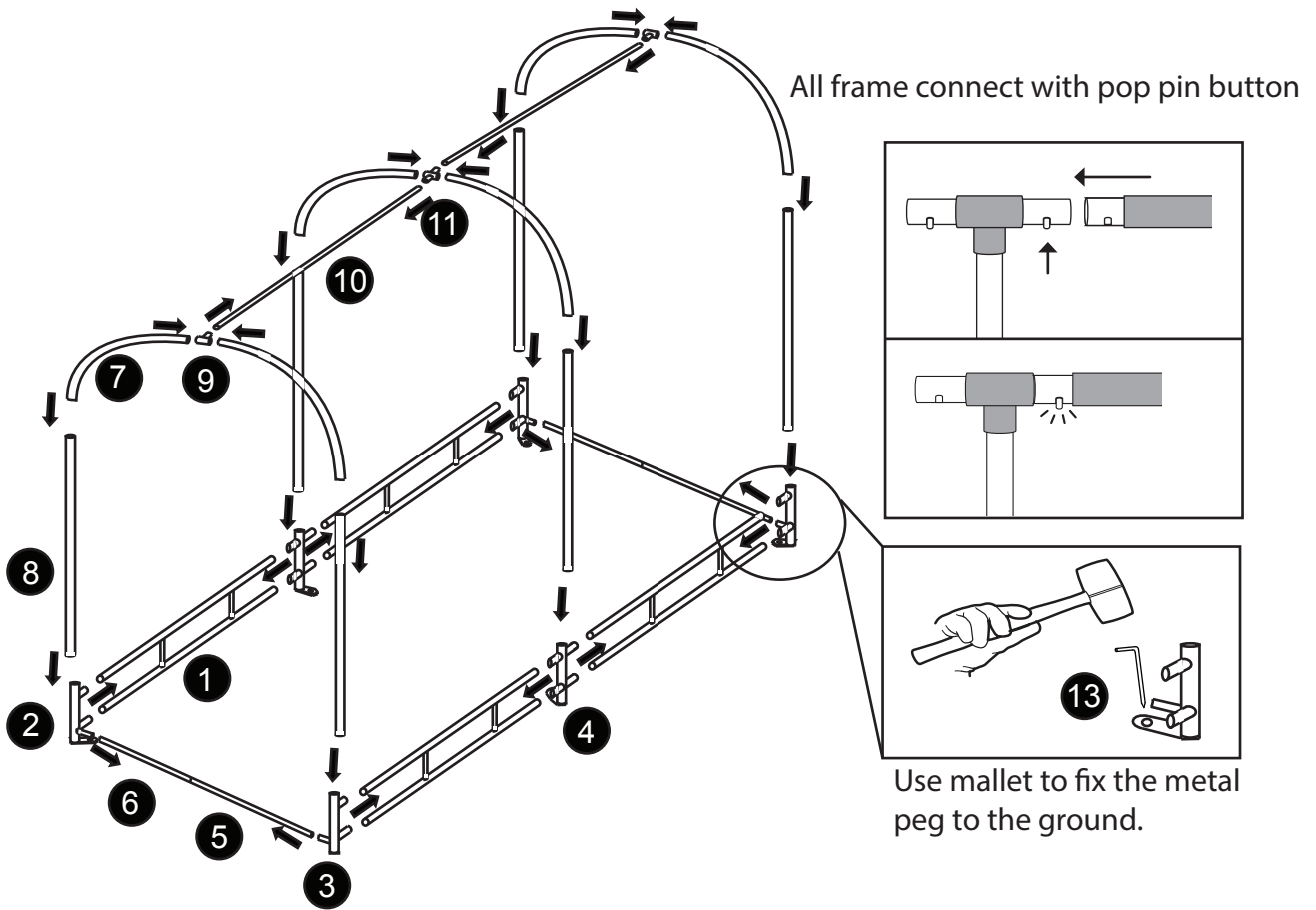

Put the Cover onto the frame:
Make sure all the velcro tape and elastic buckles has fix tighten onto the frame.

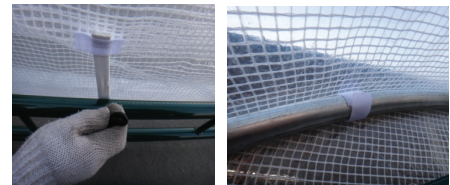
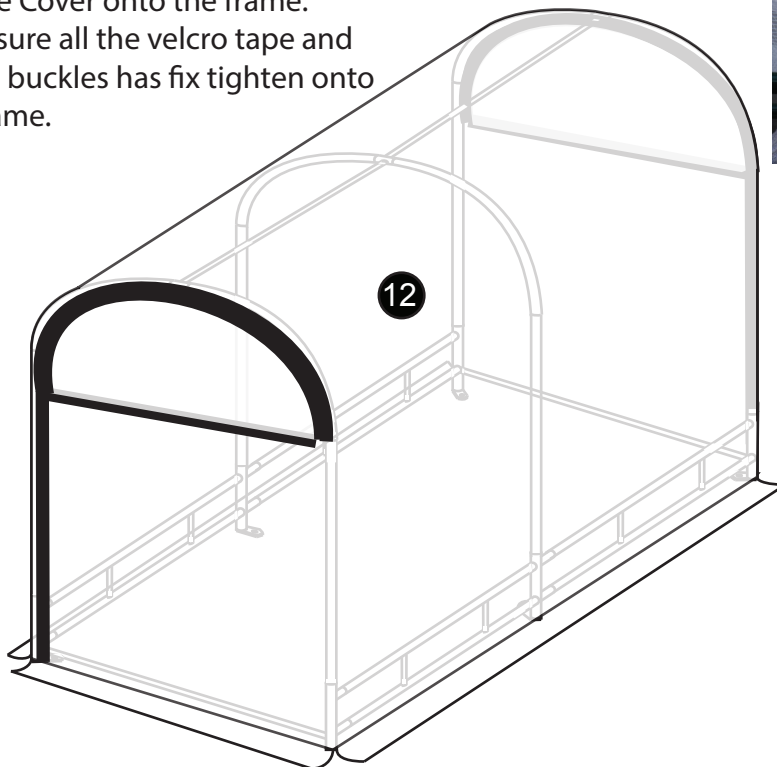

THIS PRODUCT IS NOT SOLD OR INTENDED FOR USE AS A FLAME RETARDANT ARTICLE: This product can be burned and under some conditions may continue to burn once ignited.