

Cordless Top-down/Bottom-up shade

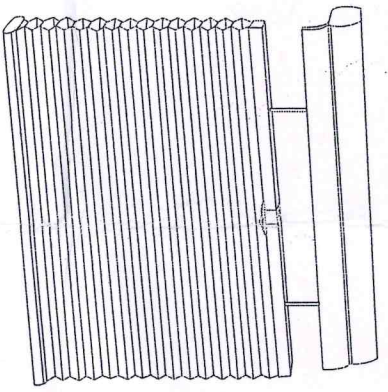

Dear Customer:

The product you have purchased has been engineered and manufactured to the highest standards of quality and performance. To ensure proper installation, please read this instruction sheet carefully before installing your new shade.

Tools needed for installation

- 1) Metal measuring tape
- 2) Pencil
- 3) Phillips screwdrivers
- 4) Step ladder or stool
- 5) Drill & bits (1/8")
- 6) Level

hardware contents

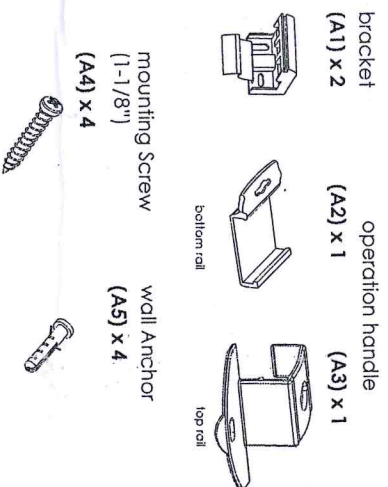

step 1. installing the brackets

inside mount

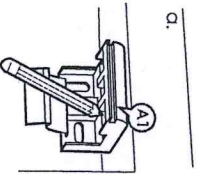

- Pencil mark the mounting screw holes at the top of the bracket.
- Drill holes at the pencil marked locations.
- Position the bracket's near each end of the head rail.

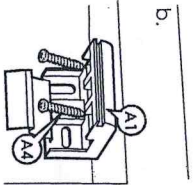

- Secure the brackets with the mounting screws provided.

outside mount

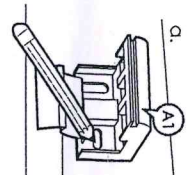

- Pencil mark the mounting screw holes at the back of the bracket.
- Drill holes at the pencil marked locations.
- Use level at top of brackets to ensure straight alignment. Shade needs to be level for proper operation.

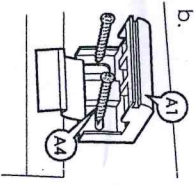

- Secure the brackets with the mounting screws provided.
- When mounting brackets on wall board or plaster, use the wall anchors provided.

step 2. installing the shade

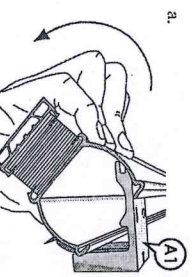

- Insert the flange of the top rail onto the top of the bracket as shown in the drawing then snap-in the rear part of the rail onto the tab of the bracket in a twisting motion.

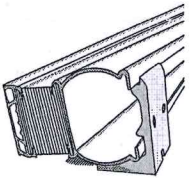

step 3. assembling the operation handle

- Locate the center of each of the rails. Gently lift the shade material out of the way. Fasten the top of the handle onto the middle backside of the top rail depending on operation handle.

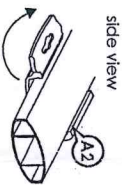

- Rotate the handle upwards until it snaps into place.

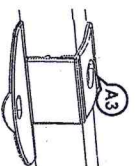

- Rotate the handle downwards until it snaps into place.

step 4. operating the shade

To lower shade

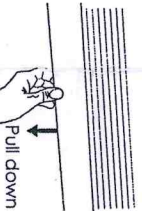

Lowering shade:
Simply grasp the center of the bottom rail and pull the shade down to desired length and release.

To raise shade

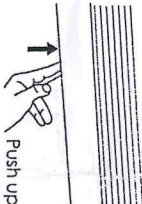

Raising shade:
Simply grasp the center of the bottom rail and push it upward to the desired length and release.

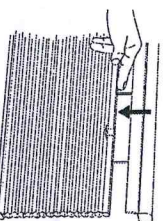

Lowering the headrail:
Simply push down on the headrail to lower it to desired position and release.

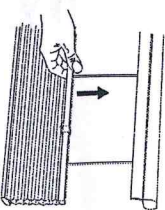

Raising the headrail:
Simply push up on the headrail to raise it to desired position and release.

cleaning your shade:

For best results, we suggest using vacuum cleaner or dry cloth to remove dust. For spot-removal try using light damp cloth to wipe the spot clean. Do not use any kind of chemical to clean the shade as it may damage the shade.

Note: 1. Avoid placing brackets over the spring box or cord pulleys.

2. When installing brackets make sure the brackets do not catch the shade cord(s) against the head rail.

U.S.A Patent No. 6,837,294 & Others Patents Pending

MISSING PARTS: Email: support@welc.com.hk
Made in Taiwan. Finished in China