

PHONESTATION

BY CHARGEHUB™

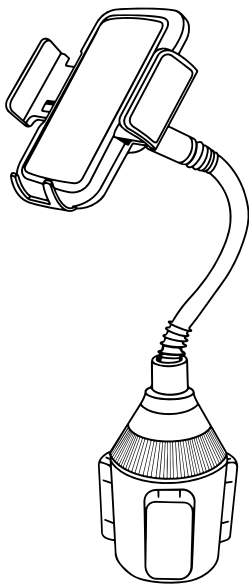

User Manual

Table of Contents

Support & Safety Information	2-3
What's Included	4
Components.....	4-5
Operation Instructions	6-10
Cup Holder Mount.....	6-7
Air Vent Clip	8-9
Adding and Removing a Device	10
Technical Specifications	11
Recommended Accessories.....	12
Limited Warranty	13-17

Support & Safety Information

Your use of the product shall at all times require you to comply with the terms, conditions of use, instructions and recommendations set forth within the User Manual and the Terms and Conditions found at: LimitlessInnovations.com/Warranty

Manual:

LimitlessInnovations.com/Manual/PhoneStation.pdf

Are you having issues with your product?

Contact Customer Support at: LimitlessInnovations.com/Support or call us at (855) 843-4828

By using the PhoneStation, you hereby agree that Limitless Innovations, Inc., an Illinois corporation and its affiliates (“Limitless”) shall have no liability for any losses associated with property damage, personal injury or loss of life that are incurred by you or by any third party in connection with or relating in any manner whatsoever to your use of the PhoneStation. By using the PhoneStation, you hereby agree at all times to comply fully with all safety warnings, operating instructions and general safety information in this User Manual. By using the PhoneStation, you further agree to hold harmless Limitless, (and Limitless’ officers, directors, shareholders and employees) in connection with any losses sustained by you (including, without limitation, losses arising in whole or in part from property damage, personal injury or loss of life) relating in any manner whatsoever to your use of the PhoneStation.

Limitless Innovations does not condone and strongly advises against usage of mobile devices while driving. Please drive safely.

Safety Information cont.

SAFETY WARNINGS

- Please keep the PhoneStation and all accessories out of reach of small children.
- Do **NOT** attempt to open modify the PhoneStation. Doing so will void the warranty.
- Do **NOT** force a device in between the arms of the PhoneStation.
- Limitless Innovations does **NOT** condone and strongly advises against usage of mobile devices while driving. Please drive safely.
- If this device is accessible to or may be used by a minor, purchasing adult agrees to be solely responsible for providing supervision, instruction, and warnings. Purchaser agrees to defend, indemnify, and hold Limitless Innovations harmless for any claims or damages arising from unintended use or misuse by a minor.

What's Included & Components

- 1x Adjustable Phone Mount
- 1x Cup Holder Base with Flexible Neck
- 1x Air Vent Clip
- 1x User Manual

PHONESTATION MOUNT

1. Adjustable Arm Release Button
2. Adjustable Arm Locks
3. Socket Cap
4. Ball Joint Socket
5. Adjustable Foot
6. Adjustable Foot Release Button

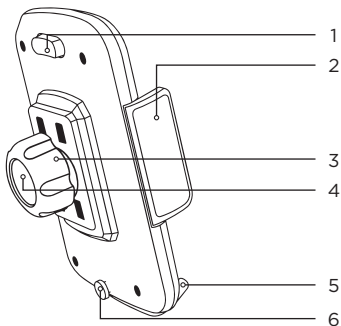

BACK VIEW

Components Cont.

PHONESTATION BASE

- 7. Ball Joint
- 8. Flexible Neck
- 9. Locking Insert Adjustment Dial
- 10. Cup Holder Base
- 11. Locking Inserts

PHONESTATION VENT CLIP

- 12. Vent Clips
- 13. Ball Joint
- 14. Locking Lever

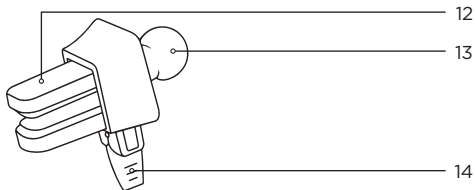
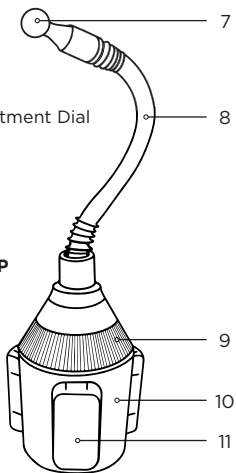

Operation Instructions

Select the preferred installation method and follow the corresponding instructions.

PHONESTATION BASE

1. Place the Socket Cap on the Ball Joint Socket located on the back side of the PhoneStation Base and turn clockwise. Do **NOT** tighten the Socket Cap at this time.
2. Insert the Ball Joint at the end of the Flexible Neck into the Ball Joint Socket of the PhoneStation Base.
3. Turn the Socket Cap clockwise until snug, but do NOT fully tighten at this time. The PhoneStation Base should be able to rotate with applied pressure only.

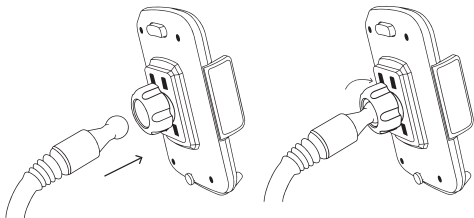

Operation Instructions Cont.

4. With the Locking Inserts fully retracted within the Cup HolderBase, place the PhoneStation Mount in the desired cup holder.



5. Once in place, turn the Locking Insert Adjustment Dial clockwise until the Locking Inserts secure the PhoneStation Base within the Cup Holder.



6. Once in place, adjust the PhoneStation Mount until the desired positioning is achieved. Turn the Socket Cap clockwise until tightened and the PhoneStation Mount is secured in place.

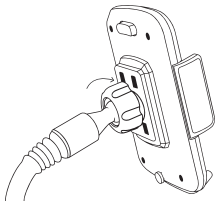

Operation Instructions Cont.

PHONESTATION VENT CLIP

1. Place the Socket Cap on the Ball Joint Socket located on the back side of the PhoneStation Mount and turn clockwise. Do **NOT** tighten the Socket Cap at this time.
2. Insert the Ball Joint of the PhoneStation Vent Clip into the Ball Joint Socket of the PhoneStation Mount.
3. Turn the Socket Cap clockwise until snug, but do **NOT** fully tighten at this time. The PhoneStation Mount should be able to rotate with applied pressure only.

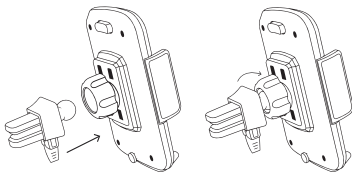

4. With the Locking Lever in the vertical position, slide the PhoneStation Vent Clip onto an air vent fin.

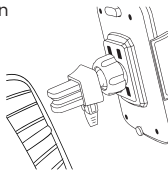

Operation Instructions Cont.

5. Once you have the PhoneStation Mount in the desired location, flip the Locking Level to the side to tighten the Vent Clips.

NOTE:

- a. For larger vents, flip the Locking Lever to the "I" position.
- b. For smaller vents, flip the Locking Lever to the "II" position.

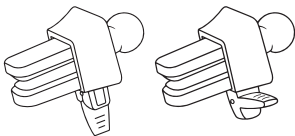

6. Once in place, adjust the PhoneStation Mount and until the desired positioning is achieved. Turn the Socket Cap clockwise until tightened and the PhoneStation Mount is secured in place.

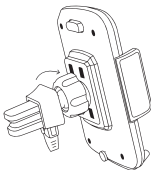

Operation Instructions Cont.

ADDING AND REMOVING A DEVICE

1. Press and hold the Adjustable Arm Release Button on the top-back of the PhoneStation Mount until the arms are fully expanded.



2. Press and hold the Adjustable Foot Release Button on the bottom-back of the Phone Mount and pull/push the Foot until it is in the desired position.

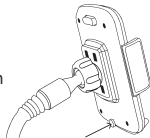

3. Place a mobile device on the Adjustable Foot and against the back of the PhoneStation Mount.

4. Close the Adjustable Arms by squeezing them in until the device is secured to the PhoneStation Mount.

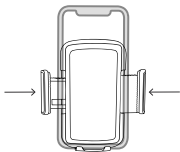

5. To remove the device from the PhoneStation Mount, press and hold the Adjustable Arm Release Button on the top-back of the PhoneStation Mount until the arms are fully expanded.

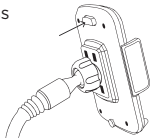

Technical Specifications

Specifications	Measurement	Units
Minimum Arm Opening	2"	Inches
Maximum Arm Opening	3.5"	Inches
Minimum Cup Holder Diameter	2.25"	Inches
Minimum Cup Holder Diameter	3.25"	Inches

Recommended Accessories

- **ChargeHub V2 - 2-Port Car Charger**
- **ChargeHub V3 - 3-Port Car Charger**
- **React 7-in-1 Multi Tool by ChargeHub**
- **CableLinx USB Charging Cables**

It is critical to use ChargeHub-branded power supplies and approved adapters, only. Use of non-approved ChargeHub products may cause safety hazards and damage your personal electronic devices under charge. For a list of approved ChargeHub accessories, visit our website at:

LimitlessInnovations.com/Shop

Limited Warranty

We stand behind each product with a (1) Year Limited Warranty by Limitless Innovations.

Subject to the exclusions contained below, Limitless Innovations, Inc. (“Limitless”) warrants the PhoneStation product to be free from defects in materials and workmanship under normal consumer usage for a period of one (1) year from the date of original purchase, (the “PhoneStation Limited Warranty”). As utilized herein, the term “PhoneStation” (or the singular, PhoneStation product) shall include all products set forth above in the what’s included section of this User Manual that may be sold by Limitless now or in the future.

This PhoneStation Limited Warranty is a consumer’s sole and exclusive remedy regarding any express warranty claim by a consumer and is subject to the exclusions on the following pages:

Exclusions: The PhoneStation Limited Warranty shall not apply in the event of the occurrence of any of the following:

- 1. Normal Wear and Tear.** The PhoneStation Limited Warranty shall not apply to cover the maintenance, repair and/or replacement of parts or the PhoneStation products due to normal wear and tear by the consumer.
- 2. Abuse and Misuse.** The PhoneStation Limited Warranty shall not cover defects or damage that result in whole or in part from: (a) improper operation, storage, misuse or abuse, accident or neglect by the consumer (including, without limitation, physical damage, cracks and scratches to the surface of the PhoneStation product; (b) contact with liquid, water,

Limited Warranty Cont.

rain, extreme humidity or heavy perspiration, sand, dirt or the like, extreme heat, or food; (c) use of the PhoneStation product for commercial purposes; (d) subjecting the PhoneStation product to abnormal usage or conditions; and/or (e) other acts which are not the sole and absolute fault of the PhoneStation.

3. Unauthorized Service or Modification. The PhoneStation Limited Warranty shall not cover defects or damages resulting in whole or in part from service, testing, adjustment, installation, maintenance, alteration, or modification in any way by someone other than PhoneStation or its authorized service centers.

4. Altered Products. The PhoneStation Limited Warranty shall not cover defects or damages to a PhoneStation product with (a) serial numbers or date tags that have, at any time, been removed, altered, or obliterated; (b) broken seals or that show evidence of tampering; (c) mismatched board serial numbers; or (d) non-conforming or non-PhoneStation housings, or components.

5. Communication Services. Defects, damage, or the failure of the PhoneStation products due to any communication service or signal you may subscribe to or use with the PhoneStation product or software.

WHO IS COVERED?

This warranty extends only to the first consumer purchaser and is not transferable to any third party nor applicable to any subsequent owner other than the first consumer purchaser.

Limited Warranty Cont.

WHAT WILL LIMITLESS DO?

If Limitless determines, in its sole and absolute discretion, that a claim is subject to the PhoneStation Limited Warranty, it will, at its sole option, repair or replace the PhoneStation product or alternatively, it will, in its discretion, refund the purchase price of any PhoneStation products or software. The PhoneStation product replacement will be with a functionally equivalent reconditioned / refurbished / pre-owned or new PhoneStation product or part.

For additional information, visit us at:
LimitlessInnovations.com/Support
or call us at (855) 843-4828

WHO DO I CONTACT TO MAKE A CLAIM?

In the event of any warranty claim under the PhoneStation Limited Warranty, you can contact the telephone number below or provide a written correspondence to the address below at which time and in response thereto, you will receive instructions on how to ship any PhoneStation product at your expense, to a Limitless authorized repair center. To obtain service, you must include: (a) a copy of your receipt, bill of sale or other comparable proof of purchase; (b) a written description of the problem; (c) the name of your service provider, if applicable; and (d) your mailing address, email address and telephone number.

Mailing Address

(Please call (855) 843-4828 first to obtain RMA #)
Limitless Innovations, Inc.
4800 Metalmaster Way
McHenry, IL 60050

Limited Warranty Cont.

WHAT OTHER LIMITATIONS ARE THERE?

ANY WARRANTY CLAIM SHALL BE LIMITED TO LIMITLESS COST OF MATERIAL ON THE PRODUCT DETERMINED TO HAVE A MANUFACTURER'S DEFECT. IN NO EVENT SHALL LIMITLESS BE LIABLE TO ANY PARTY FOR ANY LABOR COSTS OR ANY OTHER DIRECT, INDIRECT, CONSEQUENTIAL, INCIDENTAL OR SPECIAL DAMAGES, WHETHER IN CONTRACT OR TORT AND LIMITLESS EXPRESSLY DISCLAIMS LIABILITY FOR ANY DAMAGES OF ANY KIND ARISING UNDER ANY THEORY OF LAW WHATSOEVER. THE PERFORMANCE OF THE PRODUCT DEPENDS ON THE PURCHASER'S ADHERENCE TO MANUFACTURER PRODUCT INSTRUCTIONS AND LIMITLESS WILL NOT BE RESPONSIBLE TO PURCHASER FOR ANY DEVIATIONS THEREFROM. SOME STATES DO NOT ALLOW THE EXCLUSION OR LIMITATION OF INCIDENTAL OR CONSEQUENTIAL DAMAGES, SO THE ABOVE LIMITATION OR EXCLUSION REGARDING INCIDENTAL OR CONSEQUENTIAL DAMAGES MAY NOT APPLY TO YOU. ALL IMPLIED WARRANTIES, INCLUDING, WITHOUT LIMITATION, THE IMPLIED WARRANTY OF MERCHANTABILITY AND THE IMPLIED WARRANTY OF FITNESS FOR A PARTICULAR PURPOSE SHALL EXPIRE ON THE DATE WHICH IS 1 YEAR FROM THE DATE OF FIRST PURCHASE OF THE PRODUCT BY THE CONSUMER. SOME STATES DO NOT ALLOW LIMITATIONS ON HOW LONG AN IMPLIED WARRANTY LASTS, SO THE ABOVE LIMITATION MAY NOT APPLY TO YOU. WITH RESPECT TO THAT PERIOD OF TIME BEYOND THE 1 YEAR LIMITED WARRANTY PERIOD, LIMITLESS DISCLAIMS AND FURTHER MAKES NO

Limited Warranty Cont.

WARRANTY OF ANY KIND, EXPRESS OR IMPLIED, INCLUDING BUT NOT LIMITED TO, ANY WARRANTY OF MERCHANTABILITY OR WARRANTY OF FITNESS FOR A PARTICULAR PURPOSE.

PLEASE NOTE THIS LIMITED WARRANTY GIVES YOU SPECIFIC LEGAL RIGHT, AND YOU MAY ALSO HAVE OTHER RIGHTS WHICH VARY FROM STATE TO STATE.

NATIONAL STATUTORY RIGHTS

CONSUMERS IN SOME JURISDICTIONS MAY HAVE LEGAL RIGHTS UNDER APPLICABLE NATIONAL LEGISLATION GOVERNING THE SALE OF CONSUMER GOODS, INCLUDING, WITHOUT LIMITATION, NATIONAL LAWS IMPLEMENTING EC DIRECTIVE 99/44. THESE RIGHTS ARE NOT AFFECTED BY THE WARRANTIES IN THIS LIMITED WARRANTY.

For the full Warranty, Terms, and Conditions, please visit:
www.LimitlessInnovations.com/Warranty

PHONESTATION BY CHARGEHUB™

All rights reserved. PhoneStation is a registered trademark of Limitless Innovations, Inc. Design and specifications subject to change without notice. Products may vary from images shown.

All other trademarks included herein are property of their respective owners.

Made in China

Phone: (855) 843-4828

Email: Sales@LimitlessInnovations.com

Website: LimitlessInnovations.com

© Limitless Innovations, Inc.



[@LimitlessInnovations](https://www.instagram.com/LimitlessInnovations)



[/LimitlessInnov](https://www.facebook.com/LimitlessInnov)



[/LimitlessInnov](https://twitter.com/LimitlessInnov)



[/LimitlessInnov](https://www.pinterest.com/LimitlessInnov)



[Limitless Innovations](https://www.youtube.com/LimitlessInnovations)