



# **PURE SINE WAVE POWER INVERTER**

## Instruction Manual

MODEL:  PS1001       PS1004  
 PS1002       PS1005  
 PS1003



## IMPORTANT SAFETY INSTRUCTIONS

1. This section contains important safety and operating instructions. Read and keep this user manual for future reference.
2. Do not expose the Pure sine inverter to rain, snow, or spray water. To reduce the risk of fire hazard, do not cover or obstruct the ventilation openings. Do not install the Pure sine inverter in a zero-clearance compartment. Overheating may result.
3. To avoid a risk of fire and electric shock, make sure the existing wiring is in good condition and is not undersized. Do not operate the PURE SINE with damaged or substandard wiring.
4. Do not disassemble the Pure sine inverter. It contains no user-serviceable parts. See the WARRANTY section for instructions or obtaining service. **Attempting to service the Pure sine inverter yourself may result in a risk of electrical shock or fire. Internal capacitors remain charged after all power is disconnected.**
5. **To reduce the risk of electrical shock, disconnect both AC and DC power from the Pure sine before attempting any maintenance, cleaning, or working on any circuits connected to the Pure sine inverter. Turning off controls alone will not reduce this risk.**



## **WARNING : EXPLOSION HAZARD**

1. Working in the vicinity of lead-acid batteries is dangerous. Batteries generate explosive gases during normal operation. Therefore, you must read this guide and follow the instructions before installing or using your inverter.
2. This equipment contains components which tend to produce arcs or sparks. To prevent fire or explosion, do not install the Pure sine inverter in compartments containing batteries, flammable materials, or in locations that require ignition protected equipment. This includes any space containing gasoline powered machinery, fuel tanks, as well as joints, fittings, or other connections between components of the fuel system.



## PRECAUTIONS WHEN WORKING WITH BATTERIES

1. Make sure the area around the battery is well ventilated.
2. Never smoke or allow a spark or flame near the engine or batteries.
3. Use caution to reduce the risk of dropping a metal tool on the battery. It could spark or short circuit the battery or other electrical parts and could cause an explosion.
4. Remove all metal items, like rings, bracelets, and watches when working with lead-acid batteries. Lead-acid batteries produce a short circuit current high enough to weld metal to skin, causing severe burn.
5. Have plenty of fresh water and soap nearby in case battery acid contacts skin, clothing, or eyes.
6. Wear complete eye protection and clothing protection. Avoid touching your eyes while working near the batteries.
7. If battery acid contacts skin or clothing, wash immediately with soap and water. If acid enters your eye, immediately flood it with running cold water for at least twenty minutes and get medical attention immediately.
8. If you need to remove a battery, always remove the ground terminal from the battery first. Make sure all accessories are off so you don't cause a spark.

## SPECIFICATIONS

Item	PS1001	PS1002	PS1005	PS1003	PS1004
Continuous output frequency	600W	1000W	1500W	2000W	3000W
Surge power	1200W	2000W	3000W	4000W	6000W
Input voltage range (12V)	10-16VDC				
Input under voltage activation (12V)	10.6VDC				
Input under voltage protection (12V)	10VDC				
Input under voltage protection (12V)	16VDC				
Input voltage	12V				
Output voltage	120V AC $\pm$ 10%				
Output frequency	60Hz $\pm$ 1Hz				
Output waveform	Pure sine wave (THD $\leq$ 3%)				
Conversion efficiency	90%				
Overload protection	Yes				
Thermal protection	149°F $\pm$ 40°F(65°C $\pm$ 5°C)				
Use of advanced microprocessor control	Yes				
USB Output	5VDC, 1A			5VDC, 2.1A	
Display	LED indicator				

CONTINUED ON NEXT PAGE

## SPECIFICATIONS (CONTINUED)

Item	PS1001	PS1002	PS1005	PS1003	PS1004
Length of the remote controller wire	15 ft. (4.6m) only for model PS1002 & PS1003 & PS1004 & PS1005				
Intelligent cooling	the fan starts to work when the load power is larger than 100W, does not work when no load or small load		The cooling fan on the product will not run when start up the inverter, it will start running only when the case temperature reaches about 40°C.		
Fuse (outer car fuse)	40Ax2	40Ax4	40Ax6	40Ax8	40Ax12
Dimension (LxWxH)	8.4"x5.5"x3"	11.5"x5.5"x3"	15.8"x9.3"x4"	17.1"x9.3"x4"	22"x9.3"x4"
Weight	3.7LBs	5.3LBs	9.9LBs	11.4LBs	14.8LBs
Working temperature	32°F ~ 104°F (0°C~40°C)				
Storage temperature	-14°F ~ 113°F (-10°C~45°C)				
Battery cables	The offered battery cables are only for small output, please choose larger battery cable for larger output				

## PRODUCT INFO

This power inverter is an advanced tool of power conversion, and it can supply you with AC power converted from DC power source. Not only can it be used in cars, vessels, and camping vehicles, it can also be used in an emergency if the power fails.

In order to use the inverter efficiently and safely, please install and use it in a proper way. Please read the instructions carefully before installing and using the appliance.

### WARNING AND SAFETY

1. Read the manual before use and keep in a safe place for future reference.
2. Don't put the inverter under sunlight, near a heating source, wet or humid environment.
3. The case housing of inverter will be hot when in use. Keep the inverter away from materials that cannot withstand high temperature, such as clothing, sleeping bags, carpets, etc.
4. This power inverter is designed for use with negative ground electrical system. Don't use with positive ground electrical systems (the majority of modern automobiles, RVs, trucks, and boats are negative ground).
5. Do not disassemble the unit. Disassembling may cause fire or electrical shock.
6. Keep the inverter out of reach of children.
7. The power inverter will output AC power as utility power. Use extreme care with and around the output terminal. **DO NOT PUT ANYTHING INTO THE OUTPUT TERMINAL EXCEPT FOR AN ELECTRICAL APPLIANCE PLUG.**

CONTINUED ON NEXT PAGE

## WARNING AND SAFETY (CONTINUED)

8. Disconnect the battery and inverter when it is not in use.

### PS1001 PARTS LIST

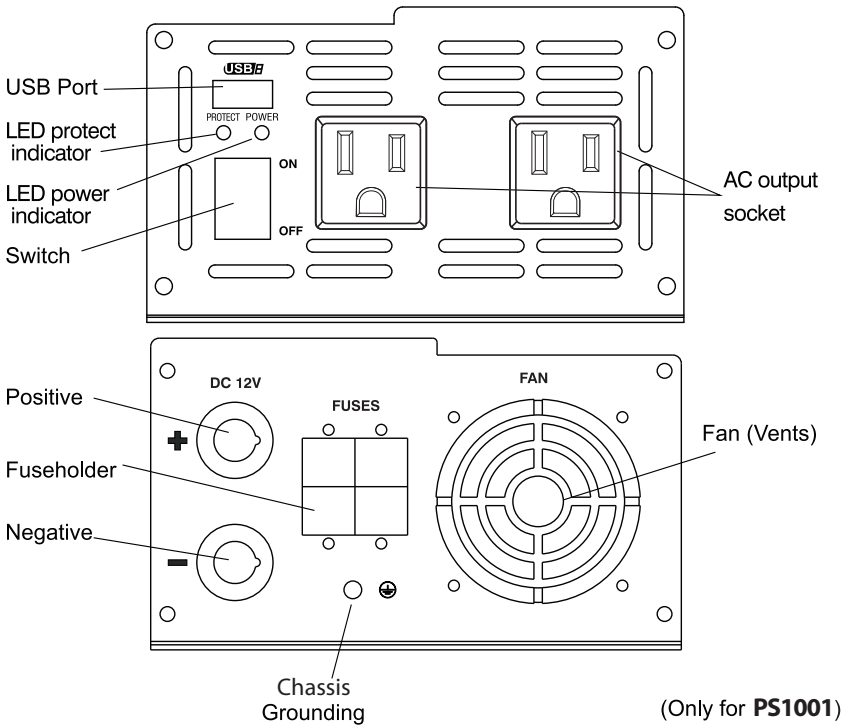



# PS1002 PARTS LIST

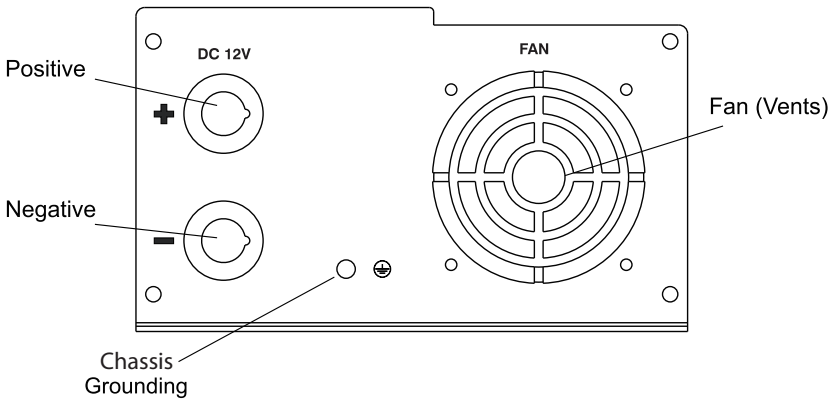
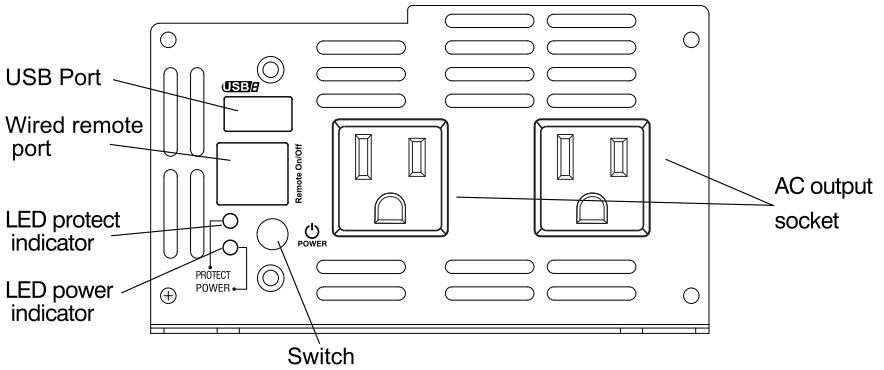

(Only for **PS1002**)

## PS1003, PS1004, PS 1005 PARTS LIST

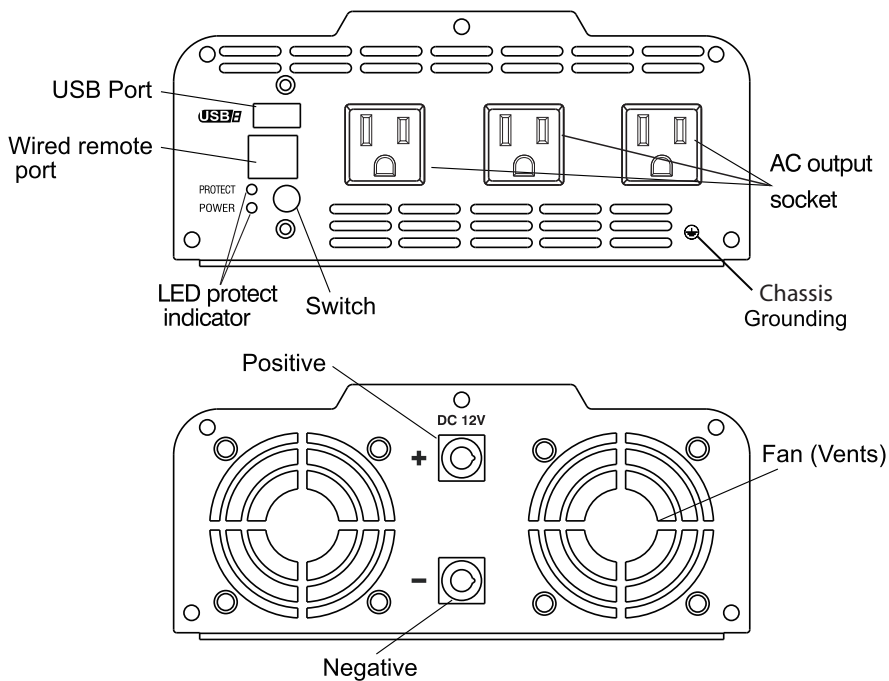

(Only for **PS1003, PS1004, PS1005**)

## REMOTE CONTROL BOX

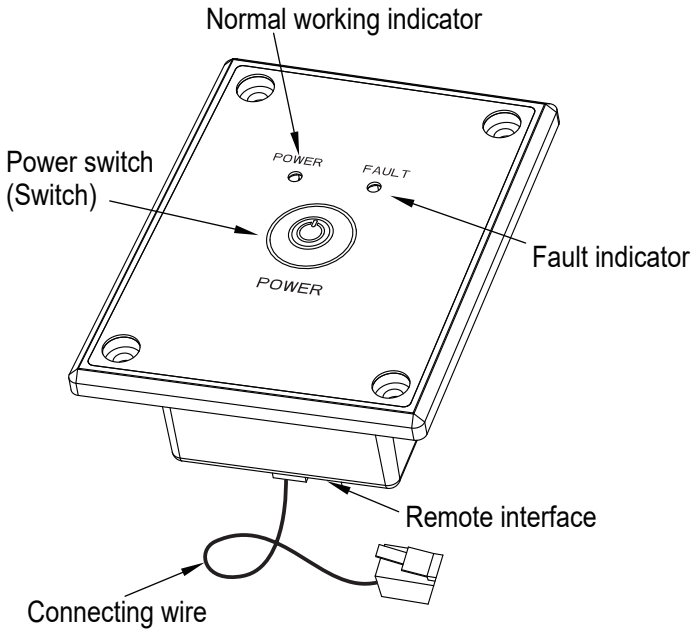

## INSTALLATION AREA

1. Before installing the Pure sine inverter, the area or location **MUST** meet the following requirements:

**DRY** - Do not allow water or other fluids to drip or splash on the Pure sine inverter. **DO NOT MOUNT THE INVERTER IN AN AREA SUBJECT TO SPLASHING WATER AND SPRAY WATER.**

**COOL** - Normal air temperature should be between 32°F and 104°F (0°C and 40°C)- the cooler the better.

CONTINUED ON NEXT PAGE

## **INSTALLATION AREA (CONTINUED)**

**VENTILATION** - Allow at least 5 inches (13cm) of space at the DC end of the Pure sine inverter for air flow, 1 inch (2.5cm) on each side, and 2 inches (5cm) at the AC end of the inverter. For cooling, the size of the space is not as important as the overall supply of air. The more clearance for ventilation around the unit, the better the performance. **DO NOT** allow the ventilation openings on the ends of the unit to become obstructed.

**SAFETY** - Do not install Pure sine inverter in the same compartment as batteries or in any compartment capable of storing flammable liquids like gasoline.

**CLOSE THE BATTERY COMPARTMENT AND THE AC SOURCE AND LOAD PANELS.** Avoid excessive cable lengths (which reduce input and output power due to wire distance).

CONTINUED ON NEXT PAGE



## **WARNING : FIRE & EXPLOSION HAZARD**

This equipment contains components that tend to produce arcs and sparks. To prevent fire or explosion, do not install the Pure sine inverter in compartments containing batteries or flammable materials or in locations that require ignition-protected equipment. This includes any space containing gasoline-powered machinery, fuel tanks, or joints, fittings, or other connections between components of the fuel system.

### **INSTALLATION OF INVERTER**

The weight of the inverter is very heavy. Be sure to place the inverter on a stable surface such as the floor, a table, or stand. Make sure the areas you place the inverter on can withstand the weight of the inverter. In addition, be sure to affix the product with the provided screws to keep the inverter from falling or moving.

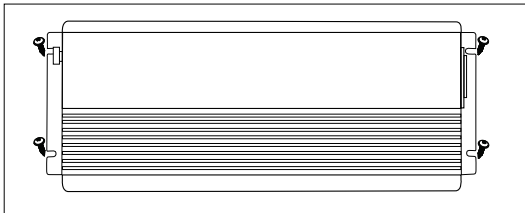

## **INSTALLATION OF REMOTE CONTROL BOX**

(For PS1002, PS1003, PS1004, & PS1005)

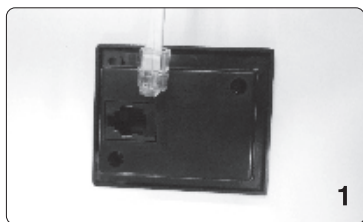

1. The remote is designed to be mounted on a dash or other flat surface.
2. The remote cable should be plugged into inverter and the remote before being mounted. NOTE: The remote is optional and not required for inverter operation. The main power switch will turn the power on/off.

## **HOW TO INSTALL THE DC CIRCUIT BREAKER (DC CIRCUIT BREAKER IS NOT INCLUDED)**

The DC circuit from the battery to the inverter should be equipped with a disconnect and over-current device. This usually consists of a circuit breaker, a “fused-disconnect”, or a separate fuse and DC disconnect. Do not confuse AC circuit breakers with DC circuit breakers. They are not interchangeable. The rating of the fuse or breaker must be matched to the size of cables used in accordance with the applicable installation codes. The breaker or disconnect and fuse should be located as close as possible to the battery, in the positive cable. Applicable codes may be limited as to how far the protection can be from the battery. The picture on the next page is for your reference.

# HOW TO INSTALL THE DC CIRCUIT BREAKER (DC CIRCUIT BREAKER IS NOT INCLUDED)

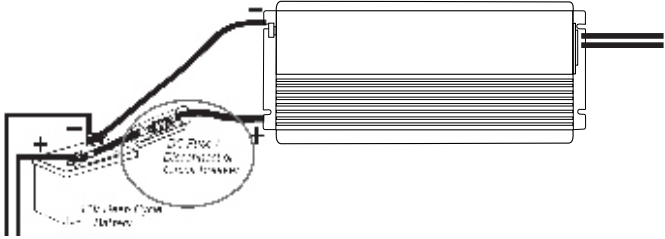

Before making the final DC connection, check cable polarity at both the battery and the Pure sine inverter. Positive must be connected to positive; negative must be connected to negative. Reversing the positive and negative battery cables will damage the Pure sine inverter and void your warranty.



Operation of the inverter without a proper ground connection may result in an electrical safety hazard. Chassis Ground (Grounding) : Ground to vehicle chassis using #8 AWG wire.

## USING THE INVERTER

### PS1001

1. Check the output voltage and capacity of the battery. It should comply with the requirement of the product used.
2. Connect the battery and the DC cable of the inverter. Ensure that the polarities are not reversed and are in good contact.
3. Turn on the switch. The green LED power indicator light should be on.
4. Turn off electrical appliance and insert the electrical appliance plug to the AC output socket of the inverter. Turn on the electrical appliance for use.
5. Turn off the electrical appliance and inverter if you are no longer going to use them. Disconnect the inverter from the battery if it will not be in use for a long period of time.



## USING THE INVERTER (CONTINUED)

### PS1002, PS1003, PS1004, & PS1005

1. Check the output voltage and capacity of the battery. It should comply with the requirement of the product used.
2. Connect the battery and the DC cable of the inverter. Ensure that the polarities are not reversed and are in good contact.
3. Press and hold the power switch on the inverter or the remote control box for at least 5 seconds. The power indicator on the inverter and remote control box should be on (this will avoid interference).
4. Turn off electrical appliance and insert the electrical appliance plug to the AC output socket of the inverter. Turn on the appliance for use.
5. The inverter's cooling fan will start running when the case temperature reaches about 100°F.
6. When the inverter is not in use, turn the inverter off by pressing the power switch on the inverter or remote control box. The power indicator light should be off. This will conserve the battery power.

## **HOW TO USE THE USB POWER SUPPLY**

Models PS1001, PS1002, & PS1005 USB output can provide stable 5V DC voltage power. The maximum current is 1000mA (PS1003 & PS1004 maximum current is 2.1A).

NOTE: Before using the USB power supply, make sure the device can be charged by USB and the maximum working current is no more than 1000mA (PS1003 & PS1004 maximum working current is no more than 2.1A)

## **BATTERY OPERATING TIME**

Battery operating time depends on battery capacity (AH) and load power (W), the calculation formula of operating time is: battery capacity (AH) x battery output voltage (V) ÷ load power (W)

For example: Battery specification: 12V 200Ah, load power is 300W, then the operating time is  $200 \times 12 \div 300 \approx 8$  hours

## **SOFT START TECHNOLOGY**

This unit uses the latest in soft start technology. The output voltage gradually increases to the normal value from low value after the inverter is turned on. It can reduce the transient large current attack and help to start the hard start load. Large power inductive load, such as electrical motor or capacitive loads (large power SMPS), adopt soft start. Turn on the “load switch”, then turn on the “inverter switch.”

## OUTPUT VOLTAGE & WAVEFORM

The output waveform of the inverter is pure sine wave, which has the same waveform of the sine utility power, or even higher than the purity of the domestic power. This kind of waveform is suitable for most electrical appliances, including linear and switching in electronic equipments, transformers, motor etc.

Compared with modified sine wave inverters, the power factor and power utilization of electric fans, refrigerators and other inductive loads can be improved by using pure sine wave inverters. The noise during appliance operation can be effectively reduced too.

Pure Sine Wave Output  
(120 VAC Model)

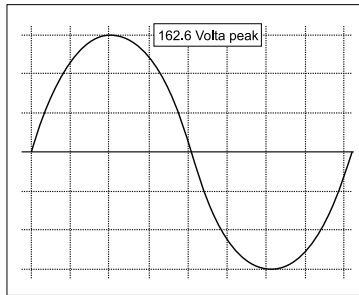

## FUNCTIONS

1. Input under-voltage alarm: When the input DC voltage is lower than 10.6V, the buzzer will whistle intermittently to warn the user that the inverter will go into the under voltage protection. If this happens, be sure to save all your data if a computer is being used.
2. Under voltage protection: The inverter will automatically shut down when the input DC voltage is higher than 16V. The buzzer will whistle continuously. The green light will turn off and the red light will turn on. Turn off the inverter and charge the battery before continuing use.
3. Over voltage protection: The inverter will automatically shut down when the input DC voltage is higher than 16V. The buzzer will whistle continuously and the switch indicator light will turn on. If this happens, turn off the inverter and adjust the input voltage to the allowed range.
4. Overload protection: The inverter will automatically shut down when the load power is higher than the rated power. The buzzer will whistle continuously. Turn off the inverter and resume normal operation after taking away the redundant load.
5. Thermal protection: The unit will be hot during operation. If the temperature is higher than 149°F, the inverter will automatically shut down. The buzzer will whistle continuously, the green light will turn off, and the red light will turn on. Turn off the inverter.

CONTINUED ON NEXT PAGE

## **FUNCTIONS (CONTINUED)**

You may continue using it after the temperature returns back to normal. Meanwhile, find out what factors are causing the inverter to overheat. Such factors may be poor ventilation, ambient temperature, vent, load power, etc.

## TROUBLESHOOTING

Fault/Display	Cause	Solutions
No output voltage, buzzer sounds continuously	Low input DC voltage	Recharge or replace the battery
	High input DC voltage	Do not use it when the battery is charging. Check the rated voltage of the battery and make sure that it is in the allowable range of the input voltage
	Overload	Reduce the load power
	Over temperature	Cut off the load and keep it cool naturally for 10 to 30 minutes. Restart it after it returns to normal temperature. The load power is too large and reduce the total load power to the range of rated power. Avoid blocking the vent and improve the ventilation condition. Reduce the ambient temperature.
No output voltage	<ol style="list-style-type: none"> <li>1. The switch is off</li> <li>2. The battery lead is not connected</li> </ol>	<ol style="list-style-type: none"> <li>1. Turn on the power switch</li> <li>2. Check the joint and make sure it's well connected</li> </ol>

CONTINUED ON NEXT PAGE

## TROUBLESHOOTING (CONTINUED)

Fault/Display	Cause	Solutions
Incorrect output voltage	<ol style="list-style-type: none"> <li>1. RMS Multimeter measurement error</li> <li>2. The battery power of RMS multimeter is low, the input voltage is too high or low</li> </ol>	<ol style="list-style-type: none"> <li>1. Use a true RMS multimeter to measure, such as the model FLUKE 177/179</li> <li>2. Try to maintain the input voltage in the range of rated power</li> <li>3. Change the battery of the multimeter then test again</li> </ol>
Cannot drive the load	<ol style="list-style-type: none"> <li>1. Load power is too large, or the actual power of the appliance exceeds nominal power.</li> <li>2. The starting power is larger than rated power (such as motor)</li> </ol>	Reduce a load power, or open the appliance first, then open the inverter, the inverter internal soft-start circuit to buffer start the appliances
When using with TV or audio, static on screen or static noise, or no audio	Disturbance	<ol style="list-style-type: none"> <li>1. Separate the inverter and antenna</li> <li>2. Use screened antenna</li> </ol>

If the inverter still malfunctions after all solutions have been exhausted, please contact Power Tech-On for further assistance at 1-844-539-7991.

## **WARRANTY**

This product is warranted against defects in materials and workmanship for one year from the date of purchase, when used in accordance with the instructions provided. This warranty does not cover damages or wear resulting from accident, misuse, abuse, commercial use, or unauthorized adjustment and/or repair.

Power Tech-On shall not be liable for loss of use or any other incidental, consequential or indirect costs, expenses or damages. There are no express warranties except as listed above. This warranty gives you specific legal rights, and you may have other rights which vary from state to state.

Should this product require service (or replacement at our option) while under warranty, CALL 1-844-539-7991 for RETURN INSTRUCTIONS. Be sure to keep your receipt showing the date of purchase.

Power Tech-On  
3000 E. Chambers St.  
Phoenix, AZ 85040  
1-844-539-7991







