

FIRMAN[®]

OPERATOR'S MANUAL GASOLINE PORTABLE GENERATOR

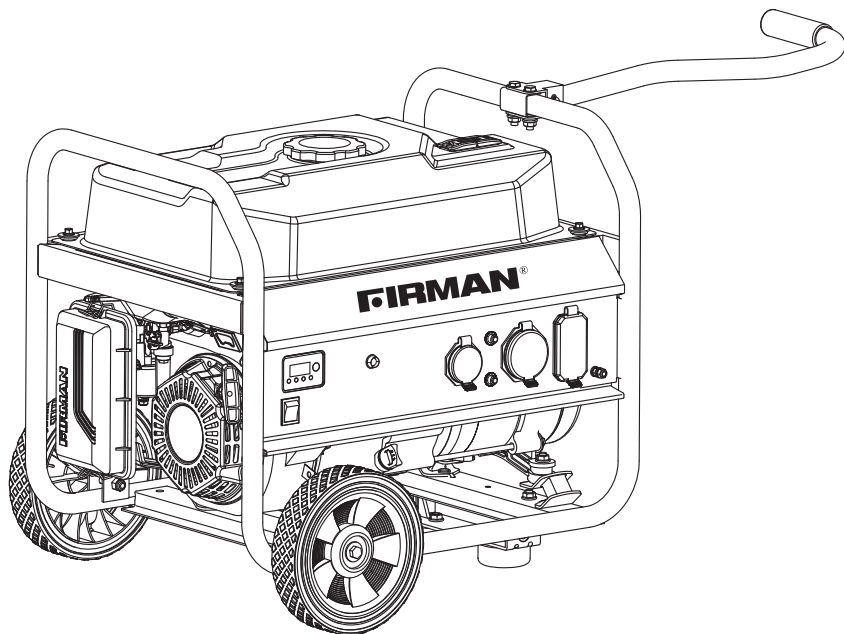

MODEL NUMBER
P03613
Rev Level:00

Record product information to reference when ordering parts or obtaining warranty coverage.

STOP DO NOT RETURN TO STORE!

CALL US FIRST
1-844-347-6261

FOR QUESTIONS OR SERVICE INFORMATION

SERIAL NUMBER: _____

PURCHASE DATE: _____

INTRODUCTION

Table of Contents

Introduction	1
Features and Controls	5
Operation	10
Maintenance - Storage	20
Troubleshooting- Specifications	26
Parts Diagrams - Parts Lists - Wiring Diagram	28
Service - Warranty	33

REGISTER YOUR PRODUCT

Register your FIRMAN generator online at www.firmanpowerequipment.com



INTRODUCTION

Thank you for purchasing a FIRMAN generator. You have selected a high-quality, precision engineered generator set designed and tested to give you years of satisfactory service. This generator is designed to run only on unleaded gasoline. This generator is not intended for life safety support.

This manual contains safety information to make you aware of the hazards and risks associated with generator products and how to avoid them. This generator is designed and intended only for supplying electrical power for operating compatible electrical lighting, appliances, tools and motor loads, and is not intended for any other purpose. It is important that you read and understand these instructions thoroughly before attempting to start or operate this portable generator. Save these original instructions for future reference.

All information in this publication is based on the latest production information available at the time of approval for printing. The manufacturer reserves the right to change, alter or otherwise improve the generator and this documentation at any time without prior notice.

SIGNAL WORDS

 DANGER	 WARNING	 CAUTION	NOTICE
Indicates a hazard which, if not avoided, will result in death or serious injury.	Indicates a hazard which, if not avoided, could result in death or serious injury.	Indicates a hazard which, if not avoided, could result in minor or moderate injury.	Indicates information considered Important, but not hazard-related.



Safety Alert Symbol- Indicates a potential personal injury hazard.



Operator's Manual- Failure to follow warnings, instructions and operator's manual could result in death or serious injury.



Toxic Fumes- Engine exhaust contains carbon monoxide, a poisonous gas that will kill you in minutes. You cannot smell it or see it.



Generator could cause electrical shock resulting in death or serious injury.



Fire- Fuel and its vapors are extremely flammable which could cause burns or fire resulting in death or serious injury. Engine exhaust could cause fire resulting in death or serious injury.



Hot Surface- Muffler could cause burns resulting in serious injury.

INTRODUCTION



WARNING! This product can expose you to chemicals including gasoline engine exhaust, which is known to the State of California to cause cancer, and carbon monoxide, which is known to the State of California to cause birth defects or other reproductive harm. For more information go to www.P65Warnings.ca.gov.

This outdoor generator can be used to power outdoor items using extension cords .

NOTICE If you have questions about intended use, contact FIRMAN customer service. This portable generator is designed to be used only with FIRMAN authorized parts.

System Ground

The generator neutral is floating, which means that the AC stator winding is isolated from the grounding fastener and the AC receptacle ground pins. On a floating neutral generator the AC receptacle ground pins are not functional. Electrical devices, such as a ground fault circuit interrupter (GFCI), requiring a functioning AC receptacle ground pin will not operate.

Compliance Requirements

There may be Federal or State regulations, local codes, or ordinances that apply to the intended use of the generator. Consult a qualified electrician, electrical inspector, or the local agency having jurisdiction. This generator is not intended to be used at a construction site or similar activity as defined by NFPA 70-2020 (NEC) section 590.6.

To Restore Power Using Extension Cords

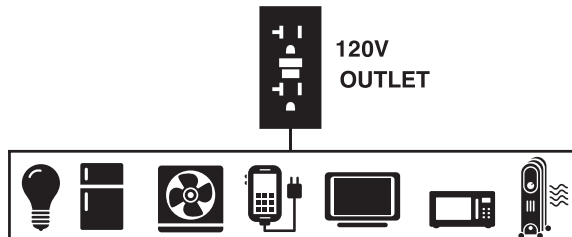

1. Only use grounded cords marked for outdoor use rated for your loads.

Total Amperage	Minimum Gauge, Outdoor Rated
	Up to 50 FT (15m)
Up to 13A	16
Up to 15A	14
Up to 20A	12
Up to 30A	10



To provide power using extension cords

2. Follow cord safety instructions.

3. Install carbon monoxide alarm(s).

4. When operating portable generator with extension cords, make sure portable generator is located in an open, outdoor area, at least 20 ft. (6 m) from occupied spaces with exhaust pointed away.

5. Extension cords running directly into your home, powering indoor items IS NOT RECOMMENDED.



DANGER! Engine exhaust contains carbon monoxide, a poisonous gas that will kill you in minutes. You cannot smell it, see it, or taste it. Even if you do not smell exhaust fumes, you could still be exposed to carbon monoxide gas.

- Extension cords running directly into the home increase your risk of carbon monoxide poisoning through any openings.
- If an extension cord running directly into your home is used to power indoor items, the operator recognizes that this increases the risk of CO poisoning to people inside the home and assumes that risk.

FEATURES AND CONTROLS

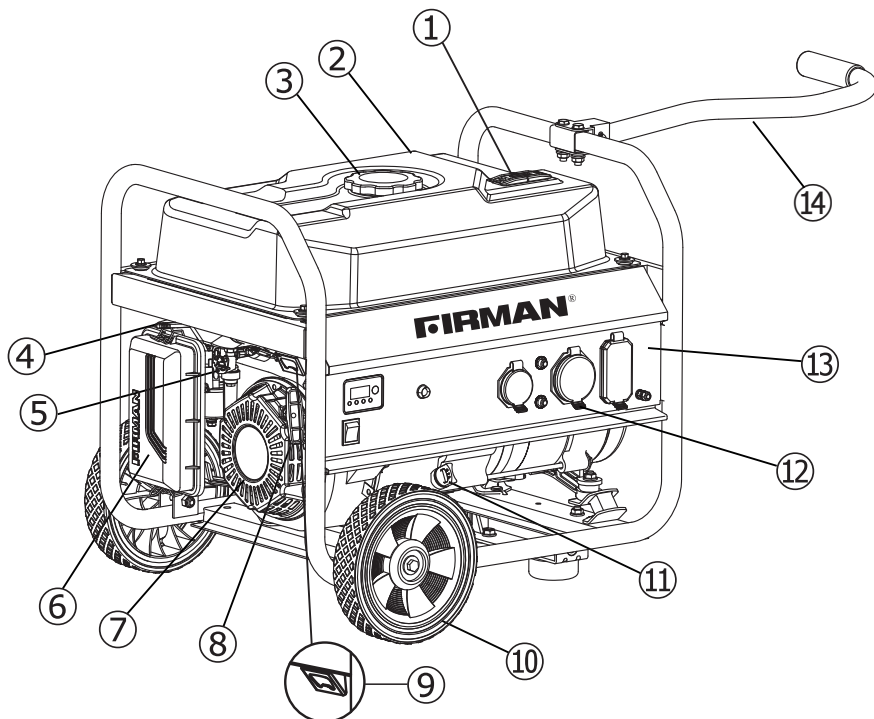

- 1- Fuel Gauge
- 2- 5.0 Gallon(19L) Capacity Fuel Tank
- 3- Fuel Cap
- 4- Choke Lever(behind air filter box)
- 5- Fuel Valve
- 6- Air Filter
- 7- 208cc FIRMAN OHV Engine
- 8- Recoil Starter
- 9- Bottle Opener
- 10- 8.0"(20.3cm) Flat Free Wheel
- 11- Oil Filler Cap
- 12- Outlet Cover
- 13- Control Panel
- 14- Handle

 Intertek 5001841 CERTIFIED TO CAN/CSA STANDARD C22.2 NO.100 FIRMAN POWER EQUIPMENT INC. 8716 W LUDLOW DR. SUITE #6 PEORIA, AZ 85381 1-844-347-6261	MODEL: P03613 REV 00		FIRMAN®	
	AC VOLTAGE:	120 V		
	AC CURRENT:	30.4 A	POWER FACTOR:	1
	DC VOLTAGE:	N/A	INSUL CLASS:	F
	DC CURRENT:	N/A	MAX AMB TEMP:	40°C (104°F)
	POWER:	3650 W	SERIAL # :	
	FREQUENCY:	60 Hz	DOM:	
	PHASE:	SINGLE		
	MADE IN CHINA FABRIQUÉ EN CHINE HECHO EN CHINA			





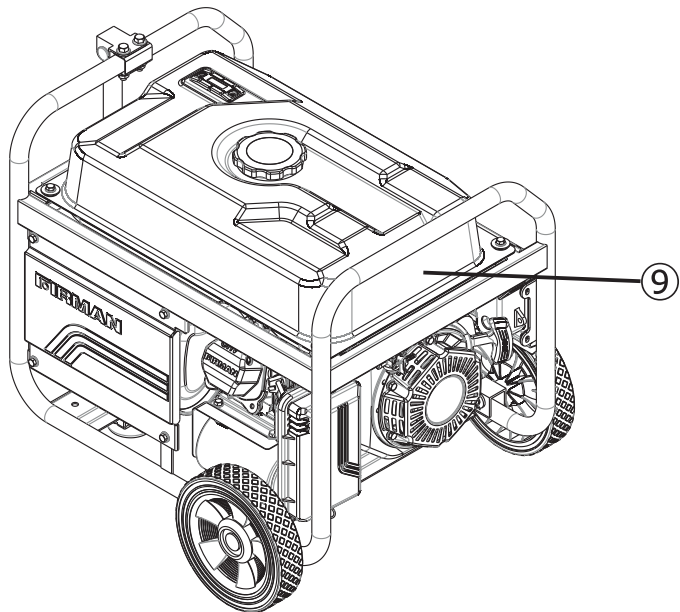
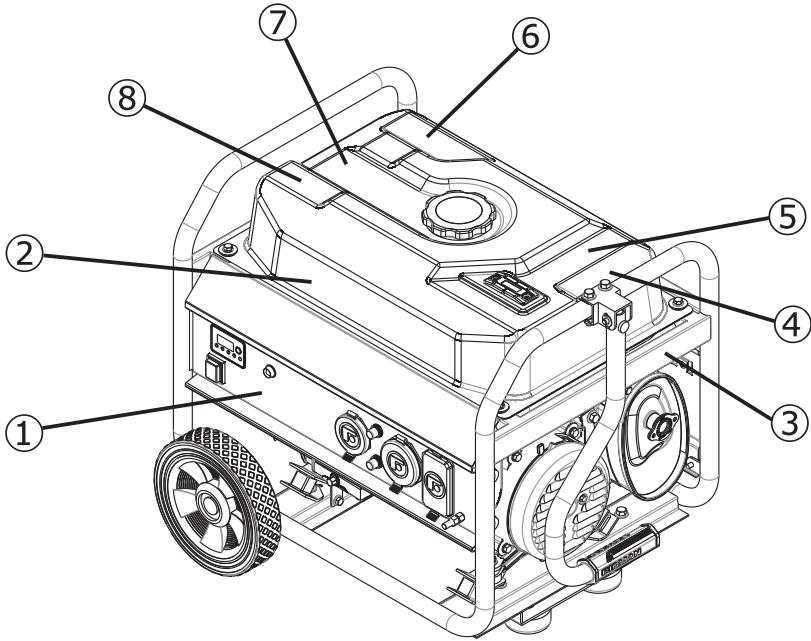

***We are always working to improve our products. Therefore, the enclosed product may differ slightly from the image on this page.**

FEATURES AND CONTROLS















FEATURES AND CONTROLS



①

 AUTOMATIC SHUTOFF - YOU MUST:	 CORTE AUTOMÁTICO - DEBE REALIZAR LO SIGUIENTE:	 ARRÊT AUTOMATIQUE - VOUS DEVEZ:
<p>MOVE GENERATOR TO AN OPEN OUTDOOR AREA, POINT EXHAUST AWAY FROM HOMES, DON'T RUN GENERATOR IN ENCLOSED AREAS (e.g. NOT IN HOUSE OR GARAGE), AIR OUT PREMISES (OPEN WINDOWS AND DOORS) BEFORE REOCCUPYING PROPERTY.</p>	<p>MUEVA EL GENERADOR A UN ÁREA ABIERTA AL AIRE LIBRE, APUNTE EL ESCAPE LEJOS DE LAS CASAS. NO UTILICE EL GENERADOR EN ÁREAS CERRADAS (EN CASA O EL GARAJE). VENTILE LAS INSTALACIONES (VENTANAS Y PUERTAS ABIERTAS) ANTES DE VOLVER A OCUPAR LA PROPIEDAD.</p>	<p>DÉPLACEZ LA GÉNÉRATRICE DANS UN ESPACE EXTÉRIEUR OUVERT, ÉLOIGNEZ L'ÉCHAPPEMENT DES MAISONS. NE FAITES PAS FONCTIONNER LA GÉNÉRATRICE DANS DES ZONES FERMÉES (P. EX. PAS DANS LA MAISON NI DANS LE GARAGE), AÉREZ LES LIEUX (FENÊTRES ET PORTES OUVERTES) AVANT DE RÉINTÉGRER LA PROPRIÉTÉ.</p>
 <p>20 FT. (PIES) (6 m) MIN.</p> 	<p>UBÍQUESE EN UN LUGAR DONDE CORRA AIRE FRESCO Y BUSQUE AYUDA MÉDICA SI SE SIENTE MAL, MAREADO O DÉBIL.</p>	<p>ALLEZ À L'AIR FRAIS ET OBTENEZ DE L'AIDE MÉDICALE EN CAS DE MALADIE, D'ÉTOURDISSEMENT OU DE FAIBLESSE.</p>
  <p>MOVE TO FRESH AIR AND GET MEDICAL HELP IF SICK, DIZZY OR WEAK.</p>		



②

 DANGER		 PELIGRO		 DANGER	
<p>Using a generator indoors CAN KILL YOU IN MINUTES. Generator exhaust contains carbon monoxide. This is a poison you cannot see or smell.</p>		<p>Utilizar un generador en interiores PUEDA PROVOCARLA MUERTE EN CUESTIÓN DE MINUTOS. Los gases del generador contienen monóxido de carbono, el cual es una sustancia venenosa que no puede verse ni olerse.</p>		<p>Utiliser un générateur à l'intérieur PEUT VOUS TUER EN QUELQUES MINUTES. Les gaz d'échappement du générateur contiennent du monoxyde de carbone. Ceci est un poison que vous ne pouvez ni voir ni sentir.</p>	
  <p>NEVER use inside a home or garage, EVEN IF doors and windows are open.</p>	 <p>Only use OUTSIDE and far away from windows, doors, and vents.</p>	  <p>No utilice NUNCA el generador en el interior de su hogar ni en un garaje, NI SIQUIERA con las puertas y ventanas abiertas.</p>	 <p>Utilice sólo AL AIRE LIBRE y lejos de ventanas, puertas y orificios de ventilación.</p>	  <p>NE JAMAIS utiliser dans un garage ou à l'intérieur, MÊME avec les portes et les fenêtres ouvertes.</p>	 <p>À n'utiliser qu'à l'EXTÉRIEUR et à distance de toutes fenêtres, portes et ouvertures.</p>



③

	 WARNING Muffler could cause burns resulting in serious injury. •Do not touch hot parts •Avoid hot exhaust gases	 ADVERTENCIA El silenciador podría causar quemaduras que ocasionen lesiones graves. •No toque las partes calientes •Evite los gases calientes del escape	 AVERTISSEMENT Le silencieux peut provoquer des brûlures et entraîner des blessures graves. •Ne touchez pas les pièces chaudes •Évitez les gaz d'échappement chauds
--	---	---	--

④

Point engine exhaust away from all occupied structures.
Mantenga los gases de escape del motor lejos de instalaciones ocupadas.
Éloignez l'échappement du moteur des structures occupées.

⑤

 	NOTICE Operate, store and transport on firm level surface. •Tilting can cause fuel spillage.	AVISO Opere, almacene y transporte en una superficie firme y nivelada. •La inclinación puede causar fugas de combustible.	AVIS Faire fonctionner, entreposer et trans porter sur une surface plane et ferme. •L'inclinaison peut provoquer des fuites de carburant.
---	---	--	--

⑥



Fuel level indicator
Indicador de nivel de combustible
Indicateur de niveau de carburant

⚠ WARNING

Fuel is flammable which could cause burns resulting in death or serious injury.

- Turn engine off and let it cool at least 2 minutes before refueling.
- Do not fill fuel above fuel level indicator.
- Never add fuel to a hot or running generator.

⚠ ADVERTENCIA

El combustible es inflamable, lo que puede causar quemaduras y provocar la muerte o lesiones graves.

- Apague el motor y déjelo enfriar al menos 2 minutos antes de repostar.
- No llene el combustible por encima del indicador de nivel de combustible.
- Nunca agregue combustible a un generador caliente o en funcionamiento.

⚠ AVERTISSEMENT

Le carburant est inflammable, ce qui pourrait provoquer des brûlures entraînant la mort ou des blessures graves.

- Arrêtez le moteur et laissezle refroidir au moins 2 minutes avant de faire le plein.
- Ne remplissez pas de carburant au-dessus de l'indicateur de niveau de carburant.
- N'ajoutez jamais de carburant à un générateur chaud ou en marche.

⑦

⚠ DANGER

 Failure to follow warnings, instructions and operator's manual will result in death or serious injury.

 Tampering with the CO ALERT system will cause Carbon Monoxide poisoning. Install Carbon Monoxide alarms inside home.

 Generator could cause electrical shock. •Do not run indoors to avoid wet conditions. •Do not run in rain or wet weather.

 Hot exhaust gases could cause fires. Keep at least 5 ft.(1.5m) clearance from any combustibles or structures, including overhead.

⚠ PELIGRO

 El incumplimiento de las advertencias, las instrucciones y el manual del operador provocará la muerte o lesiones graves.

 La alteración del sistema de alerta de CO causará envenenamiento por monóxido de carbono. Instale detectores de Monóxido de Carbono dentro de su casa.

 El generador podría producir una descarga eléctrica.

- No utilice en interiores para evitar condiciones de humedad.
- No utilice en la lluvia o en tiempo húmedo.

 Los gases calientes de salida podrían causar incendios. Manténgase a una distancia mínima de 1,5m de cualquier combustible o estructura, incluyendo lugares elevados.

⑧

⚠ DANGER

 Le non-respect des avertissements, des instructions et des manuels d'utilisation peut entraîner la mort ou des blessures graves.

 Toute altération du système COUNTY ALERT entraînera une intoxication au monoxyde de carbone. Installez des détecteurs de monoxyde de carbone à l'intérieur de la maison.

 Le générateur peut provoquer un choc électrique.

- Ne courez pas à l'intérieur pour éviter les conditions humides.
- Ne courez pas sous la pluie ou par temps humide.

 Les gaz d'échappement chauds peuvent provoquer des incendies. Gardez un dégagement d'au moins 5 pi (1,5 m) de tout combustible ou structure, y compris le plafond.

⑨

FOR RESIDENTS OF CALIFORNIA	PARA LOS RESIDENTES DE CALIFORNIA	POUR LES RÉSIDENTS DE LA CALIFORNIE
<p>⚠ WARNING: This product and the engine exhaust from this product can expose you to chemicals including CO, which are known to the State of California to cause cancer or cause birth defects and other reproductive harm. For more information, go to www.P65Warnings.ca.gov.</p>	<p>⚠ ADVERTENCIA: Este producto y el escape del motor de este producto pueden exponerlo a productos químicos, incluido CO, que en el estado de California son conocidos por causar cáncer o causar defectos de nacimiento u otros daños reproductivos. Para obtener más información, vaya a www.P65Warnings.ca.gov.</p>	<p>⚠ AVERTISSEMENT: Ce produit et l'échappement du moteur de ce produit peuvent vous exposer à des produits chimiques, y compris le CO, qui sont connus par l'Etat de Californie pour causer le cancer ou causer des malformations congénitales et autres problèmes de reproduction. Pour plus d'informations, visitez www.P65Warnings.ca.gov.</p>

FEATURES AND CONTROLS

Control Panel

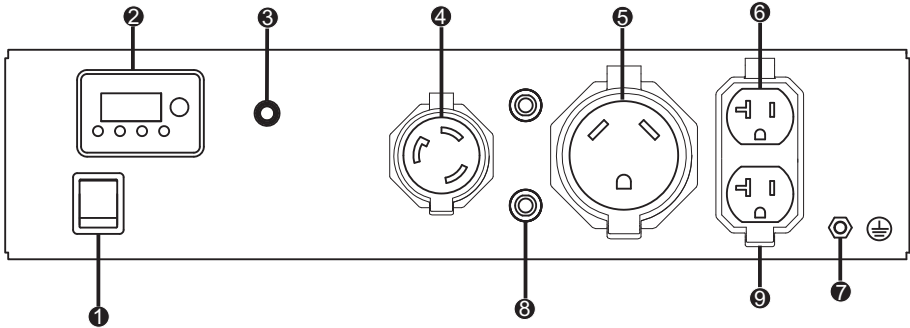

NOTICE Total power drawn from all receptacles must not exceed the name plate rating.

- 1. Engine Switch** - Engine Switch - Flip the switch to the "ON"(I) position and pull the recoil starter to start the generator. Turn to the "OFF"(O) position to turn off the generator.
- 2. 4-1 Data-Minder (Multi-Meter)** - Push the SELECT button to show the Voltage, Hertz, running hours and low oil alarm.
- 3. CO Alert™ Carbon Monoxide (CO) Shutdown Indicator Light** - Indicates the engine shutdown due to carbon monoxide accumulation around the generator or a CO Alert system fault occurred.
- 4. 120V, 30A Twist Lock** - NEMA L5-30R
A maximum of 30 Amps current may be drawn from this receptacle.
- 5. 120V, 30A RV** - NEMA TT-30R
A maximum of 30 Amps current may be drawn from this receptacle.
- 6. 120V, 20A Duplex** - NEMA 5-20R (Not GFCI protected)
A maximum of 20 Amps current may be drawn from this duplex receptacle.
- 7. Ground Terminal** - Consult an electrician or authority having jurisdiction for local grounding requirements.
- 8. Circuit Breakers** - The receptacles are protected by AC circuit protectors. If the generator is overloaded or an external short circuit occurs, a circuit protector may trip. If tripping occurs, disconnect all electrical loads and determine the cause before attempting to continue using the generator. Reset any tripped circuit protectors.
If multiple receptacles are used at the same time, the total current must be kept with-in the portable generator nameplate rating.
- 9. Outlet Cover** - Protects the receptacles from dust and debris.

1. Location



DANGER! Engine exhaust contains carbon monoxide, a poisonous gas that could kill you in minutes. You **CANNOT** smell it, see it, or taste it. Even if you do not smell exhaust fumes, you could still be exposed to carbon monoxide gas.

- Operate portable generator only outdoors, at least 20 ft. (6 m) from occupied spaces with exhaust pointed away to reduce the risk of carbon monoxide accumulating.
- Install battery-operated carbon monoxide alarms or plug-in carbon monoxide alarms with battery back-up according to the manufacturer's instructions. Smoke alarms cannot detect carbon monoxide gas.
- Do not run this portable generator inside homes, garages, basements, crawlspaces, sheds, or other partially-enclosed spaces even if using fans or opening doors and windows for ventilation. Carbon monoxide can quickly build up in these spaces and can linger for hours, even after this product has shut off.
- If you start to feel sick, dizzy, weak or your home's carbon monoxide alarm sounds, get to fresh air right away. Call emergency services. You may have carbon monoxide poisoning.

Carbon Monoxide Alarm(s)

Install carbon monoxide alarms inside your home. Without working carbon monoxide alarms, you will not realize you are getting sick and dying from carbon monoxide poisoning.

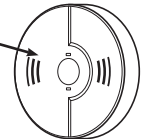

Prevent Carbon Monoxide (CO) Poisoning

Use outdoors at least 20 ft. (6 m) from any home.
Point exhaust away from all homes and occupied spaces.
Install CO alarms inside your home.



20 ft. (6 m) min.

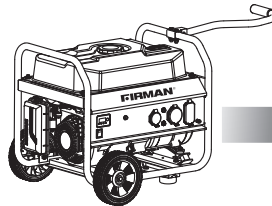

To better educate yourself about all carbon monoxide risks, go to www.takeyourgeneratoroutside.com.

OPERATION

Reduce Risk of Fire



WARNING! Exhaust heat/gases could ignite combustibles, structures or damage fuel tank causing a fire, resulting in death or serious injury.

- Keep portable generator at least 5 ft. (1.5 m) from any structure, trees or vegetation over 12 in. (30 cm) in height.
- Select an outdoor site that is dry and protected from the weather. Do not move portable generator indoors to protect it from the weather.
- Do not locate the portable generator under a deck or other similar structure that may confine heat and airflow.

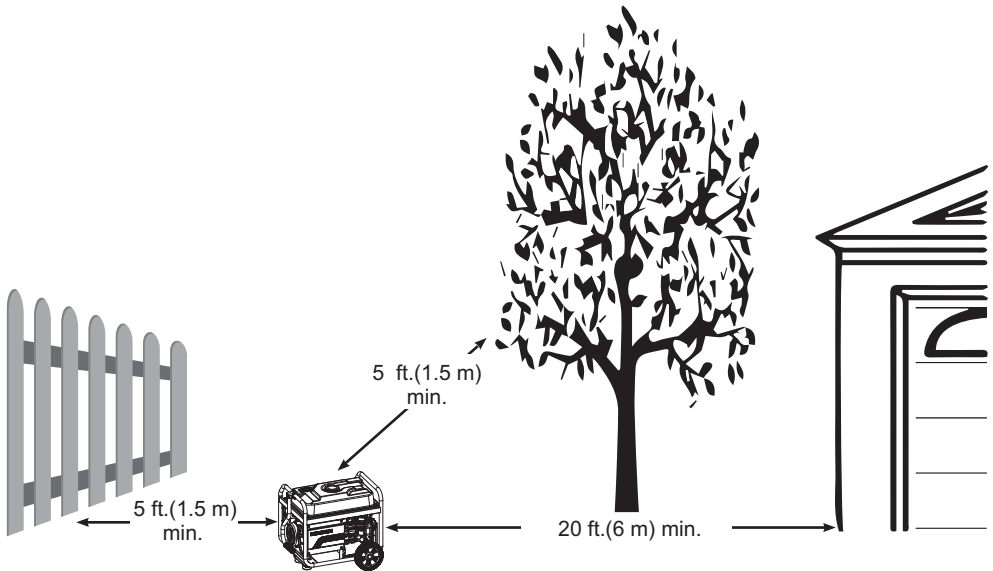

2. Oil and Gasoline

Add Engine Oil

We recommend using FIRMAN SAE 10W-30 API SL oil for best performance. Other high-quality detergent oils (API SL or higher) are acceptable. Do not use special additives. Ambient temperature determines the proper oil viscosity for the engine. Use the chart to select the proper oil for the outdoor temperature range expected.

NOTICE Do not attempt to crank or start the engine before it has been properly filled with the recommended type and amount of oil. Damage due to operation with no oil will void your warranty.

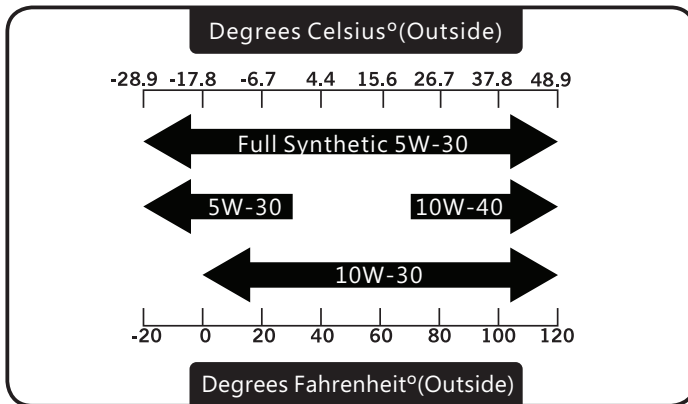

1. Place generator on a flat, level surface.
2. Clean area around oil fill and remove yellow oil fill cap/dipstick.
3. Wipe dipstick clean.

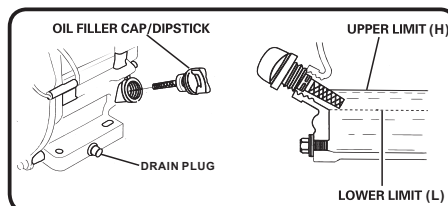
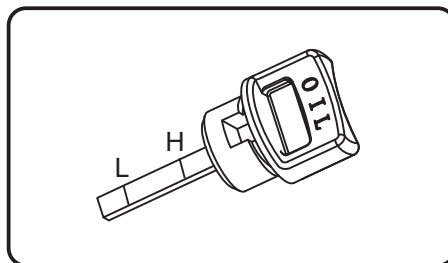

OPERATION

4. Using oil funnel, slowly pour contents of provided oil bottle into oil fill opening until oil reaches upper limit "H" mark on the dipstick. Be careful not to overfill. Overfilling could cause engine starting problems or engine damage.

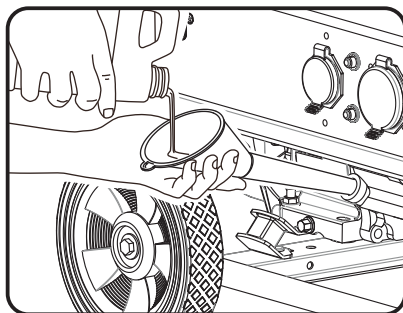

5. Replace oil fill cap/dipstick and fully tighten.

6. Oil level should be checked prior to each use or at least every 8 hours of operation. Keep oil level maintained.

Low Oil Shutdown

The portable generator is equipped with a low oil shutdown. If the oil level drops below the minimum required level, a sensor will activate an internal switch stopping the engine. If the engine shuts off and the oil level is within specifications, check to see if generator is sitting at an angle. Place portable generator on an even surface to correct this. If engine fails to start, the oil level may not be high enough to deactivate the internal low oil level switch. Make sure the sump is completely full of oil to the upper limit (H). Do not operate engine until oil level issue is corrected. Contact Firman customer service.

Add Gasoline



WARNING! Fuel and its vapors are extremely flammable which could cause burns or fire resulting in death or serious injury.

- Turn generator engine OFF and let it cool at least 2 minutes before removing fuel cap.
- Do Not refuel or move generator when engine is running.
- Move generator outdoors prior to adding or draining fuel
- Keep fuel away from any ignition sources.
- Do not overfill tank, allow space for fuel expansion.
- If any fuel spills, wait until it evaporates before starting engine
- Check and replace fuel lines, tank, cap, and fittings prior to each use if any damage or leaks are found.

Fuel must meet these requirements:

- Clean, fresh, unleaded gasoline with a minimum of 87 octane.
- For high altitude use, see Operation at High Altitude.
- Gasoline with no more than 10% ethanol is acceptable.

E10

E15

NOTICE Do not mix oil in gasoline or modify engine to run on alternate fuels not described in this manual. Use of unapproved fuels could damage engine and will not be covered under warranty.

1. Clean area around fuel fill cap, remove cap.
2. Slowly add unleaded fuel to fuel tank. Be careful not to fill above the RED fuel level indicator. This allows adequate space for fuel expansion.

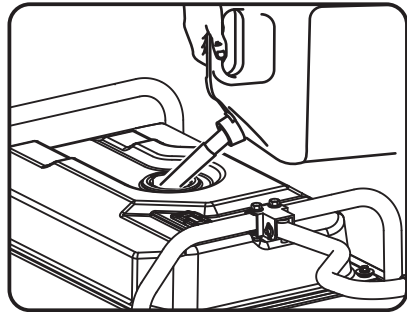
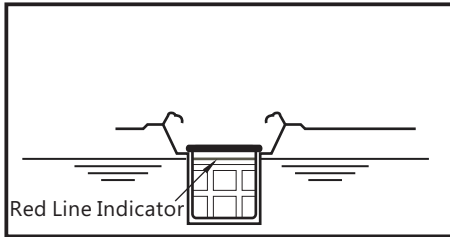

3. Install fuel cap and let any spilled fuel evaporate before starting engine.

Operation at High Altitude

At altitudes over 5,000 feet (1524 meters), a minimum 85 octane gasoline is acceptable. Engine power and generator output will be reduced approximately 3.5% for every 1000 feet (305 m) of elevation above sea level. High altitude may cause hard starting, increased fuel consumption and sparkplug fouling. To operate at high altitudes FIRMAN can provide a high altitude carburetor main jet. The alternative main jet and installation instructions can be obtained by contacting Customer Support.

	208cc	Altitude
Altitude main jet 1	335717002	3000-6000Feet
Altitude main jet 2	335717003	6000-8000Feet

NOTICE Operation using an alternative main jet at elevations lower than the recommended minimum altitude can damage the engine. For operation at lower elevations, the standard main jet supplied must be used. Operating the engine with the wrong main jet may increase exhaust emissions, fuel consumption and reduce performance.

Operation at High Ambient conditions

Your Firman Power Equipment product is designed and rated for continuous operation at ambient temperatures up to 104°F (40°C). The generator may be operated at temperatures ranging from 5°F(-15°C) to 122°F(50°C) for short periods. If the generator is exposed to temperatures outside this range during storage, the generator should be brought back within this range before operation. When operated above 77°F(25°C) there may be a decrease in power. Maximum wattage and current are subject to and limited by such factors as ambient temperature, altitude, engine conditions etc.

OPERATION

3. Starting the Generator

1. Before starting the generator, check for loose or missing parts and for any damage which may have occurred during shipment. Ensure spark plugs, muffler, fuel cap, and air cleaner are all in place.
2. Move portable generator outdoors to safe operating location at least 20 feet from any occupied spaces.
3. Disconnect all electrical loads from the generator. Never start or stop the generator with electrical devices plugged in.

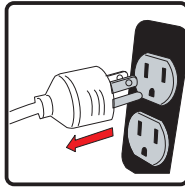

4. Turn the fuel valve to the "ON" (I) position.

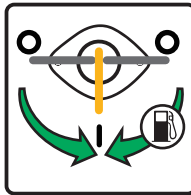

5. Flip the engine switch to the "ON" (I) position.



6. Move the choke lever to the "START" position.

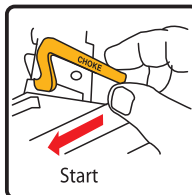

7. Pull the starter cord slowly until resistance is felt and then pull rapidly.

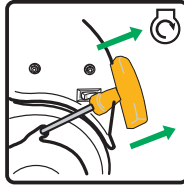

8. Do not over-choke. As soon as engine starts and warms up, move the choke lever to the “RUN” position.

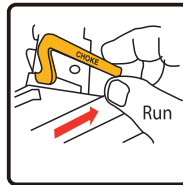

9. Allow portable generator to run at no load for a few minutes to stabilize before plugging in any electrical devices.

NOTICE If engine starts but fails to run, or if portable generator shuts down during operation, check oil level. See Low Oil Shutdown section for more information.

OPERATION

4. Connecting Electrical Loads

This portable generator has been pretested and adjusted to handle its full capacity. The voltage is regulated using an automatic voltage regulator (AVR) . Readjusting the AVR will void warranty.



WARNING! Generator voltage could cause electrical shock or burn resulting in death or serious injury.

- Damaged or overloaded extension cords could overheat, arc, and burn resulting death or serious injury.
 - Use a ground fault circuit interrupter (GFCI) in any damp or highly conductive area, such as metal decking.
 - Do not touch bare wires or receptacles.
 - Do not use generator with electrical cords which are worn, frayed, bare or otherwise damaged.
 - Do not operate generator in the rain or wet weather.
 - Do not run indoors to avoid wet conditions.
 - Do not handle generator or electrical cords while standing in water, while barefoot, or while hands or feet are wet.
1. Ensure circuit breaker on control panel is in the closed (on) position.
 2. Start the generator with no electrical load attached.
 3. Allow the engine to run for several minutes to stabilize.
 4. Plug in and turn on the first item. It is best to attach the item with the largest load first.
 5. Allow the engine to stabilize.
 6. Plug in and turn on the next item.
 7. Allow the engine to stabilize.
 8. Repeat steps 5-6 for each additional item.

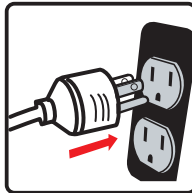

Surge Protection

There is a remote chance that voltage fluctuations may impair the proper functioning of some sensitive electronic equipment. Electronic devices, including computers and many programmable appliances may use components that are designed to operate within a narrow voltage range and may be affected by the portable generator's momentary voltage fluctuations. While there is no way to prevent all voltage fluctuations, you can take steps to protect your sensitive electronic equipment. Install a plug-in surge suppressor on the receptacles feeding your sensitive equipment. Surge suppressors come in single or multi-outlet styles. They are designed to protect against short duration voltage fluctuations.

CO Alert™

Carbon Monoxide (CO) Shutdown System

CO Alert automatically shuts down the engine when harmful levels of carbon monoxide accumulate around the generator or a CO Alert fault occurs. After shutdown, the CO Alert indicator light will blink for at least five minutes per the chart below.

CO Alert DOES NOT replace carbon monoxide alarms.

Install battery-powered carbon monoxide alarm(s) in your home. Don't run generator in enclosed areas.

Color	Description
<p>Red •••••</p>	<p>Carbon monoxide accumulated around generator. Prior to restart move generator to an open, outdoor area 20 ft. (6 m) from occupied spaces with exhaust pointed away. Air out premises (open windows and doors) before reoccupying property. Automatic shutoff is an indication generator was improperly located.</p> <p>If you start to feel sick, dizzy, weak, or your homes carbon monoxide alarm sounds while using this product, get to fresh air right away. Call emergency services. You may have carbon monoxide poisoning.</p>
<p>Yellow •• ••</p>	<p>CO Alert fault occurred*. See FIRMAN authorized service dealer.</p>

*Yellow light will blink for five seconds at the startup of generator to show CO ALERT is functioning properly.

5. Stopping the generator

1. Turn off and remove all electrical loads.

Never stop the generator with electrical devices plugged in and turned on.

Never stop the engine by moving the choke to the start position.

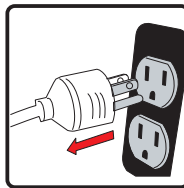

Let the generator run at no-load for one minute to stabilize internal temperatures of the engine and generator.

OPERATION

2. Flip the engine switch to "OFF"(O) position.



Do not leave the generator until it has completely stopped.

3. Turn the fuel valve to the "OFF"(O) position.

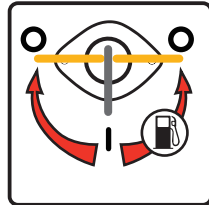

If a cover is used, do not install until unit has cooled.

MAINTENANCE SCHEDULE

ITEM	NOTES	Daily(Before operation)	Initial 25 hours	Every 50 hours	Every 100 hours (or annual)	Every 250 hours
Spark Plug	Check condition. Adjust gap and clean. Replace if necessary.				✓	
Engine Oil	Check oil level.	✓				
	Replace.		✓		✓	
Air Filter	Clean, replace if necessary.			✓		
Fuel	Clean fuel tank strainer. Replace if necessary.				✓	
Fuel Line	Check fuel hose for cracks or other damage. Replace if necessary.	✓				
Exhaust System	Check for leakage. Retighten or replace gasket if necessary.	✓				
	Check spark arrester screen. Clean/Replace if necessary.				✓	
Engine	Check adjust valve clearance. *					✓
	Clean combustion chamber. *					✓
Fittings/ Fasteners	Check. Replace if necessary.				✓	

* To be performed by knowledgeable/experienced owner or by authorized service center.

General Recommendations

Regular maintenance will improve the performance and extend the life of the generator. See any authorized dealer for service.

The generator's warranty does not cover items that have been subjected to operator abuse or negligence. To receive full value from the warranty, the operator must maintain the generator as instructed in this manual.

Some adjustments will need to be made periodically to properly maintain your generator.

All service and adjustments should be made at least once each season. Follow the requirements in the maintenanc shedule chart above.

NOTICE Once a year you should clean or replace the spark plug and replace the air filter. New spark plug and clean air filter assure proper fuel-air mixture and help your engine run at peak performance and last longer.

Maintenance - Storage

When Transporting Generator

Transport with fuel tank EMPTY or with fuel valve in OFF position.
Do not tip generator at an angle which causes fuel to spill.

ENGINE MAINTENANCE

To prevent accidental starting, remove and ground spark plug wires before performing any service.

Change Engine Oil

Change engine oil every 100 hours. (for a new engine, change oil after 25 hours.)

If you are using your generator under extremely dirty or dusty conditions, or in extremely hot weather change the oil more often.

CAUTION! Avoid prolonged or repeated skin contact with used motor oil. Used motor oil has been shown to cause skin cancer in certain laboratory animals. Thoroughly wash exposed areas with soap and water.



KEEP OUT OF REACH OF CHILDREN. DON'T POLLUTE. CONSERVE RESOURCES. RETURN USED OIL TO COLLECTION CENTERS.

(a) On a level surface drain oil into a suitable container by removing the drain plug and the oil filler cap while the engine is warm.

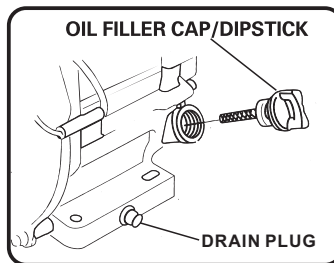

(b) Reinstall the drain plug and fill the engine with oil until it reaches the HIGH(H) level on the oil filler dipstick.

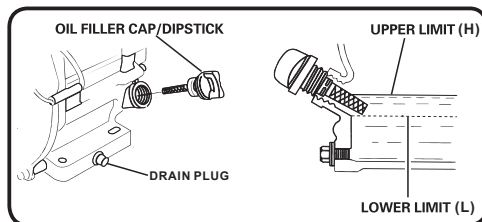
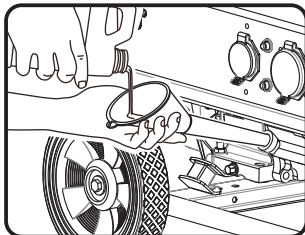

NOTICE We recommend using FIRMAN SAE 10W-30 API SL oil for best performance. Other high-quality detergent oils (API SL or higher) are acceptable. See *Oil and Gasoline*

Air Filter Maintenance

(a) Carefully remove foam air filter element and wash it with liquid detergent and water only. Squeeze dry in a clean cloth.

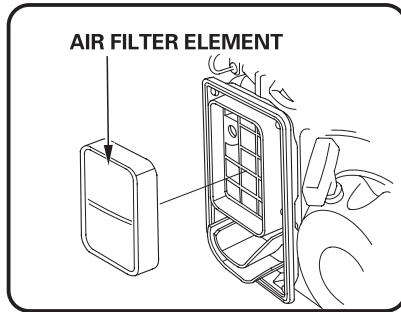
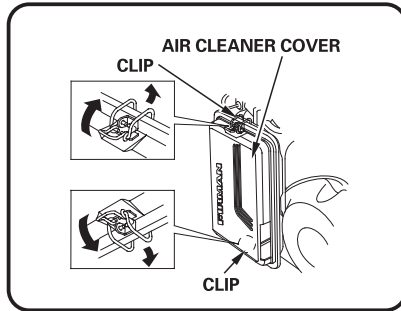

(b) Saturate foam air filter element with clean engine oil and squeeze in a clean cloth to remove excess oil.

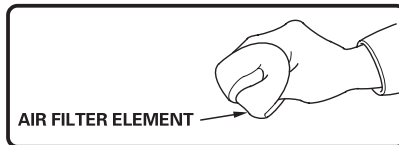

(c) Reinstall clean or new air filter element.

Spark Plug Maintenance

Changing the spark plug will help your engine start easier and run at peak performance.

(a) Remove the spark plug boot.

(b) Remove spark plug using provided wrench.

Maintenance - Storage

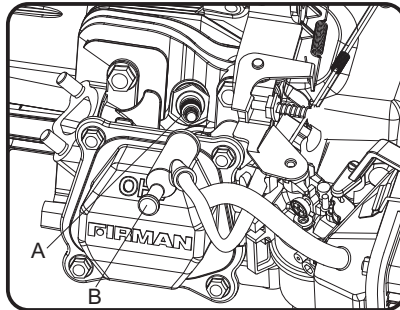

A- Spark plug
B- Spark plug boot

- (c) Inspect spark plug for damage and clean with a wire brush before reinstalling. Replace if damaged.
- (d) Adjust the electrode gap to 0.028 - 0.031 in. (0.7 - 0.8 mm).
- (e) Seat spark plug in position and thread by hand to prevent cross threading.
- (f) Tighten plug with provided wrench and put the spark plug boot back on spark plug.

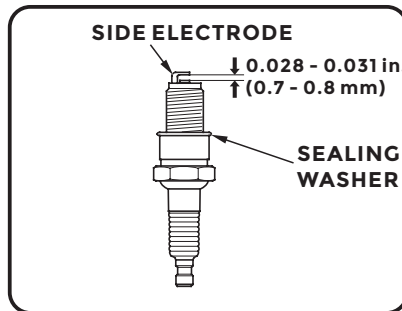

SPARK PLUG: TORCH F6RTC, NGK BPR6ES, CHAMPION RN9YC or equivalent.

Maintenance Valve Clearance

Intake: 0.004 - 0.006 in. (0.10 - 0.15 mm)

Exhaust: 0.004 - 0.006 in. (0.10 - 0.15 mm)

NOTICE Tech bulletin regarding the valve adjustment procedure is on www.firmanpowerequipment.com.

Muffler and Spark Arrester



WARNING! Contact with muffler area could cause burns resulting in serious injury.

- Do not touch hot parts.
- It is a violation of California Public Resource Code, Section 4442, to use or operate the engine on any forest-covered, brush-covered, or grass-covered land unless the exhaust system is equipped with a spark arrester, as defined in Section 4442, maintained in effective working order. Other states or federal jurisdictions may have similar laws, reference Federal Regulation 36 CFR Part 261.52.

Inspect Muffler and Spark Arrester

1. Inspect the muffler for cracks, corrosion, or other damage.
2. Remove the screws securing the spark arrester in place and then remove it from the muffler.

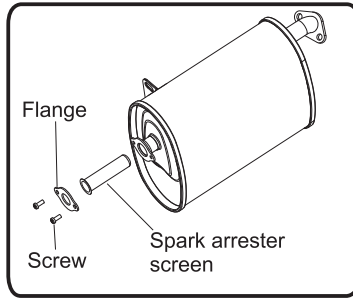

3. Carefully remove the carbon deposits from the spark arrester screen with a wire brush.

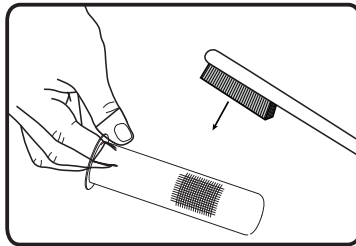

4. Replace the spark arrester if it is damaged. If replacement parts are required, make sure to use only FIRMEN original equipment replacement parts.
5. Position the spark arrester in the muffler and attach with the screws.

NOTICE Failure to clean or replace spark arrester may result in decreased engine performance.

GENERATOR MAINTENANCE

Run the generator at least 30 minutes every month.

Make certain that the portable generator is kept clean and dry.

Do not expose the unit to excessive dust, dirt, moisture or corrosive vapors.

Do not insert any objects through cooling slots.

Before each use inspect underneath the generator for signs of oil or fuel. Clean any accumulated debris. Keep area around muffler free from any debris. Use a soft bristle brush to remove dirt or caked on oil. Use a damp cloth to clean all exterior surfaces.

Long Term Storage

It is important to prevent gum deposits from forming in essential fuel system components such as the carburetor, fuel hoses or tank during storage. Ethanol-blended fuels (called gasohol, ethanol or methanol) attract moisture, which leads to separation and formation of acids during storage. Acidic gas can damage the fuel system of an engine while in storage.

When the generator set is being stored for more than one month, follow these instructions to avoid engine problems:



WARNING! Fuel and its vapors are extremely flammable which could cause burns or fire resulting in death or serious injury.

Do not store fuel near any ignition sources.

When draining fuel move generator outdoors and use a commercially available non-conductive vacuum siphon. Fuel must be drained into an approved container.

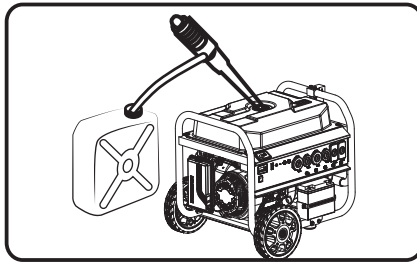

1-Treat any stored fuel with fuel stabilizer.

2-When storing generator with gasoline in fuel tank, operate the engine for 5-10 minutes to circulate treated fuel into fuel lines and carburetor before shutdown.

3- There is no need to drain gasoline from the generator fuel tank if fuel stabilizer is added.

4-FUEL STARVATION: If you elect to drain fuel tank move generator outdoors. Once fuel tank is drained turn fuel valve to on position. Start and run the portable generator outdoors until engine stops from lack of gasoline. This will drain remaining gasoline from tank, fuel lines, and carburetor.

5-Always turn fuel valve to OFF position prior to storage.

6-Allow the portable generator to cool before cleaning and storage.

7-Change oil .

8-Remove spark plug boot and spark plug. Pour about one teaspoon of engine oil through the spark plug hole, then slowly pull the recoil starter several times to distribute the oil in the cylinder. Pull recoil slowly until resistance is felt. This will close the valves so no moisture enters the engine cylinder. Reinstall the spark plug and attach the spark plug boot.

9-Cover the portable generator and store in a clean, dry place out of direct sunlight and away from any ignition sources.

Any damage or hazards caused by using improper fuel, improperly stored fuel, and/or improperly formulated stabilizers, are not covered by manufacturer's warranty.

Do not store gasoline from one season to another season.

Troubleshooting - Specifications

Problem	Cause	Correction
Engine is running, but no AC output is available.	<ol style="list-style-type: none"> 1. Circuit breaker is open. 2. Fault in generator. 3. Poor connection or defective cord set. 4. Connected device is bad. 	<ol style="list-style-type: none"> 1. Reset circuit breaker. 2. Contact authorized service facility. 3. Check and repair. 4. Connect another device that is in good condition.
Engine runs good at no-load but "bogs down" when loads are connected.	<ol style="list-style-type: none"> 1. Short circuit in a connected load. 2. Engine speed is too slow. 3. Shorted generator circuit. 4. Clogged or dirty fuel filter. 	<ol style="list-style-type: none"> 1. Disconnect shorted electrical load. 2. Contact authorized service facility. 3. Contact authorized service facility. 4. Clean or replace fuel filter.
Engine will not start; starts and runs rough or shuts down when running.	<ol style="list-style-type: none"> 1. Fuel selector switch set to OFF (O) position. 2. Low oil level. 3. Dirty air cleaner. 4. Out of gasoline. 5. Stale gasoline. 6. Spark plug wire not connected to spark plug. 7. Bad spark plug. 8. Water in gasoline. 9. Flooded. 10. Excessively rich fuel mixture. 11. Clogged or dirty fuel filter. 	<ol style="list-style-type: none"> 1. Set fuel selector switch to "ON" (I) position. 2. Fill crankcase to proper level or place generator on level surface. 3. Clean or replace air cleaner. 4. Fill fuel tank with gasoline. 5. Drain fuel tank and carburetor; fill with fresh gasoline. 6. Connect wire to spark plug. 7. Replace spark plug. 8. Drain gas tank and carburetor; fill with fresh gasoline. 9. Wait 5 minutes and re-crank engine. 10. Contact authorized service facility. 11. Clean or replace fuel filter.
Engine lacks power.	<ol style="list-style-type: none"> 1. Load is too high. 2. Dirty air filter. 3. Clogged or dirty fuel filter. 4. Clogged spark arrester. 	<ol style="list-style-type: none"> 1. Don't Overload Generator 2. Replace air filter. 3. Clean or replace fuel filter. 4. Clean or replace spark arrester.
Engine "hunts" or falters.	<ol style="list-style-type: none"> 1. Carburetor is running too rich or too lean. 2. Clogged or dirty fuel filter. 	<ol style="list-style-type: none"> 1. Contact authorized service facility. 2. Clean or replace fuel filter.
Engine shuts down when running.	<ol style="list-style-type: none"> 1. Out of gasoline. 2. Dirty air cleaner. 3. Low oil level. 	<ol style="list-style-type: none"> 1. Fill fuel tank with gasoline. 2. Clean or replace air cleaner. 3. Fill crankcase to proper level or place generator on level surface.
Engine shuts down and yellow CO fault light blinking.	<ol style="list-style-type: none"> 1. CO system fault 	<ol style="list-style-type: none"> 1. Contact authorized FIRMAN service facility.

For all other issues, contact authorized dealer or Firman customer service.

Troubleshooting - Specifications

SPECIFICATIONS

Model	P03613
Starting Watts	4550
Running Watts*	3650
Rated AC Voltage	120V
Rated Frequency	60Hz
Phase	Single
Voltage Regulator	AVR
Power Factor	1
Alternator Type	Brushed
Engine	FIRMAN
Engine Type	Single Cylinder, 4-Stroke OHV Air Cooled
Displacement	208cc
Low Oil Shutdown	Yes
Ignition System	Breakless Ignition Type, Flywheel Magneto
Starting System	Recoil
Fuel	Unleaded Automotive Gasoline
Capacity Fuel Tank	5 U.S. Gallons (19L)
Lubricating Oil Capacity	20.3 oz (0.6L)
Carburetor Type	Float
Air Cleaner	Polyurethane Type
P.T.O. Shaft Rotation	Counter Clockwise (Facing P.T.O.)
Oil Type	See "Add Engine Oil" Section
AC Grounding System	Floating Neutral

*Generator certified in accordance with CSA (Canadian Standards Association) standard C22.2 No. 100-14, Motors and Generators and complies with PGMA (Portable Generator Manufacturers' Association) standard ANSI/PGMA G300-2018, Safety and Performance of Portable Generators.

PARTS DIAGRAM AND PART LIST

P03613 PARTS DIAGRAM

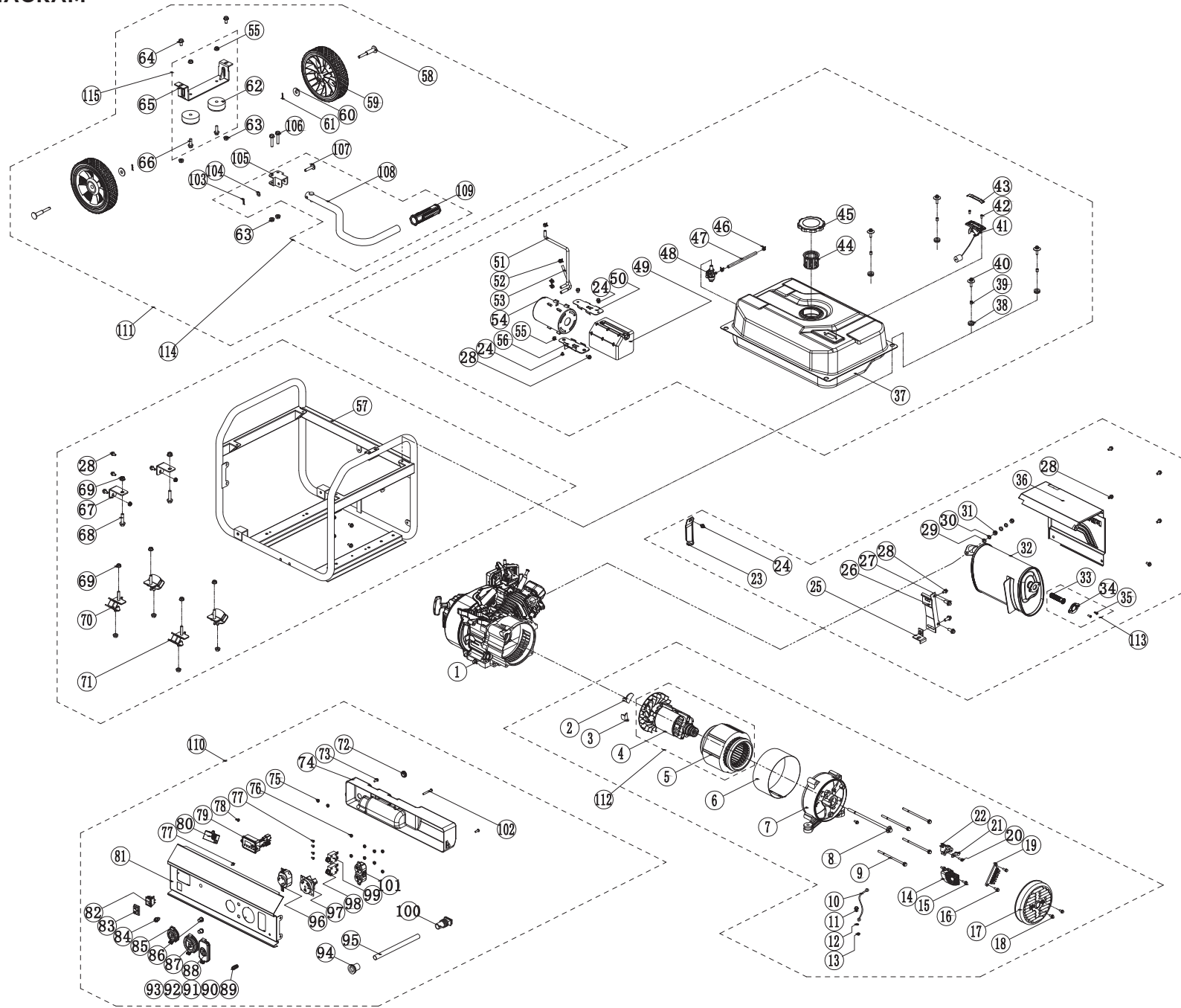

208cc ENGINE PARTS DIAGRAM

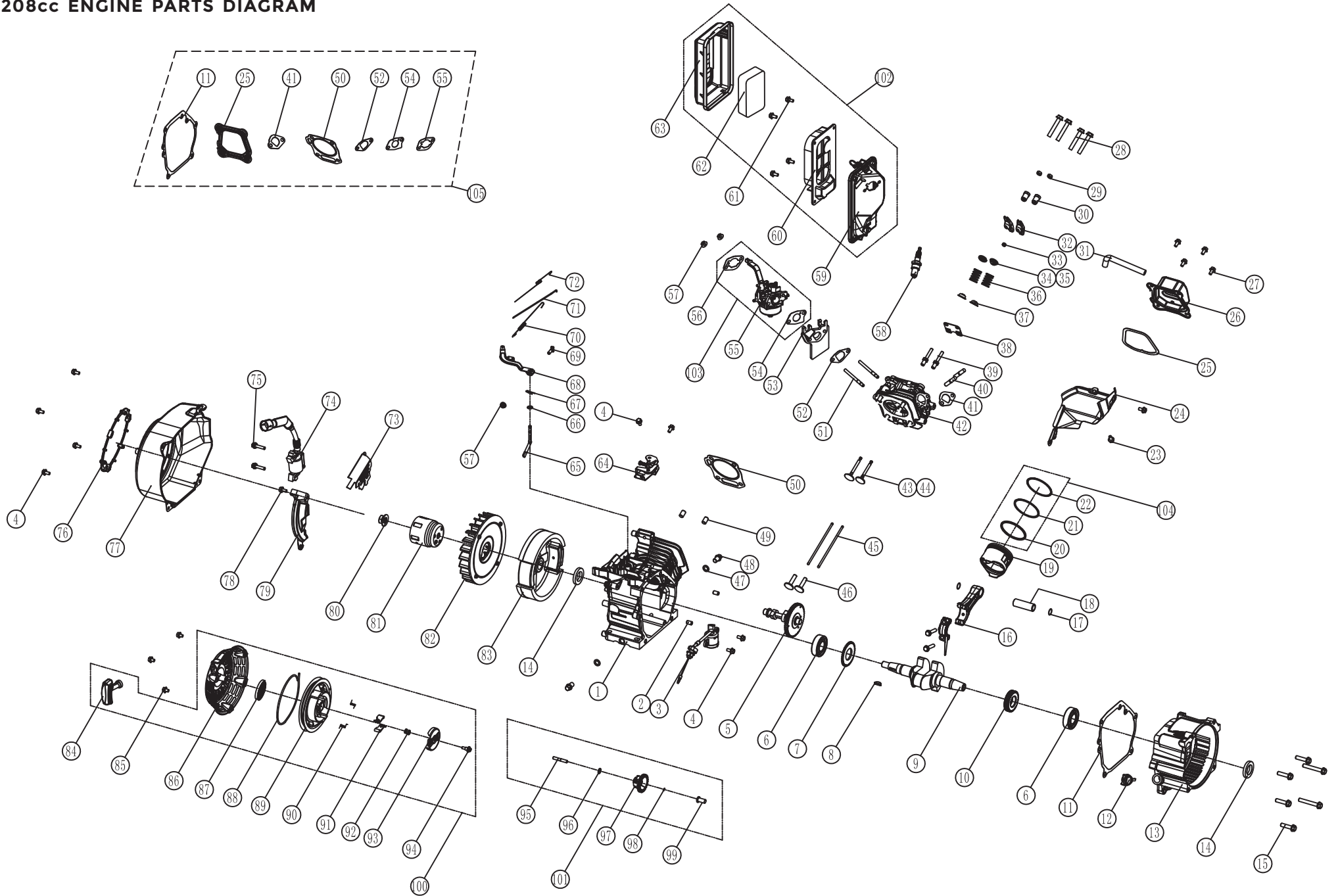

Parts Diagrams - Parts Lists - Wiring Diagram

P03613 Portable Generator

NO.	Part Number	Description	Qty.	NO.	Part Number	Description	Qty.
1	336465000	208cc Firman Engine	1	62	336713557	Rubber, Support	2
2	336713501	Rubber Cap 2	1	63	336713558	Nut M8	4
3	336713502	Rubber Cap1	1	64	336713559	Flange Bolt M8×16	2
4	336713605	Stator Assy	1	65	336713560	Support Leg	1
5	336713604	Rotor Assy	1	66	336713561	Flange Bolt M6×25	2
6	336713801	Stator Cover	1	67	336715000	Generator Fender Bracket	2
7	336713506	Generator End Cover	1	68	336715001	Flg. Bolt M8×35	2
8	336713508	Flange Bolt M8×252	1	69	336713558	Nut M8	10
9	336713511	Flange Bolt M6×179	4	70	336713562	Isolator 1	2
10	336713514	Ground Wire	1	71	336713563	Isolator 2	2
11	336713515	Flange Bolt M6×12	1	72	336713564	Sheath, Breather Tube	1
12	336713516	External Teeth Lock Washer Ø6	1	73	336713565	Screw M5×14	2
13	336713517	Nut M6	1	74	336713566	Control Box	1
14	336713518	AVR	1	75	336713567	Nut M3	2
15	336713519	Flange Bolt M5×16	2	76	336713568	Nut M4	8
16	336713520	Bolt & washer Assemblies	2	77	336713569	Screw&washer Assy M4×8	5
17	336713521	Generator End Cover Cap	1	78	336715002	Screw&washer Assy M5×14	1
18	336713507	Flange Bolt M5×12	3	79	336713570	Multi Meter	1
19	336713523	Terminal Block	1	80	336755000	Control Module	1
20	336713524	Bolt & washer Assemblies	1	81	336415001	Control Panel Comp.	1
21	336713525	Carbon Brush Holder	1	82	336713572	Engine Switch	1
22	336713526	Carbon Brush Assembly	1	83	336755004	Engine Switch Cover	1
23	336713527	Air Cleaner Bracket	1	84	336755002	CO Shutdown Indicator Light	1
24	336713528	Flange Bolt M6×8	4	85	336713573	Outlet Cover L5-30R	1
25	336713529	Muffler Fixed Plate I (small)	1	86	336755005	Breaker Cover	1
26	336713530	Muffler Fixed Plate II (big)	1	87	336713574	Outlet Cover TT-30R	1
27	336713531	Flange Bolt M8×20	3	88	336713575	Outlet Cover 5-20R	1
28	336713515	Flange Bolt M6×12	13	89	336713576	Flange Bolt M5×16(ground)	1
29	336713533	Flat Washer Ø8	2	90	336713577	Nut M5(ground)	1
30	336713509	Spring Washer Ø8	2	91	336713578	Nut M5	1
31	336713534	Nut M8	2	92	336713579	Flat Washer Ø5	2
32	336713535	Muffler Assembly	1	93	336713580	Star Washer Ø5	1
33	336713536	Arrester, Spark	1	94	357713545	Grommet	1
34	336713537	Holder, Spark Arrester	1	95	336713582	Sleeve	1
35	336713538	Screw&washer Assy M5×14	2	96	336713832	Receptacle L5-30R	1
36	336713552	Guard, Muff.	1	97	336713584	Receptacle TT-30R	1
37	336713701	Fuel Tank Assy.	1	98	330713594	AC 20A Breaker, Push Button	1
38	336713542	Grommet, Fuel Tank	4	99	336713586	Circuit Breaker	1
39	357713600	Bushing	4	100	336713587	Grommet	1
40	310715064	Bolt M6×20	4	101	336713588	Receptacle 5-20R	1
41	336713545	Fuel Gauge Assy.	1	102	336713589	Screw&washer Assy M5×38	1
42	336713546	Screw M5×10	2	103	336713590	Pin, Shaft	1
43	336713547	Fuel Gauge Display	1	104	336713591	Flat Pad (ø8.2×ø17×0.8)	1
44	336713548	Fuel Filter, Wire Mesh	1	105	336713592	Bracket, Handle	1
45	336713549	Fuel Cap	1	106	336713593	Flange Bolt M8×45	2
46	336713540	Clamp Ø8×6	5	107	340713004	Pin, Handle	1
47	336713550	Fuel hose	1	108	336713595	Handle	1
48	336713551	Fuel Valve	1	109	336713596	Cover, Handle	1
49	336713636	Carbon Canister Board I	1	110	336455000	Control Panel Assy.	1
50	336713639	Carbon Canister Board II	1	111	336413501	Portability Kit	1
51	336713635	Fuel hose	1	112	336413507	Rotor And Stator Set	1
52	330713509	Clamp Ø8.7×8	1	113	336413503	Spark Arrester Kit	1
53	336713680	Fuel hose	1	114	336413508	Handle Assembly	1
54	336713637	Carbon Canister	1	115	336413509	Support Leg Assembly	1
55	336713517	Nut M6	5				
56	336713650	Carbon Canister Holder	1				
57	336713640	Frame	1				
58	336713554	Axle Pin	2				
59	336713555	Wheel	2				
60	336713510	Flat Washer Ø8	2				
61	336713556	Cotter Pin	2				

Parts Diagrams - Parts Lists - Wiring Diagram

FIRMAN 208cc Engine

NO.	Part Number	Description	Qty.	NO.	Part Number	Description	Qty.
1	336723500	Crankcase Comp.	1	62	336723560	Element, Air Cleaner	1
2	330723511	Locating Pins	2	63	336723561	Cover, Air Cleaner	1
3	336723502	Sensor, Engine Oil	1	64	336723562	Control Assembly	1
4	336723503	Flg. Bolt M6×12	8	65	336723563	Shaft, Governor Arm	1
5	336723504	Gear Assy, Governor	1	66	336723564	Rocker Shim	1
6	336723505	Bearing	2	67	336723565	Pin, Shaft	1
7	336723506	Gear,crankshaft	1	68	336723566	Arm, Governor	1
8	336723507	Woodruff Key	1	69	336723567	Bolt,governor Arm	1
9	336723508	Crankshaft	1	70	336723568	Spring,governor	1
10	336723509	Gear,drive	1	71	336723569	Rod, Governor	1
11	336723510	Gasket, Crankcase	1	72	336723570	Spring, Throttle Valve Returning	1
12	336723511	Oil Dipstick Assy	1	73	336723572	Wind Deflectors	1
13	336723512	Cover,crankcase	1	74	336765009	Ignition Coil	1
14	336723513	Seal, Oil	2	75	357723569	Bolt	2
15	336723514	Flg. Bolt M8×32	6	76	336723575	Protect Circle	1
16	336723515	Rod, Connecting	1	77	336723576	Fan Cover Comp	1
17	336723516	Clip, Piston Pin	2	78	336723577	Flg. Bolt M6×20	1
18	336723517	Pin, Piston	1	79	336723578	Air Guide, Right Side	1
19	336723518	Piston	1	80	336723580	Locknut	1
20	336723519	Ring Set, Oil	1	81	336723581	Pulley,starter	1
21	336723520	Ring, The Second	1	82	336723582	Cooling Fan	1
22	336723521	Ring, The First	1	83	336723583	Flywheel Comp	1
23	336723522	Flg. Bolt M6×8	2	84	357723577	Grip,starter	1
24	336723523	Air Guide Lower	1	85	329713551	Bolt M6×15	3
25	336723524	Gasket, Cylinder Head Cover	1	86	336723585	Case Comp.,recoil Starter	1
26	336723525	Cover Subassembly, Cylinder Head	1	87	336723586	Spring,starter Return	1
27	336723526	Flg. Bolt M6×15	4	88	336723587	Cord	1
28	336723527	Flg. Bolt M8×55	4	89	336723588	Pulley, recoil Starter	1
29	336723528	Nut, Valve Lock	2	90	336723589	Spring,patchet	2
30	336723529	Nut, Valve Adjusting	2	91	336723590	Patchet,starter	2
31	336723530	Breather Tube	1	92	336723592	Clip Sprg.,pawl Guide	1
32	336723531	Rocker, Valve	2	93	336723591	Pawl Guide	1
33	336723532	Rotator, Valve	1	94	336723593	Screw,pawl Guide	1
34	336723533	Retainer, Intake Valve	1	95	336723594	Gov.,gear Shaft	1
35	336723534	Retainer, Exhaust Valve	1	96	336723595	Inner Washer,gear	1
36	336723535	Spring, valve	2	97	336723596	Gear, Governor	1
37	336723536	Oil Seal, valve	2	98	336723597	Clip, Governor Gear	1
38	336723538	Plate Subassembly, Lifter Stopper	1	99	336723598	Bushing, Governor Gear	1
39	336723537	Bolt, Valve Adjusting	2	100	336423500	Recoil Starter Set	1
40	336723539	Exhaust Valves Stud Bolt	2	101	336423501	Governing Gear Set	1
41	336713532	Exhaust Gasket	1	102	336423502	Air Cleaner Set	1
42	336723540	Head Subassembly, Cylinder	1	103	336423503	Carburetor Set	1
43	336723541	Valve,in.take	1	104	336423504	Piston Rings Set	1
44	336723542	Valve, Exhaust	1	105	336423507	Gasket Set	1
45	336723543	Push Rod	2				
46	336723544	Tappet, Valve	2				
47	336723545	Washer,drain Bolt	2				
48	336723546	Bolt, Drain Plug	2				
49	330723548	Locating Pins	2				
50	336723548	Gasket, Cylinder Head	1				
51	336723549	Stud, Intake	2				
52	336723550	Gasket, Inlet	1				
53	336723551	Plate, Carburetor Insulator	1				
54	336723552	Gasket, Carburetor	1				
55	336723553	Carburetor	1				
56	336723554	Gasket, Air Cleaner	1				
57	336723555	Nut M6	3				
58	336723556	Spark Plug	1				
59	336723557	Elbow, Air Cleaner	1				
60	336723558	Clapboard	1				
61	336723559	Mounting Bolt, Air Cleaner	4				

Wiring Diagram

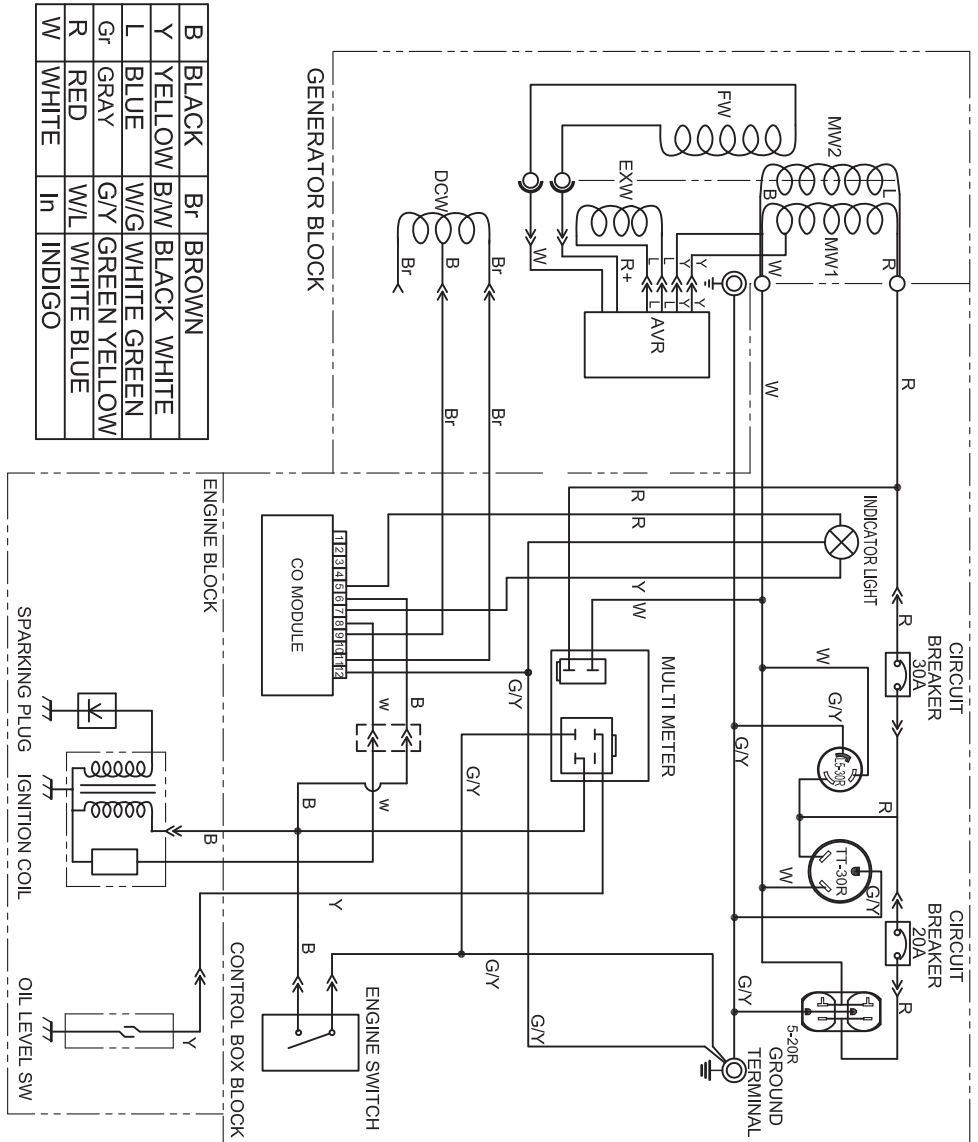

Service - Warranty

SERVICE INFORMATION CONTACT FIRMAN PRODUCT SERVICE DEPARTMENT AT 1-844-347-6261 or at www.firmanpowerequipment.com to obtain warranty service information or to order replacement parts or accessories.

HOW TO ORDER REPLACEMENT PARTS

Even quality-built equipment such as this electric generator may need occasional replacement parts to maintain it in good condition over the years. To order replacement parts, please give the following information:

- Model No. Rev. Level and Serial No.
- Parts number or numbers as shown in the Parts List section.
- A brief description of the trouble with the generator.

FIRMAN 3 Years Limited Warranty

Warranty Qualifications

FIRMAN GENERATOR will register the warranty upon receipt of your Warranty Registration Card and a copy of your sales receipt from one of FIRMAN's retail locations as proof of purchase. Please submit your warranty registration and your proof of purchase within ten(10) days of the date of purchase.

Repair/Replacement Warranty

FIRMAN warrants to the original purchaser that the mechanical and electrical components will be free of defects in material and workmanship for a period of one(1) year(parts and labor) and 3 years (parts and technical support) from the original date of purchase 90 days [parts and labor] and 180 days [parts] for commercial & industrial use. Transportation charges on product submitted for repair or replacement under this warranty are the sole responsibility of the purchaser. This warranty only applies to the original purchaser and is not transferable.

Do Not Return the Unit to the Place of Purchase

Contact the FIRMAN Service Center and FIRMAN will troubleshoot any issue via phone or e-mail. If the problem is not corrected by this method, FIRMAN will, at its option, authorize evaluation, repair or replacement of the defective part or component at a FIRMAN Service Center. FIRMAN will provide you with a case number for warranty service. Please keep it for future reference. Repairs or replacements without prior authorization, or at an unauthorized repair facility, will not be covered by this warranty.

Warranty Exclusions

This warranty does not cover the following repairs and equipment.

Normal Wear

Your product needs periodic parts and service to perform well. This warranty does not cover repair when normal use has exhausted the life of a part or the equipment as a whole.

Installation, Use and Maintenance

This warranty will not apply to parts and/or labor if your product is deemed to have been misused, neglected, involved in an accident, abused, loaded beyond the generator's limits, modified, installed improperly or connected incorrectly to any electrical component. Normal maintenance is not covered by this warranty.

Other Exclusions

This warranty excludes:

- cosmetic defects such as paint, decals, etc.
- wear items
- accessory parts
- failures due to acts of God and other force majeure events beyond the manufacturer's control
- problems caused by parts that are not original FIRMAN parts
- units used for prime power in place of existing utility power where utility is present or in place of utility power where utility power service does not normally exist.

Limits of Implied Warranty and Consequential Damage

FIRMAN disclaims any obligation to cover any loss of time, use of this product, freight, or any incidental or consequential claim by anyone from using this product. THIS WARRANTY IS IN LIEU OF ALL OTHER WARRANTIES, EXPRESS OR IMPLIED, INCLUDING WARRANTIES OF MERCHANTABILITY OR FITNESS FOR A PARTICULAR PURPOSE.

A unit provided as an exchange will be subject to the warranty of the original unit. The length of the warranty governing the exchanged unit will remain calculated by reference to the purchase date of the original unit.

This warranty gives you certain legal rights which may change from state to state. Your state may also have other rights you may be entitled to that are not listed within this warranty.

Contact Information

You may contact FIRMAN at:

Address

Firman Power Equipment Inc.
Attn: Customer Service
8716 West Ludlow Dr. Suite #6
Peoria, AZ 85381
www.firmanpowerequipment.com

We are FIRMAN POWER - And we are here for you.

Service - Warranty

FIRMAN POWER EQUIPMENT INC. Emission Control System Warranty

CALIFORNIA AND FEDERAL EXHAUST AND EVAPORATIVE EMISSIONS CONTROL WARRANTY STATEMENT

YOUR WARRANTY RIGHTS AND OBLIGATIONS

The California Air Resources Board, US Environmental Protection Agency ("US EPA") and FIRMAN POWER EQUIPMENT INC. (FIRMAN) are pleased to explain the emissions control systems warranty on your 2020-2021 or later Small Off-Road Engine ("SORE") and engine powered equipment. In California, new equipment that use small off-road engines must be designed, built and equipped to meet the State's stringent anti-smog standards. FIRMAN must warrant the emissions control systems on your SORE and engine powered equipment for the periods of time listed below provided there has been no abuse, neglect or improper maintenance of your small off-road engine or equipment leading to the failure of the emissions control system. Your emissions control system may include parts such as the carburetor or fuel-injection system, the ignition system, catalytic converter, fuel tanks, fuel lines (for liquid fuel and fuel vapors), fuel caps, valves, canisters, filters, clamps and other associated components. Also included may be hoses, belts, connectors, and other emission-related assemblies.

Where a warrantable condition exists, FIRMAN will repair your SORE and engine powered equipment at no cost to you including diagnosis, parts and labor.

MANUFACTURER'S WARRANTY COVERAGE:

The exhaust and evaporative emissions control system on your small off-road engine and engine powered equipment is warranted for two years. If any emissions-related part on your small off-road engine and engine powered equipment is defective, the part will be repaired or replaced by FIRMAN.

OWNER'S WARRANTY RESPONSIBILITIES:

As the SORE and engine powered equipment owner, you are responsible for the performance of the required maintenance listed in your operator's manual. FIRMAN recommends that you retain all receipts covering maintenance on your SORE and engine powered equipment, but FIRMAN cannot deny warranty coverage solely for the lack of receipts or for your failure to ensure the performance of all scheduled maintenance.

As the SORE and engine powered equipment owner, you should however be aware that FIRMAN may deny you warranty coverage if your small off-road engine or engine powered equipment or a part has failed due to abuse, neglect, or improper maintenance or unapproved modifications.

You are responsible for presenting your small off-road engine and engine powered equipment to a FIRMAN distribution center or service center as soon as the problem exists. The warranty repairs shall be completed in a reasonable amount of time, not to exceed 30 days.

If you have any questions regarding your warranty rights and responsibilities, you should contact FIRMAN at 1-844-347-6261.

FIRMAN Emission Control Defects Warranty Provisions

The warranty period begins on the date the engine/equipment is delivered to an ultimate purchaser. FIRMAN warrants to the ultimate purchaser and each subsequent purchaser that the engine is:

Designed, built, and equipped so as to conform with all applicable regulations adopted by the Air Resources Board and US EPA; and Free from defects in materials and workmanship that cause the failure of a warranted part to be identical in all material respects to the part as described in the engine manufacturers application for certification.

The warranty on emissions-related parts is as follows:

- (1) Any warranted part that is not scheduled for replacement as required maintenance in the owner's manual supplied, is warranted for the warranty period stated above. If any such part fails during the period of warranty coverage, the part will be repaired or replaced by FIRMAN at no charge to the owner. Any such part repaired or replaced under the warranty will be warranted for the remaining warranty period.
- (2) Any warranted part that is scheduled only for regular inspection in the owner's manual supplied, is warranted for the warranty period stated above. Any such part repaired or replaced under warranty will be warranted for the remaining warranty period.
- (3) Any warranted part that is scheduled for replacement as required maintenance in the owner's manual supplied, is warranted for the period of time prior to the first scheduled replacement point for that part. If the part fails prior to the first scheduled replacement, the part will be repaired or replaced by FIRMAN at no charge to the owner. Any such part repaired or replaced under warranty will be warranted for the remainder of the period prior to the first scheduled replacement point for the part.
- (4) Repair or replacement of any warranted part under the warranty must be performed at no charge to the owner at a warranty station.
- (5) Notwithstanding the provisions of Subsection (4) above, warranty services or repairs must be provided by FIRMAN that are franchised to service the subject engines.
- (6) The owner must not be charged for diagnostic labor that leads to the determination that a warranted part is in fact defective, provided that such diagnostic work is performed at a warranty station.
- (7) FIRMAN is liable for damages to other engine components proximately caused by a failure under warranty of any warranted part.

(8) Throughout the emissions warranty period defined in Subsection (b)(2), FIRMAN will maintain a supply of warranted parts sufficient to meet the expected demand for such parts.

(9) Any replacement part may be used in the performance of any warranty maintenance or repairs and must be provided without charge to the owner. Such use will not reduce the warranty obligations of the manufacturer.

(10) Add-on or modified parts that are not exempted by the Air Resources Board may not be used. The use of any non-exempted add-on or modified parts by the ultimate purchaser will be grounds for disallowing a warranty claim.

The manufacturer will not be liable to warrant failures of warranted parts caused by the use of a non-exempted add-on or modified part.

PARTS COVERED BY WARRANTY

Listed below are the parts (if equipped) covered by the Federal and California Emission Control System Warranty.

1. Ignition system including: <ul style="list-style-type: none">- Spark plug- Ignition coil	4. Air induction system including: <ul style="list-style-type: none">- Intake pipe/manifold- Air cleaner
2. Fuel metering system: <ul style="list-style-type: none">- Fuel tank- Fuel cap- Fuel lines (for liquid fuel and fuel vapors) and related fittings/clamps- Fuel regulator, carburetor and internal parts.	5. Crankcase breather assembly including: <ul style="list-style-type: none">- Breather connection tube
3. Catalytic muffler assembly including: <ul style="list-style-type: none">- Exhaust manifold- Catalytic converter- Muffler gasket-pulse valve	6. Fuel tank evaporative emission control system including: <ul style="list-style-type: none">- Purge valves- Carbon canister- Vapor hoses and fitting/clamps

Limitations

This Emission Control System Warranty shall not cover any of the following:

- (a) Consequential damages such as loss of time, inconvenience, loss of use of the engine or equipment, etc.
- (b) Diagnosis and inspection fees that do not result in eligible warranty service being performed.

FIRMAN POWER EQUIPMENT INC.
www.firmanpowerequipment.com

FOLLOW US ON SOCIAL MEDIA

USE

#EVERYGENERATORTELLSASTORY™

FOR YOUR CHANCE TO WIN FIRMAN SWAG



**FIRMAN POWER EQUIPMENT INC.
8716 WEST LUDLOW DR. SUITE #6
PEORIA, AZ 85381
1-844-347-6261
WWW.FIRMANPOWEREQUIPMENT.COM**

All rights reserved. Any reprinting or unauthorized use without the written permission is expressly prohibited.
P/N:336745462 Rev:00