



www.delonghi.com

Instructions for use. Keep these instructions
Mode d'emploi. Conservez cette notice
Instrucciones para el uso. Repase y guarde estas
instrucciones. Lea cuidadosamente este instructivo antes
de usar su aparato

COFFEE MAKER
MACHINE À CAFÉ
CAFETERA

BC0320T/BC0330T



Register this product on-line and receive a free trial issue of
Cook's Illustrated. Visit www.delonghiregistration.com.
Visit www.delonghi.com for a list of service centers near you.

Enregistrez ce produit en ligne et recevez un numéro gratuit de
Cook's Illustrated. Visitez www.delonghiregistration.com.
Visitez www.delonghi.com pour y voir une liste des centres de
réparation proches de chez vous.

Registre este producto en línea y reciba un ejemplar gratis de
Cook's Illustrated. Visite www.delonghiregistration.com.
Visite www.delonghi.com para ver la lista de centros de
servicios cercanos a usted.

ELECTRIC CHARACTERISTICS: CARACTÉRISTIQUES ÉLECTRIQUES: CARACTERISTICAS ELECTRICAS:
120V-60Hz - 1 500 W



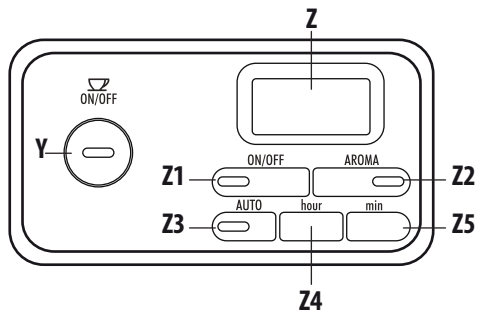
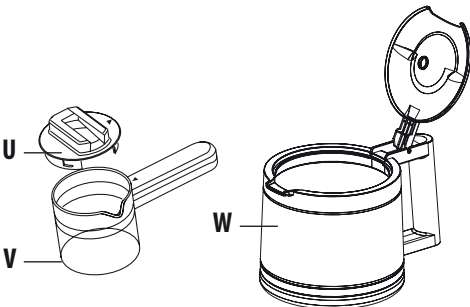
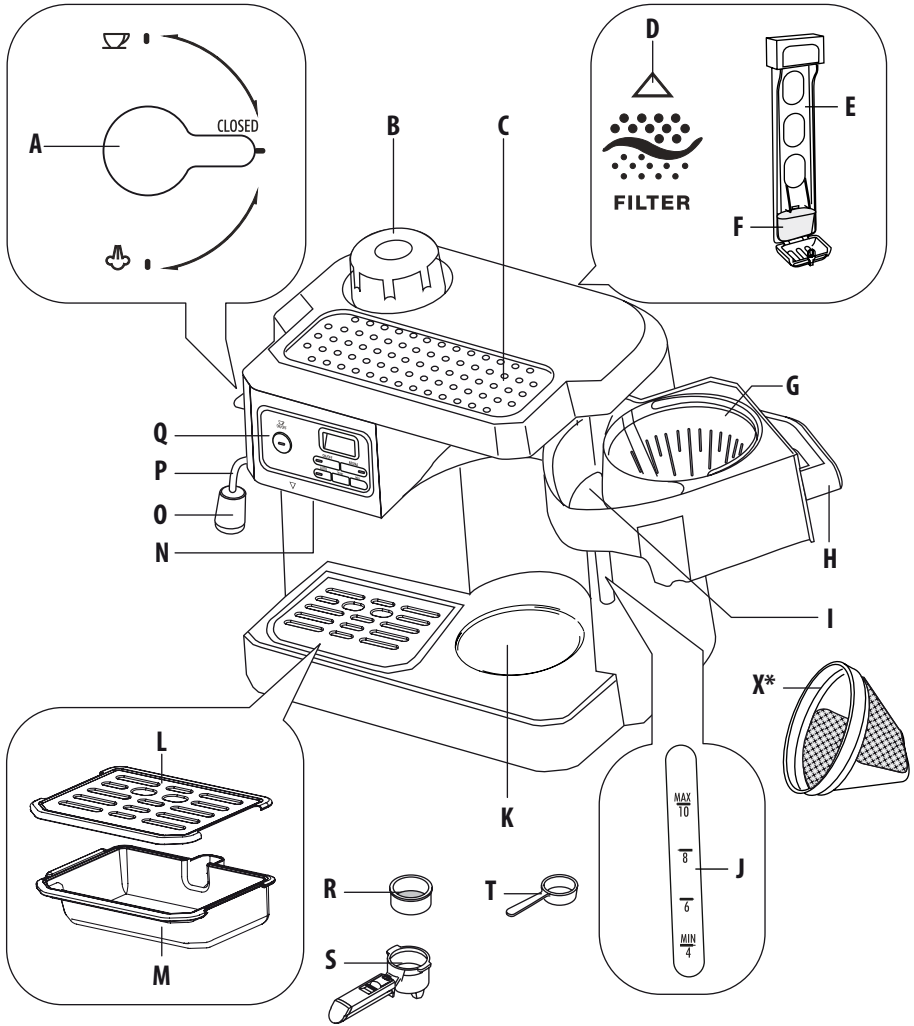

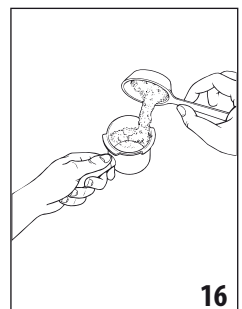
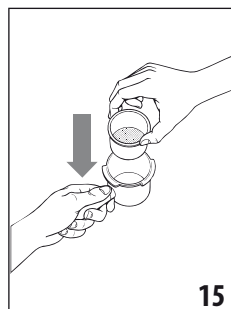
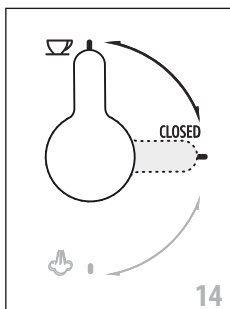
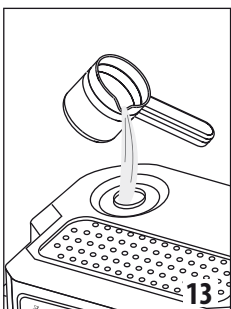
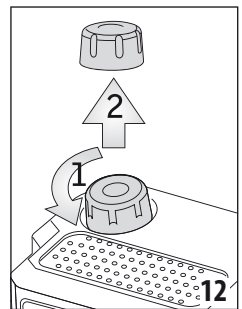
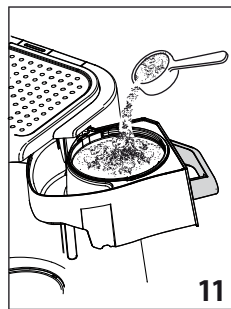
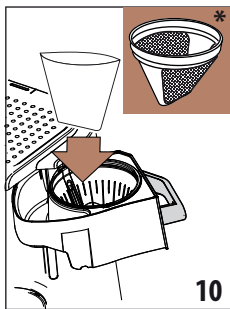
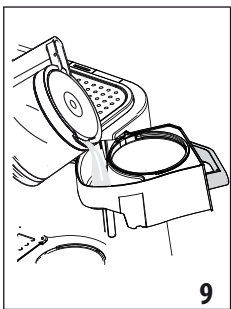
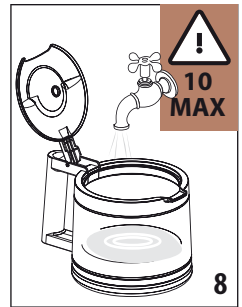
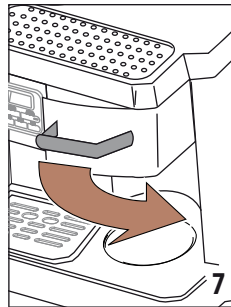
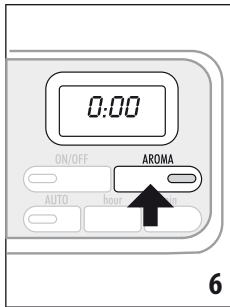
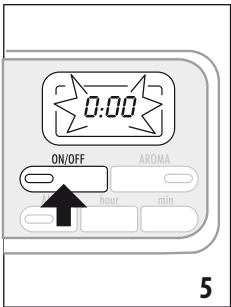
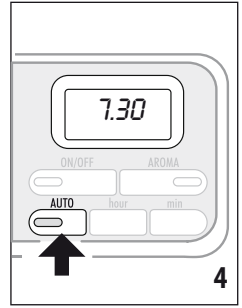
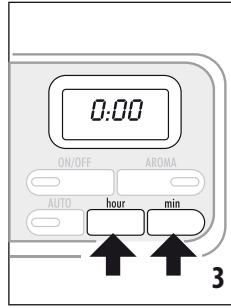
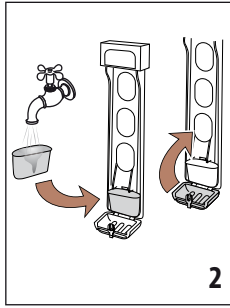
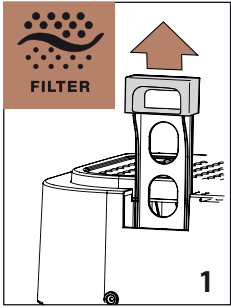

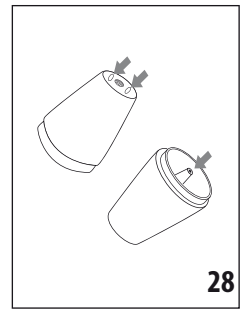
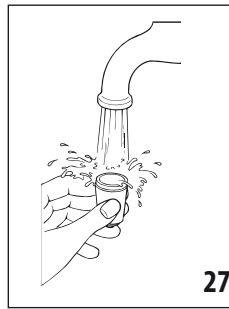
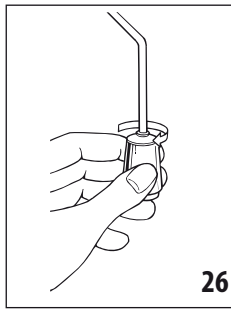
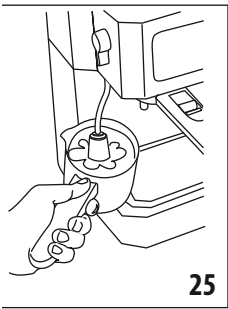
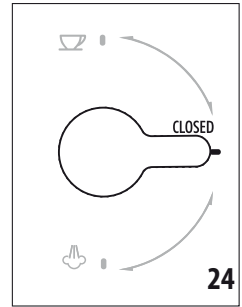
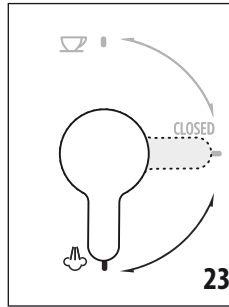
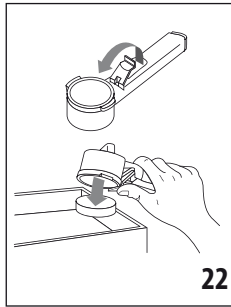
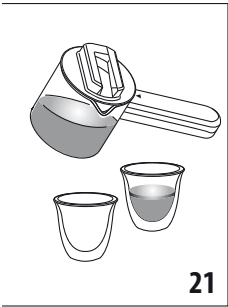
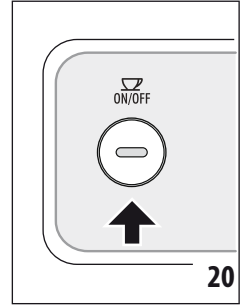
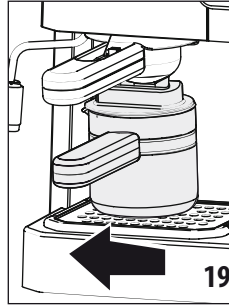
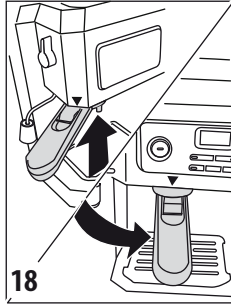
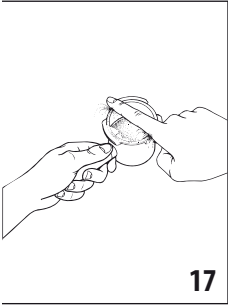

IMPORTANT SAFEGUARDS en

When using electrical appliances, basic safety precautions should always be followed, including the following:

- Read all instructions.
- Do not touch hot surfaces. Use handles and knobs.
- To protect against fire, electrical shock and personal injury, do not immerse cord, plug or appliance in water or other liquid.
- Never allow the appliance to be used by children.
- Unplug from the outlet when not in use and before cleaning. Allow to cool before fitting or taking off parts, and before cleaning the appliance.
- Do not operate with a damaged cord or plug, or after the appliance malfunctions, or has been damaged in any manner. Return the appliance to the nearest authorized service facility for examination, repair or adjustment.
- The use of accessory attachments or spare parts not recommended by the appliance manufacturer may result in fire, electrical shock or personal injury.
- Do not use outdoors.
- Do not let the cord hang over the edge of the table or counter, or touch hot surfaces.
- Do not place on or near a hot gas or electrical burner, or in a heated oven.
- Plug cord into the wall outlet. To disconnect, turn any control to "off", then remove plug from wall outlet.
- Do not use the appliance for other than the intended use. This appliance is to be utilized for domestic use only. Any other use is to be considered improper and, therefore, dangerous.
- For machines with glass carafe:
 - A. The carafe is an accessory to be used exclusively with this appliance. Never use it on a cooking surface.
 - B. Do not set the hot container on a damp or cold surface.
 - C. Do not use the carafe if it is cracked or the handle is not completely sturdy.
 - D. Do not use abrasive detergents or sponges to clean.

WARNING: To reduce the risk of fire or electric shock, do not remove the cover. Don't attempt to repair or modify the machine, doing so will void the warranty. Repair should be done by authorized service personnel only!

SAVE THESE INSTRUCTIONS

THIS PRODUCT IS FOR HOUSEHOLD USE ONLY

SHORT CORD INSTRUCTIONS

- A short power cord is provided to reduce risks resulting from becoming entangled in or tripping over a longer cord.
- Longer, detachable power supply cords or extension cords are available and may be used if care is exercised in their use.
- If an extension cord is used, the marked electrical rating should be at least as great as the electrical rating of the appliance. If the appliance is provided with 3- wire, grounding type cord, the extension should be a GROUNDING TYPE 3 - WIRE CORD. The longer cord should be arranged so that it will not drape over the counter-top or table top where it can be pulled on by children or tripped over.
- Your product is equipped with a polarized alternating current line plug (a plug having one blade wider than the other). This plug will fit into the power outlet only one way. This is a safety feature. If you are unable to insert the plug fully into the outlet, try reversing the plug. If the plug should still fail to fit, contact your electrician to replace your obsolete outlet. Do not defeat the safety purpose of the polarized plug.

Read this instruction booklet carefully before installing and using the appliance. This is the only way to ensure the best results and maximum safety for the user.

Description (see page 3)

The terminology below will be used on subsequent pages.

- A Espresso/steam knob
- B Espresso boiler cap
- C Cup storage tray
- D Antichlorine filter cover
- E Antichlorine filter support
- F Antichlorine filter
- G Filter-holder for drip coffee
- H Opening handle
- I Water filling compartment
- J Water tank level indicator
- K Warming plate
- L Cup tray
- M Drip tray
- N Boiler outlet
- O Cappuccino nozzle
- P Steam spout
- Q Control panel
- R 2-4 cups espresso filter
- S Espresso filter holder
- T Measuring spoon
- U Cover for small espresso carafe
- V Small carafe for espresso
- W Large carafe for drip coffee
- X Permanent gold tone filter (*some models only)

Control panel description

- Y On/off button for espresso coffee with power light
- Z Display
- Z1 On/off button for drip coffee with power light
- Z2 AROMA button with light
- Z3 AUTO button (automatic switch-on) for drip coffee with AUTO ON light
- Z4 HOUR button
- Z5 MIN button

When using the appliance **for the first time**, all the accessories and the internal circuits must be washed as follows:

- DRIP COFFEE MAKER: Make at least two carafes of coffee without using ground coffee.
- ESPRESSO MAKER: Make at least four cappuccinos without using ground coffee and using water instead of milk.

Safety Warnings

- This appliance is designed to “make coffee” and “hot drinks”. Use with care to avoid scalds from the water and steam jets or through incorrect use.
- Never touch hot parts.
- After removing the packaging, make sure the product is complete. If in doubt, do not use the appliance and contact a De’Longhi customer service representative.
- The packing elements (plastic bags, polystyrene foam, etc.) should be kept out of reach of children as they are a safety hazard.
- This appliance is intended for domestic use only. Any other use is considered improper and thus dangerous.
- The manufacturer cannot be held responsible for any damage caused through incorrect, wrong or unreasonable use.
- Never touch the appliance with wet or damp hands.
- Never let children use the appliance without supervision.
- Never allow children to play with the appliance.
- Should the appliance break or not function correctly, turn it off and do not tamper with it. For all repairs, contact authorized service centers only and insist on the use of original spare parts.
Failure to respect the above could reduce the safety of the appliance.
- The power cord for this appliance must not be replaced by the user as this operation requires the use of special tools. In the event of damage, contact an authorized service center only to avoid all risks.

Installation

- Place the appliance on a work surface away from water faucets and sinks.
- Check that the voltage of the outlet corresponds to the value indicated on the appliance rating plate. Connect the appliance to an efficiently grounded electrical socket with a minimum rating of 10A only. The manufacturer declines all liability for any accidents caused by the absence of an efficient ground system.
- If the plug fitted to the appliance does not match the electrical socket, have the outlet replaced with a suitable type by a qualified electrician.
- Never install the appliance in environments where the temperature may reach 0°C (32°F) or lower (the appliance may be damaged if the water freezes).

Antichlorine filter 

The filter eliminates the taste of chlorine in the water. To install the filter, proceed as follows:

- Release the filter support from its slot by pulling it upwards (fig. 1).
- Remove the Antichlorine filter from the plastic sachet and rinse it under a running tap (fig. 2).
- Open the filter support and carefully put the filter in place as shown in fig. 2.
- Close the filter container carefully (fig. 2), and reposition it in its slot, pushing it firmly downwards.
- The Antichlorine filter should be replaced after 80 cycles, and at least after every 6 months of operation.

Preparation of drip coffee**Setting the clock**

When the coffee machine is connected to the outlet for the first time, the numbers 0:00 will flash on the display.

To set the time, proceed as follows:

1. Press the "HOUR" button (Fig. 3) for about 2 seconds until the number of hours on the display begins to increase.
2. Before the display stops flashing (about 5 seconds), set the hour by pressing the HOUR button repeatedly.
3. Set the minutes by pressing the MIN button (Fig. 3) repeatedly. (To speed up the operation, hold the button down.)
4. After setting the time, wait 5 seconds. When the display stops flashing, the time set is stored.

To reset the time, press the HOUR button for about 2 seconds, and then follow the procedure as described starting from point 2.

Please note: In the event of a temporary power failure, the time set does not remain stored in the memory.

Programming the automatic start (AUTO BUTTON)

The appliance can be programmed to make drip coffee automatically.

First, make sure that the time is set correctly.

To set the delayed start (i.e. the time you want the coffee to be made), proceed as follows:

1. Press the AUTO button (Fig. 4) for about 2 seconds until 0:00 flashes on the display.
2. Before the display stops flashing (about 5 seconds), set the desired hour by pressing the HOUR button repeatedly.
3. Set the minutes by pressing the MIN button repeatedly.
4. After 5 seconds, the display will stop flashing and the programmed time will be stored.
5. After you have programmed the machine as described

above, just press the AUTO button to have coffee made at the time set (the AUTO indicator light will illuminate).

Please note:

- If you want to change the start time after it has been set, press the AUTO button for about 2 seconds and then set a new time as described starting from point 2.
- Keep in mind that at the time set, the appliance will start to make drip coffee only. The espresso maker does not come on.

Length of warming time (Automatic shut-off time)

The appliance is factory-set to keep the coffee warm for two hours after startup.

However, this setting can be changed as follows:

1. Press the ON/OFF button (Z- Fig. 5) for about 2 seconds until 0:00 flashes on the display.
2. Modify the time by repeatedly pressing the HOUR button (and also the MIN button if required).
3. After setting the time, wait 5 seconds. When the display stops flashing, the time will be stored.

Please note: If 0:00 is set, the appliance switches off. (You can set a time within 1 minute and 11 hours and 59 minutes).

Aroma

You can enhance the flavor of your coffee by pressing the AROMA button after the  ON/OFF button. This feature activates a unique brewing process, slowly releasing water into the filter basket; saturating coffee grounds a little at a time extracting the best flavor and aroma from your coffee.

To activate, press the AROMA button (fig. 6); the light on the button will illuminate.

Press the button again to turn the selection off.

It is recommended to use the aroma button when preparing 5 cups or less: do not use this button if brewing an entire carafe of coffee.

You can select this function even when using the auto function.

Making drip coffee

- Open the filter-holder door, rotating it towards the right (fig. 7).
- Fill the carafe to the level indicator relative to number of cups of coffee you wish to prepare, taking care not to exceed the MAX level (fig. 8), otherwise, in order to not overflow the machine, the excess water will spill out from the back of the unit.
- Then pour the water into the water-fill compartment of the appliance (fig. 9).
- Position the gold tone filter (if applicable), or paper filter, into the filter-holder (fig. 10).

- Put the ground coffee in the filter using the measuring spoon supplied, and level it off evenly (fig. 11). As a general rule, use a level measure of coffee (approx 7 grams) for every cup of coffee required (for example, 10 measures to obtain 10 cups).
- Close the filter-holder door and place the carafe, with cover in place, onto the warming plate.
- Press the ON/OFF button. The light on the button indicates that the drip coffee-maker is in operation.
 - The coffee will begin to dispense after a short time.

It is perfectly normal for the appliance to emit steam while the coffee is percolating.

To keep the coffee hot after the percolation process has finished, place the carafe on the hot plate and leave the machine turned on (with the drip coffee light on): the coffee in the carafe will be kept at the right temperature.

- To turn off the machine press the ON/OFF switch.

Espresso coffee

1. UnscREW the boiler cap by turning it counter-clockwise (fig. 12).
2. Fill the small carafe for espresso with the quantity of water corresponding to the number of cups you want to make (see chart on page 11).
3. Pour the water into the boiler (Fig. 13).
4. Close the boiler cap by turning it firmly clockwise.
5. Turn the espresso/steam knob to ☒ position (fig. 14).
6. Place the filter for espresso coffee into the filter-holder (Fig. 15).
7. Fill the filter with ground coffee according to the quantity shown in the chart on page 11 and distribute evenly without pressing down (Fig. 16): **never exceed the quantity described in the chart.**

It is important to use top quality medium grind coffee to avoid blocking the filter while the coffee is being dispensed.

8. Remove excess coffee from the edge of the filter (Fig. 17).
9. To attach the filter-holder, position it under the boiler outlet with the handle aligned with the triangle (Fig. 18), and push it upwards while turning the handle firmly toward the right as far as it reaches the arrow on the front side.
10. Place the small carafe for espresso under the filter-holder (Fig. 19). Make sure the filter-holder spouts are inside the opening in the carafe lid. Do not use the carafe without lid, to avoid splashes.
11. Press the ☒ ON/OFF button (fig. 20): the light on the

button comes on.

12. After about two minutes, the espresso coffee starts to run out from the filter-holder spouts.

CAUTION: To prevent splashes, never remove the filter-holder while the appliance is dispensing coffee.

13. When coffee no longer runs out of the filter-holder, press the ☒ ON/OFF button to turn the coffee maker off.
14. Pour the coffee into cups (fig. 21).
15. To dispose of the used coffee grounds, unfasten the filter-holder. Block the filter using the lever incorporated in the handle and empty the grounds by turning the filter-holder upside down and tapping (Fig. 22).

CAUTION: Before removing the filter-holder, to avoid puffs of steam, completely eliminate any residual steam in the boiler by turning the espresso/steam knob to ☒ position (Fig. 23).

NOTE: For safety reasons, when the boiler is hot the cap cannot be opened, but turns without catching. If you need to remove it for any reason, first vent all the steam in the boiler as described above.

How to make cappuccino

- To make two cappuccinos, prepare the espresso coffee as described in the section "ESPRESSO COFFEE" from point 1 to point 11, but add the quantity of water required to make two cappuccinos (see chart on page 11). (Note: the quantity of water for making cappuccinos is greater than that needed for espresso. The additional water is used to produce steam to froth the milk).
- Press the ☒ ON/OFF button (fig. 20).
- Let the coffee drip into the espresso carafe. When the darker coffee (which is below the lighter colored cream) reaches level 2 on the the carafe turn the knob to CLOSE (Fig. 24). This must be done with the utmost care. If the coffee goes above level 2, there will not be enough steam left afterward to froth the milk.
- Pour about 3.5 oz./100gr of milk for each cappuccino you want to make into a container. Use only fresh milk, not boiled and in particular not hot. When choosing the size of container to use, keep in mind that the volume of the milk will double or triple.
- Immerse the cappuccino nozzle into the milk to about 5 mm and turn the espresso/steam knob to ☒ (Fig. 25). The milk will begin to increase in volume and take on a creamy appearance. Close the espresso/steam knob only after all the steam has been released from the boiler.
- Press the ☒ ON/OFF button to turn off the machine and turn the espresso/steam knob to ☒ position.
- Pour the coffee into two sufficiently large cups.

- Pour the frothed milk slowly over the coffee with the aid of a spoon, then sprinkle a bit of cocoa powder on top for a perfect cappuccino.
- To make 4 cappuccinos, repeat the previous steps, paying attention to the quantity of water, milk and ground coffee indicated in the table in the table on page 11.

IMPORTANT: The cappuccino nozzle must always be cleaned after each use. Proceed as follows:

- Remove the cappuccino nozzle by turning it clockwise (Fig. 26) and wash it thoroughly with warm water (fig. 27).
- Check that the three holes indicated in Fig. 28 are not obstructed. Clean if necessary using a pin.
- Clean the steam spout, being careful not to burn yourself.
- Screw the cappuccino nozzle back on.

Cleaning and maintenance

- During the cleaning operation, never immerse the machine in water. It is an electrical appliance.
- Before carrying out any cleaning of the external parts of the appliance, switch off the machine, remove the plug from the change to electrical outlet and let the machine cool down.
- Do not use solvents or abrasive detergents to clean the appliance. A soft damp cloth is sufficient.
- Clean the filter-holder, drip tray, boiler outlet, carafe and water tank regularly. Never wash the filter-holder and the other accessories in the dishwasher.
- Rinse all the components and clean the espresso filter thoroughly with warm water and a small brush.
- From time to time, check to make sure the holes in the espresso filter are not obstructed. If necessary, clean using a pin.

Descaling the drip coffee section

With time, the limestone content of the water can cause obstructions which may effect the correct functioning of the appliance. It is advisable to carry out descaling of the machine after about every 40 uses. For this descaling procedure, use an appropriate descaler for filter coffee machines, available in the shops. If such a product is not obtainable, the operation can be carried out in the following way:

1. Pour 4 cupfuls of water into the drip coffee carafe;
2. Dissolve 2 spoonfuls (about 30 grams) of citric acid in the water (sold at drug stores or at grocery stores);
3. Place the drip coffee carafe onto on the hot plate;
4. Press the ON/OFF button, percolate the equivalent of a cupful and then switch off the appliance;

5. Leave the solution to act for 15 minutes. Repeat operations 4 and 5 another time.
6. Switch on the machine and continue production until the tank is completely empty.
7. Rinse out by running the appliance just using water at least three times (3 full tanks of water).

Descaling the espresso section

Over time, heating the water used to make the coffee leads to lime scale buildup in the internal circuits of the appliance.

We, therefore, recommend that you descale the espresso maker every 2-6 months (depending on the hardness of the water and the frequency of use), or, in any case, not more than 150 coffees. Proceed as follows:

1. Fill the small espresso carafe with water up to level 4 on the WATER LEVEL side.
2. Dissolve 1 spoonful (about 15-20 grams) of citric acid (sold at drug stores or at grocery stores) in the water.
3. Pour the solution into the boiler and screw on the cap.
4. Make sure the espresso/steam knob is closed and attach the filter-holder.
5. Place the small espresso carafe under the espresso filter holder.
6. After a few minutes, the solution begins to run into the carafe. Every now and then, turn the espresso/steam knob to position  to let out a little of the solution from the cappuccino nozzle.
8. When all the solution has run through, turn the appliance off and let it cool down.
9. To eliminate the descaling solution residues, repeat steps 1 to 8 at least twice, using water only (without adding citric acid).

Problem		Possible causes	Solution
CAPPUCCINO / ESPRESSO	No espresso coffee is delivered	No water in the boiler	Fill the boiler with water
		The holes in the filter holder are blocked	Clean the filter holder spout holes
		The filter is clogged.	Clean the filter and holes thoroughly using a pin
	The espresso takes longer to brew	The coffee is ground too fine, or too much coffee in the filter, or pressed coffee.	Use a different kind of coffee, put less coffee into the filter and do not press the coffee.
No milk froth is formed when making cappuccino	Milk not cold enough	Always use skim milk at refrigerator temperature.	
	Cappuccino maker dirty	Thoroughly clean the holes in the cappuccino frother	
DRIP COFFEE	The drip coffee takes longer to brew	The drip coffee machine needs to be descaled	Descalc as described in the section DESCALING THE DRIP COFFEE SECTION
	The coffee has an acidic taste	Inadequate rinsing	Rinse the appliance as described in the section DESCALING THE DRIP COFFEE SECTION
	Leaks on counter	Filled too much water	Be sure to do not fill more than the 10 cups of water as specified on fig. 8, pg.4.
	ON/OFF light does not stay on	The automatic shutoff time is set at 0.00	See section "Length of warming time"

Espresso and Cappuccino water level

To make	Water level	Quantity of ground coffee to place in the filter	Quantity of coffee before making steam
2 espressos			
2 cappuccinos			
4 espressos			
4 cappuccinos			

This warranty applies to all products with De'Longhi or Kenwood brand names.

What does the warranty cover?

We warrant each appliance to be free from defects in material and workmanship. Our obligation under this warranty is limited to repair at our factory or authorized service center of any defective parts or part thereof, other than parts damaged in transit. In the event of a products replacement or return, the unit must be returned transportation prepaid. The repaired or new model will be returned at the company expense.

This warranty shall apply only if the appliance is used in accordance with the factory directions, which accompany it, and on an Alternating current (AC) circuit.

How long does the coverage last?

This warranty runs for one year (1) from the purchase date found on your receipt and applies only to the original purchaser for use.

What is not covered by the warranty?

The warranty does not cover defects or damage of the appliance, which result from repairs or alterations to the appliance outside our factory or authorized service centers, nor shall it apply to any appliance, which has been subject to abuse, misuse, negligence or accidents. Also, consequential and incidental damage resulting from the use of this product or arising out of any breach of contract or breach of this warranty are not recoverable under this warranty. Some states do not allow the exclusion or limitation of incidental or consequential damage, so the above limitation may not apply to you.

How do you get service?

If repairs become necessary, see contact information below:

U.S. Residents: Please contact our toll free hotline at 1-800-322-3848 or log onto our website at www.delonghi.com

Residents of Canada: Please contact our toll free hotline at 1-888-335-6644 or log onto our website at www.delonghi.com

Residents of Mexico: Please contact our toll free number 01-800-711-8805 for assistance or log onto our website at www.delonghi.com

The above warranty is in lieu of all other express warranties and representations. All implied warranties are limited to the applicable warranty period set forth above. This limitation does not apply if you enter into an extended warranty with De'Longhi. Some states/countries do not allow limitations on how long an implied warranty lasts, so the above exclusions may not apply to you. De'Longhi does not authorize any other person or company to assume for it any liability in connection with the sale or use of its appliance.

How does country law apply?

This warranty gives you specific legal rights, and you may also have other rights, which vary from state to state/country to country.