

85059

**1200W 1.6HP
POST HOLE DIGGER**

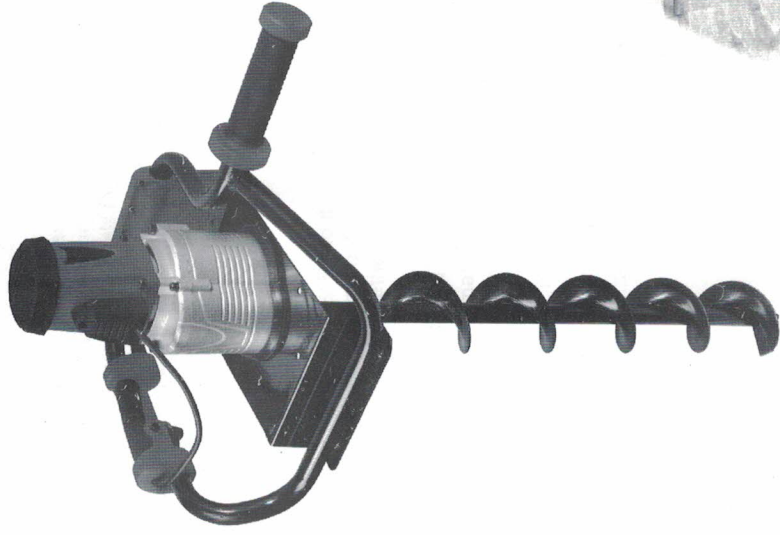

APPLIANCE

Intended use

This earth auger is intended to work with soil, (digging holes for small trees, fence ground stakes and the like.), which is designed to be used with both hand for gardening purpose.

Non intended use

This machine is not designed for working with ice, excessively rocky ground and especially in an area which with underground electric, gas, water, or telephone lines. This machine is not designed for use in any position other than the auger bit is in upright.

Residual risks

Even with the intended use of the appliance there is always a residual risk, which can not be prevented. According to the type and construction of the appliance the following potential hazards might apply:

- Access to the rotating auger bit (cutting hazards)
- Unforeseen, abrupt movement of the auger bit. (vibrating on hands)
- Flung out of foreign materials from the working area.
- Inhalation of work place particles, emissions from the gasoline engine
- Skin contact with the fuel (gasoline / oil)
- Loss of hearing, if no required ear protection used during work.



WARNING! Read this manual and general safety instructions carefully before using the appliance, for your own safety. Your power tool should only be passed on together with these instructions.

PACKAGE CONTENT LIST

- Remove all packing materials
- Remove remaining packaging and transit supports (if existing)
- Check the completeness of the packing content
- Check the appliance, the power cord, the power plug and all accessories for transportation, damages.
- Keep the packaging materials as far as possible till the end of the warranty period. Dispose it into your local waste disposal system afterwards.













WARNING Packing materials are no toys! Children must not play with plastic bags! Danger of suffocation!

- 1 x 1200W electric earth auger
- 1 x Auger bit
- 2 x Bolt
- 2 x Nut
- 1 x Hex spanner
- 1 x Manual

When parts are missing or damaged, please contact your dealer

SYMBOLS

In this manual and/or on the machine the following symbols are used:

	Warning / Danger		Caution! Always wear earmuffs!
	Read the manual carefully before use.		Caution! Always wear eye protection!
	Keep bystanders away from the danger zone!		Do not use the appliance in wet weather conditions!
	Always switch off the appliance, disconnect the power and wait till the machine comes to a standstill prior to maintenance, cleaning or repair work!		Remove plug from the mains immediately if the cable is damaged or cut
	Wear sturdy, non-slip footwear		Use protective gloves

GENERAL POWER TOOL SAFETY WARNINGS

Read all safety warnings and all instructions. Failure to follow all warnings and instructions may result in electric shock, fire and/or serious injury. Save all warnings and instructions for future reference. The term "power tool" in the warnings refers to your mains operated (corded) power tool or battery operated (cordless) power tool.

Work area

- Keep work area clean and well lit. Cluttered and dark areas invite accidents.
- Do not operate power tools in explosive atmospheres, such as in the presence of flammable liquids, gases or dust. Power tools create sparks which may ignite the dust or fumes.
- Keep children and bystanders away while operating a power tool. Distractions can cause you to lose control.

Electrical safety



Always check that the power supply corresponds to the voltage on the rating plate.

- Power tool plugs must match the outlet. Never modify the plug in any way. Do not use any adapter plugs with earthed (grounded) power tools. Unmodified plugs and matching outlets will reduce risk of electric shock.
- Avoid body contact with earthed or grounded surfaces such as pipes, radiators, ranges and refrigerators. There is an increased risk of electric shock if your body is earthed or grounded.
- Do not expose power tools to rain or wet conditions. Water entering a power tool will increase the risk of electric shock.
- Do not abuse the cord. Never use the cord for carrying, pulling or unplugging the power tool. Keep cord away from heat, oil, sharp edges or moving parts. Damaged or entangled cords increase the risk of electric shock.
- When operating a power tool outdoors, use an extension cord suitable for outdoor use. Use of a cord suitable for outdoor use reduces the risk of electric shock.
- If operating a power tool in a damp location is unavoidable, use a residual current device (RCD) protected supply. Use of an RCD reduces the risk of electric shock.

Personal safety

- Stay alert, watch what you are doing and use common sense when operating a power tool. Do not use a power tool while you are tired or under the influence of drugs, alcohol or medication. A moment of inattention while operating power tools may result in serious personal injury.
- Use safety equipment. Always wear eye protection. Safety equipment such as dust mask, non-skid safety shoes, hard hat, or hearing protection used whenever conditions require will reduce personal injuries.
- Avoid accidental starting. Ensure the switch is in the off position before plugging in. Carrying power tools with your finger on the switch or plugging in power tools that have the switch on invites accidents.
- Remove any adjusting key or wrench before turning the power tool on. A wrench or a key left attached to a rotating part of the power tool may result in personal injury.
- Do not overreach. Keep proper footing and balance at all times. This enables better control of the power tool in unexpected situations.
- Dress properly. Do not wear loose clothing or jewellery. Keep your hair, clothing and gloves away from moving parts. Loose clothes, jewellery or long hair can be caught in moving parts.
- If devices are provided for the connection of dust extraction and collection facilities, ensure these are connected and properly used. Use of these devices can reduce dust related hazards.

Power tool use and care

- Do not force the power tool. Use the correct power tool for your application. The correct power tool will do the job better and safer at the rate for which it was designed.
- Do not use the power tool if the switch does not turn it on and off. Any power tool that cannot be controlled with the switch is dangerous and must be repaired.

- Disconnect the plug from the power source before making any adjustments, changing accessories, or storing power tools. Such preventive safety measures reduce the risk of starting the power tool accidentally.
- Store idle power tools out of the reach of children and do not allow persons unfamiliar with the power tool or these instructions to operate the power tool. Power tools are dangerous in the hands of untrained users.

- Maintain power tools. Check for misalignment or sticking of moving parts, breakage of parts and any other condition that may affect the power tool's operation. If damaged, have the power tool repaired before use. Many accidents are caused by poorly maintained power tools.
- Keep cutting tools sharp and clean. Properly maintained cutting tools with sharp cutting edges are less likely to stick and are easier to control.
- Use the power tool, accessories and tool bits etc., in accordance with these instructions and in the manner intended for the particular type of power tool, taking into account the working conditions and the work to be performed. Use of the power tool for operations different from intended could lead to a hazardous situation.

Service

- Have your power tool serviced by a qualified repair person using only identical replacement parts. This will ensure that the safety of the power tool is maintained.

GUIDELINES FOR USING EXTENSION CORDS

- Make sure the extension cord is in good condition. When using an extension cord, be sure to use one that is heavy enough to carry the current that your product will draw. An undersized cord will cause a drop in line voltage, which will result in loss of power and overheating.
- Make sure your extension cord is properly wired and in good condition. Always replace a damaged extension cord, or have it repaired by a qualified person before using it. Protect your extension cords from sharp objects, excessive heat, and damp or wet areas.
- Before connecting the motor to the power line, make sure the switch is in the OFF position and the electric current is rated the same as the current stamped on the motor nameplate. Running at a lower voltage will damage the motor.



This tool must be grounded while in use in order to protect the operator from electric shock.

ASSEMBLY

- Put the auger into the output shaft of the auger bit;
- insert the bolt;
- lock it with the nut.

OPERATION

1. Before starting machine, position auger upright at desired drilling point.
2. Position feet stable and away from the auger bit.
3. Firmly grip the two handles with both hands.
4. Slowly squeeze the switch trigger to rotate the auger bit.
5. Press the handles lightly downward to drill a hole.
6. Raise the auger frequently to help clear drilling debris from the hole.
7. Overloading the auger during drilling may cause it to stop turning. When this occurs, lift the auger to reduce the drilling load on the motor, and allow drilling debris to be augered out of the hole and resume drilling.



DO NOT place excessive body weight on the machine.
DO NOT use an ice auger bit in earth or an earth auger bit in ice. A different style of auger bit is required for each type of drilling.
DO NOT use the auger in excessively rocky ground.

CLEANING AND MAINTENANCE



- Warning ! Before performing any work on the equipment, pull the power plug.
- Do not submerge earth auger in any liquids.
- Do not use products that contain ammonia, chlorine, or abrasives.
- Do not use chlorinated solvents, carbon tetrachloride, kerosene, or gasoline.
- Keep earth auger body clean. Use a soft cloth dampened with a mild soap and water mixture and wipe the earth auger body to clean.

STORAGE

- In a high or locked place, out of children's reach;
- in a dry place.

TECHNICAL DATA

Power supply voltage: 110V~ 60Hz
Power consumption: 10.9AMP
Diameter auger bit: 4 inch
Drilling depth: 560mm
Netto weight: 12.8kg

SOUND EMISSION

Noise emission values measured according relevant standards
Noise power level LWA: 90 dB(A) K = 3 dB(A)
Noise power level LPA: 102 dB(A) K = 3 dB(A)
aw (Vibration): 5.5 m/s² K = 1.5 m/s²



ATTENTION ! The sound power pressure may exceed 85 dB(A), in this case individual hearing protection must be worn.

WARRANTY

- This product is warranted as provided by law for a 24 months period effective from the date of purchase by the first user.
- This warranty covers all material or production flaws. It does not include defective parts subject to normal wear & tear such as bearings, brushes, cables, and plugs, or accessories such as drills, drill bits, saw blades, etc. ; damage or defects resulting from maltreatment, accidents or alterations; nor the cost of transportation.
- This warranty covers all material or production flaws, excluding batteries, chargers, defective parts subject to normal wear and tear such as, in particular, bearings, brushes, cables, plugs... Accessories such as drills, drill bits, saw blades etc. also do not fall under this warranty.
- Damage and/or defects resulting from inappropriate use also do not fall under the warranty provisions.
- We also disclaim all liability for any bodily injury resulting from inappropriate use of the tool.

Parts List and Diagram

- Repairs may only be carried out by an authorised customer service centre for Powerplus tools.
- Any transportation costs shall always be borne by the customer, unless agreed otherwise in writing.
- At the same time, no claim can be made on the warranty if the damage of the device is the result of negligent maintenance or overload.
- Definitely excluded from the warranty is damage resulting from fluid permeation, excessive dust penetration, intentional damage (on purpose or by gross carelessness), inappropriate usage (use for purposes for which the device is not suitable), incompetent usage (e.g. not following the instructions given in the manual), inexpert assembly, lightning strike, erroneous net voltage. This list is not exhaustive.
- Acceptance of claims under warranty can never lead to the prolongation of the warranty period nor commencement of a new warranty period in case of a device replacement.
- We reserve the right to reject a claim whenever the purchase cannot be verified or when it is clear that the product has not been properly maintained. (Clean ventilation slots, carbon brushes serviced regularly, etc.)
- Your purchase receipt must be kept as proof of date of purchase.
- Your appliance must be returned undismantled to your dealer in an acceptably clean state, (in its original blow-moulded case if applicable to the unit), accompanied by proof of purchase.

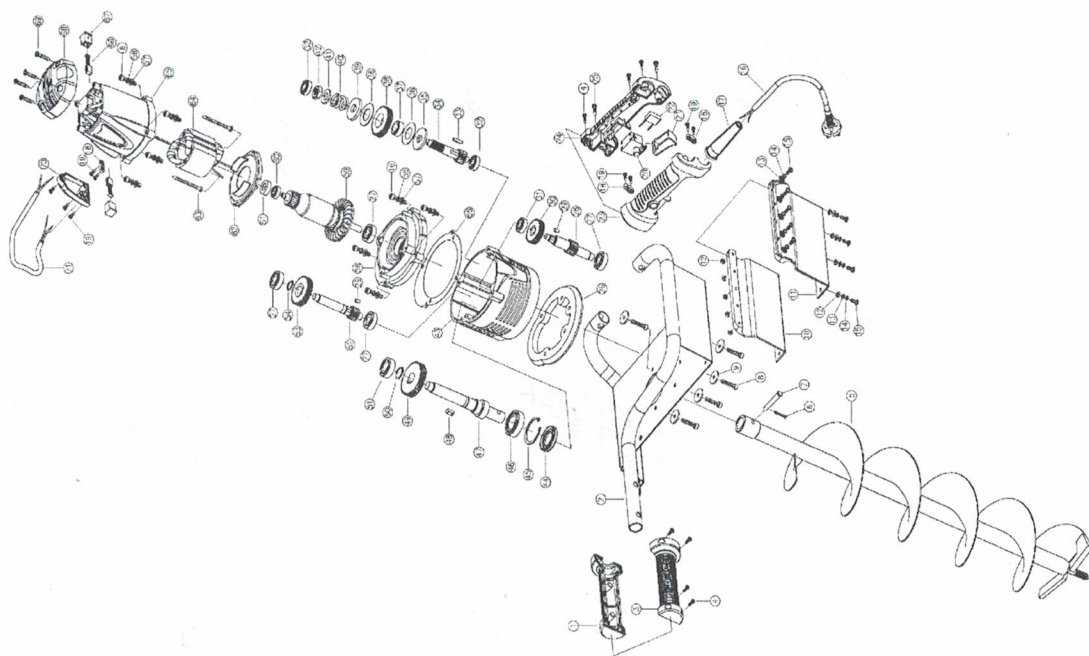

Serial Nr.	Description	Serial Nr.	Description
1	Left Side Handle	37	Gear Sleeve
2	Supporting Rack	38	Gear
3	Right Side Handle	39	Upper Flange
4	Screw	40	Spring
5	Drill Bit	41	Spring Flange
6	Bolt	42	Nut
7	Pin	43	Gear Box
8	Screw	44	Oil-proof Cover
9	Washer	45	Lock Spring
10	Left Safety Board	46	Bearing
11	Right Safety Board	47	Spindle
12	Nut	48	Woodruff Key
13	Washer	49	Gear
14	Spring Washer	50	Lock Spring
15	Screw	51	Bearing
16	Cable	52	Gear Spindle
17	Cable Jacket	53	Gear
18	Strain Relief	54	Lock Spring
19	Screw	55	oil-proof Paper
20	Switch	56	Middle Cover
21	Switch Button	57	Washer
22	Capacitor	58	Spring Washer
23	Left Handle	59	Rotor
24	Right Handle	60	Bearing
25	Screw	61	Bearing Cover
26	Rubber Circle	62	Wind-proof Circle
27	Bearing	63	Screw
28	Gear Spindle	64	Stator
29	Woodruff Key	65	Housing
30	Gear	66	Carbon Brush
31	Bearing	67	Carbon Brush Holder
32	Bearing	68	Rear Cover
33	Woodruff Key	69	Screw
34	Gear Spindle	70	Safety Cover
35	Down Flange	71	Connection Wire
36	Friction Piece		

ENVIRONMENT



Should your appliance need replacement after extended use, do not discard it with the household rubbish but dispose of it in an environmentally safe way. Waste produced by electrical machine items should not be handled like normal household rubbish. Please recycle where recycle facilities exist. Check with your Local Authority or retailer for recycling advice.