

Installation Guide

for Andersen® LuminAire™ Retractable Insect Screen Door with SlideAway® Insect Screen System

Designed for 32" – 36" wide by 80" tall single hinged doors with suitable mounting surface.

For installation help please visit www.AndersenLuminAire.com/install



Please Do Not Return Product to Store!

PLEASE call the Storm Door Solution Center at 844-813-6664,

with any questions regarding installation, lost part replacement, or anything else related to your retractable insect screen purchase. Replacement parts can also be found at: parts.andersenstormdoors.com

Read this entire guide before you begin your installation. If your abilities do not match the requirements of this installation, contact an experienced contractor.

PARTS OVERVIEW

Your installation kit should contain the following parts.

- 1 Screen Housing (one with handle & orange clips)
- 2 Latch Housing (one without handle or clips)
- 3 Screen Tracks (top and bottom)
- 4 End Caps (attached to ends of housings)
- 5 Sill Adapter
- 6 Orange Installation Clips
- 7 Shipping Plastic Wrap

8 Not Shown

Screw Pack containing:

- 1 inch #8 screws (qty 6)
- ½ inch #8 self-tapping screws (qty 3)
- ⅛ inch Drill Bit
- #2 Phillips Bit

NOTE: The orange installation clips attached to the Screen Housing provide product protection during shipping and installation. **DO NOT** extend screen from housing or remove installation clips until instructed.

NOTICE

To avoid product damage, be sure to place all parts of your retractable insect screen on a soft non-abrasive surface such as carpet, drop cloth placed on your lawn or cardboard.

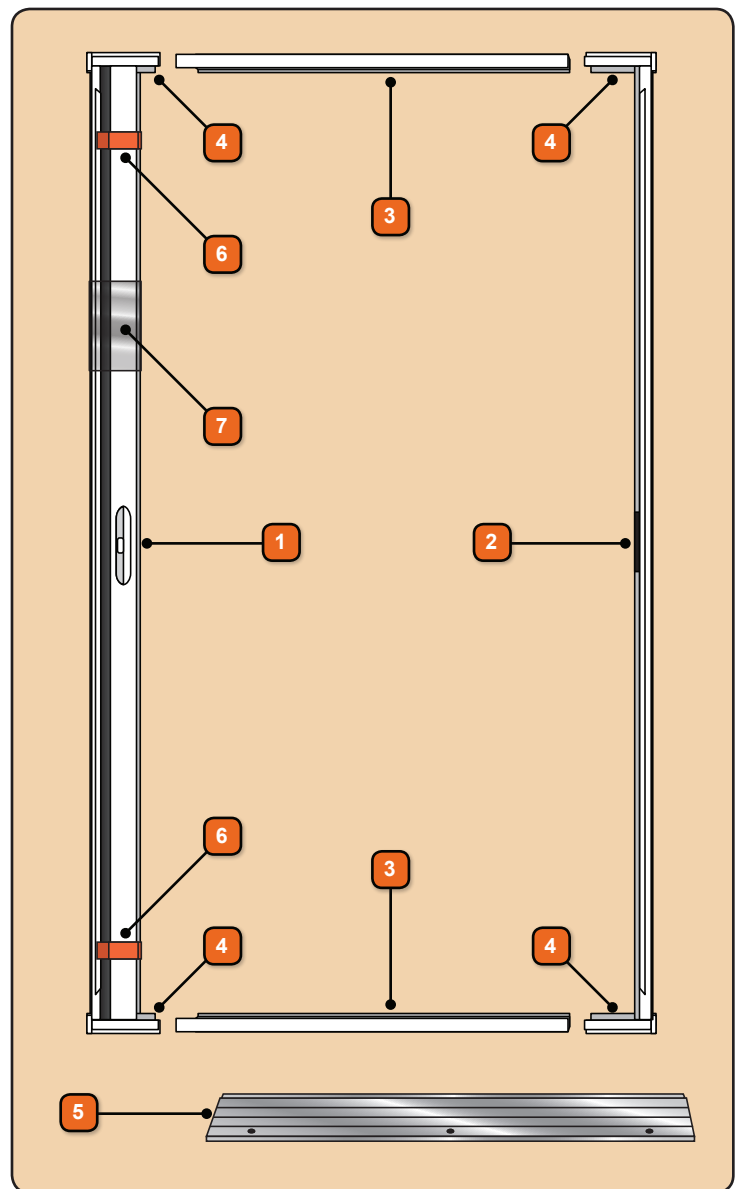

SAFETY FIRST: Please read and follow all Cautions and Warnings in this guide.

WARNING

Follow manufacturers' instructions for hand and power tools. Always wear safety glasses. Failure to do so could result in injury, product or property damage.

WARNING

Windows and doors can be heavy. Use safe lifting techniques and a reasonable number of people with enough strength to lift, carry, and install window and door products. Heavier windows and doors will require mechanical assistance. Failure to do so could result in injury, product or property damage.

CAUTION

Metal components of the retractable insect screen may become hot when exposed to sunlight.

WARNING

Metal fasteners and components could corrode when exposed to preservative-treated or fire-retardant treated lumber. Use approved fasteners and components to fasten window or door. Failure to do so could cause a failure resulting in injury, product or property damage.

IMPORTANT

The retractable insect screen is intended for reasonable insect control and not the retention of objects, persons, or pets within the interior. The retractable insect screen will not stop a person from falling through the door.

Fastener must attach to a structural framing member with a 1" minimum fastener embedment. Failure to do so could result in injury, product or property damage.

DO NOT remove screws that attached installation clips or gusset plates to window or door frames. Doing so could result in injury, product or property damage.

RECOMMENDED TOOLS

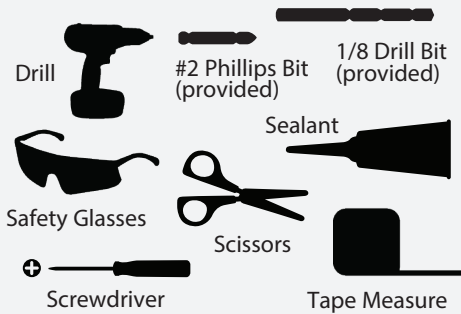

For installs less than 31-7/8" wide



This is the Safety Alert Symbol used to alert you to potential injury hazards. Obey all safety messages that follow this symbol to avoid possible injury or death.

Signal Word and Consequence

COULD Result in:	WARNING Major Injury / Death	COULD Result in:	CAUTION Minor Injury
COULD Result in:	NOTICE Product or Property Damage	IMPORTANT Procedure and Product Information	

MEASURE - VERIFY MOUNTING SURFACE REQUIREMENTS AND MEASURE DOOR OPENING*

Verify that the exterior brickmould, trim board or casing (exterior trim) is firmly attached to the opening structure and is a material that is suitable to sufficiently fasten the retractable insect screen to the door opening. The performance of the retractable insect screen could be effected over time if it is not sufficiently fastened to the opening.

To install the retractable insect screen door, you must verify that the opening width, height and mounting surface are suitable size to properly install into the opening.

1. Measure the width at the top (W1), middle (W2), and bottom (W3) of the opening (see Figure 1). Measure from the inside of the exterior trim. Utilizing the narrowest width, reference chart below.
2. Measure the height at the center of the opening, from the bottom of the exterior trim at the top of opening down to the sill at the bottom of opening. Reference chart for height compliance.

Configuration Widths (Adjustable Width - Use for Step 1b)	Opening Widths (Configuration Ranges)	Opening Heights
36 Configuration	34" - 36 3/8"	80" (80" - 80 7/8")
32 Configuration	31 7/8" - 33 15/16"	Also Available in
See Appendix A (Pg. 6)	Less than 31 7/8"	78" (78"-78 7/8") or 84" (84"- 84 7/8")

3. Make sure that the exterior trim meets the mounting surface requirements to accommodate the retractable insect screen assembly (see Figure 2). The assembly needs 3/4" flat surface on exterior trim face and 3/4" minimum depth of mounting surface.

CAUTION

If the **Door Sill** doesn't extend past the **Mounting Surface** or doesn't have sufficient support, product damage, injury or both may occur.

- If the **Door Sill** extends past your exterior trim **Mounting Surface** and is supported, no modification is required (see Figure 3a).
- If the **Door Sill** is extended without support or not extended (see Figure 3b), you will need to add support blocking. See Appendix B (on page 6).

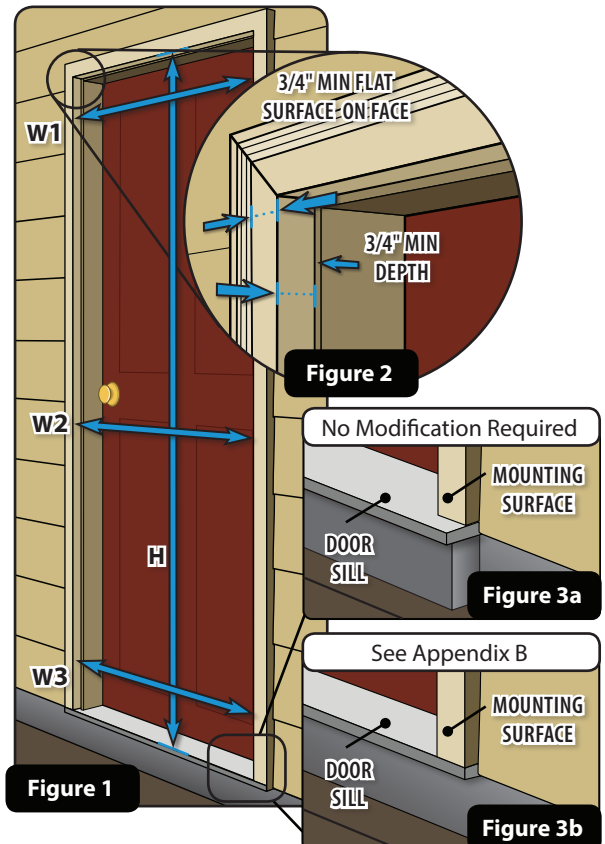

* Andersen retractable insect screens are designed to be installed on the exterior of the home. However, the door can be installed on the interior (i.e. for outswinging door openings) as long as the opening meets the sizing and mounting surface requirements. For changing handle orientation, see page 7.

1

ASSEMBLE SCREEN TRACKS & HOUSINGS

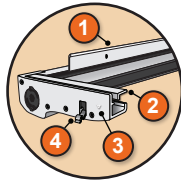

Screen Housing

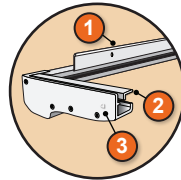

Latch Housing

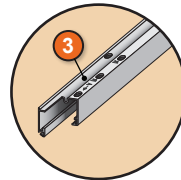

Screen Track (A/B)

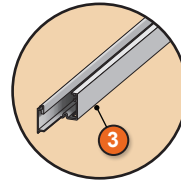

Screen Track (C/D)

KEY REFERENCES

- 1 Screw Flanges
- 2 Receiving Tabs
- 3 Letter Labels
- 4 Fastener Clips

a ALL ITEMS DURING THE ASSEMBLY STEPS SHOULD BE LAYING FLAT ON THE GROUND

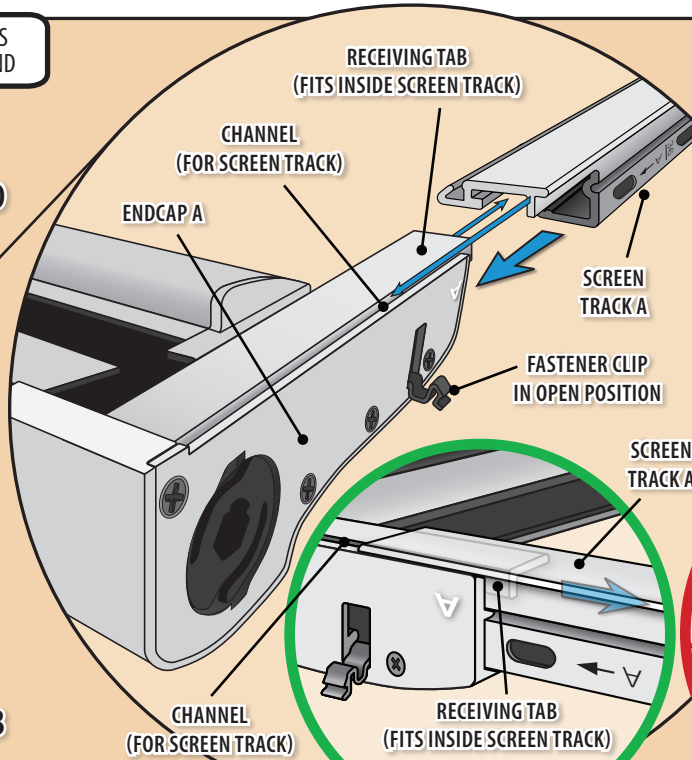
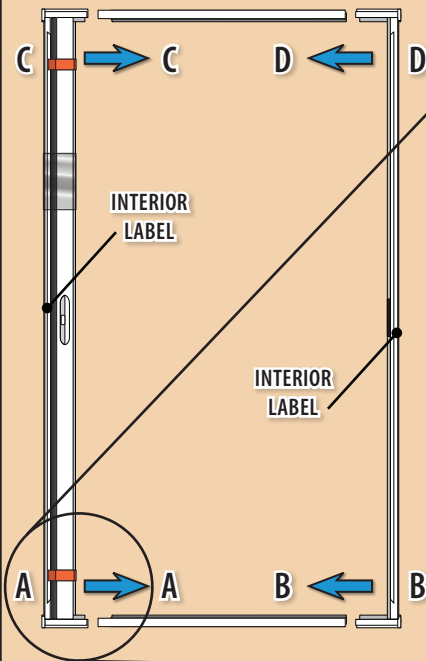

NOTICE

Receiving Tabs on the Endcaps must slide inside the Screen Track. Product damage may occur if Receiving Tab is forced outside the screen track.

Visit AndersenLuminAire.com/install to view a video of this step.

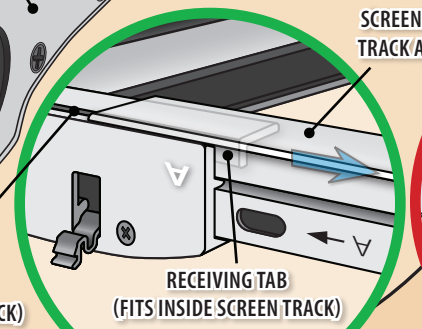

CORRECT

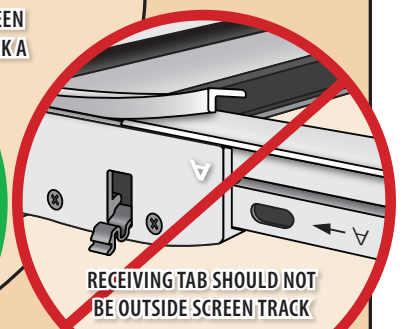

RECEIVING TAB SHOULD NOT BE OUTSIDE SCREEN TRACK

INCORRECT

- a1** Unpack the housings and screen tracks onto a non-abrasive surface, with the side labeled **Interior** facing up. Leaving the screen in the retracted position, arrange the components so the letters marked on the **Screen Tracks** and the letters marked on the **Endcaps** align (A to A, B to B, C to C and D to D).
- a2** Confirm the **Fastener Clips** on endcaps A and C are in the open position. Starting at corner A, slide the **Receiving Tab** on **Endcap A** inside the **Screen Track**. Ensure the **Receiving Tab** fits inside the **Screen Track**, and the **Screen Track** slides into the **Channel**. (see "correct" above).
(Visit AndersenLuminAire.com/Install to view a video of this step.)
- a3** Repeat for corner C, then continue to corners B and D. They do not have Fastener Clips, which allows the door assembly to adjust to your door opening width.
- a4** Use the "36 Configuration" for openings 34" - 36 3/8" wide or "32 Configuration" for openings less than 34" wide in step b.
(If the opening is narrower than 31 7/8" wide, See Appendix A on page 6.)

b 36 Configuration

(use for opening widths between 34" to 36-3/8")

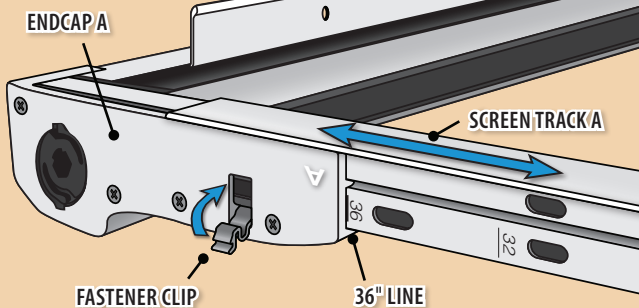

- b1** If the opening is between 34" and 36 3/8", adjust **Screen Track A** until **36" line** aligns with edge of **Endcap A**.
- b2** Rotate the **Fastener Clip** up until it snaps into the closed position.
- b3** Repeat steps for side C.

32 Configuration

(use for opening widths less than 34")

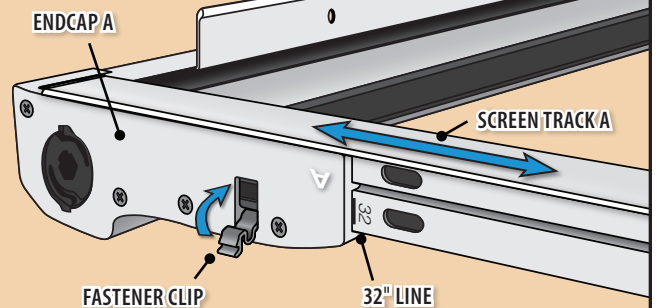

- b1** If the opening is less than 34", adjust **Screen Track A** until **32" line** aligns with edge of **Endcap A**.
- b2** Rotate the **Fastener Clip** up until it snaps into the closed position.
- b3** Repeat steps for side C.

2

PLACE AND FASTEN ASSEMBLY INTO OPENING

Tools Recommended:

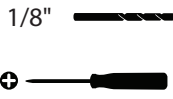

Scissors

SCREW PACK

#8-1"
(Qty 6)

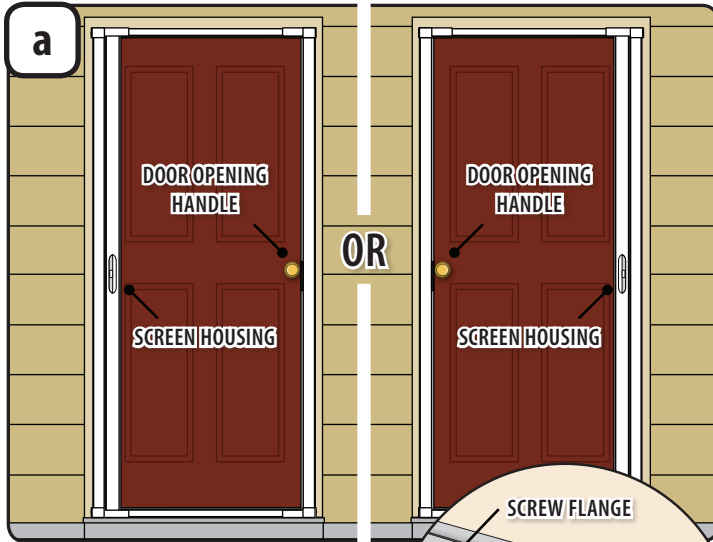
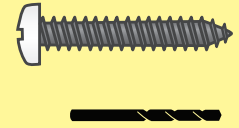

a1 With a Scissors, cut Plastic Wrap along inside edge of Screw Flange.

a2 With the interior of the screen assembly facing the door opening, rotate the assembly so the Screen Housing is on the opposite side of the Door Opening Handle.

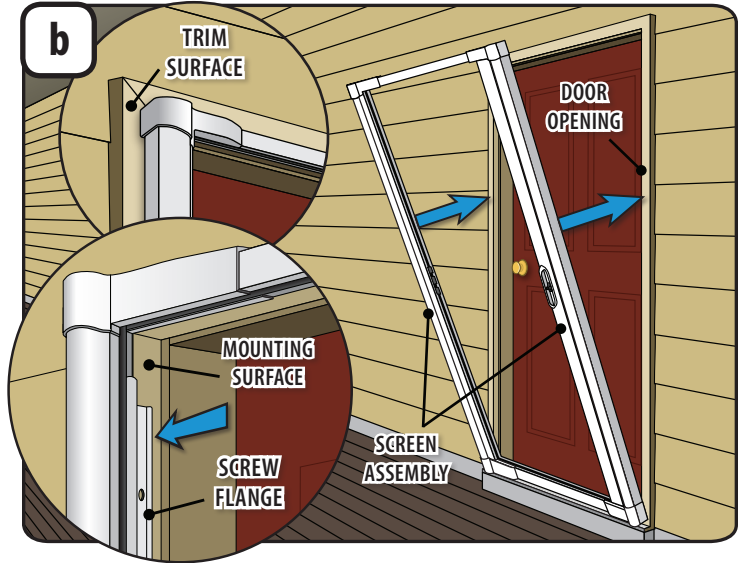
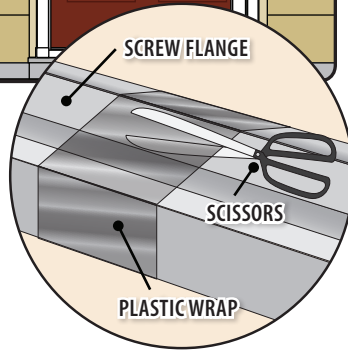

b1 The screen assembly will be narrower than your opening until fully expanded in the following steps.

b2 Start by placing the Screen Assembly onto the exterior Trim Surface, with the Screw Flanges extending into the Door Opening. Rest the bottom of the screen assembly onto your sill or support blocking.

b3 Slide the screen assembly in the door opening until the Latch Housing side Screw Flange is tight to the Mounting Surface.

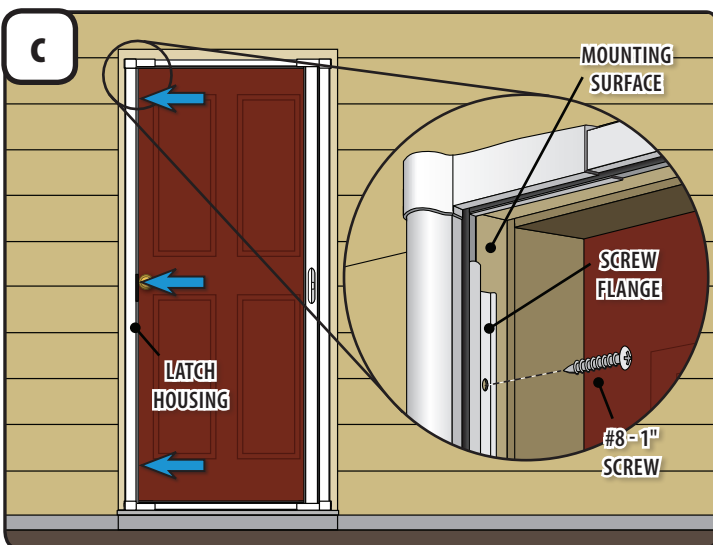

c1 Verify the Latch Housing side Screw Flange is tight to Mounting Surface.

c2 With 1/8" bit provided, predrill through the three holes on the Latch Housing side Screw Flange into the Mounting Surface a maximum depth of 3/4".

c3 With three of the #8 - 1" screws, fasten Latch Housing side of screen assembly to the Mounting Surface. (Be careful not to over tighten)

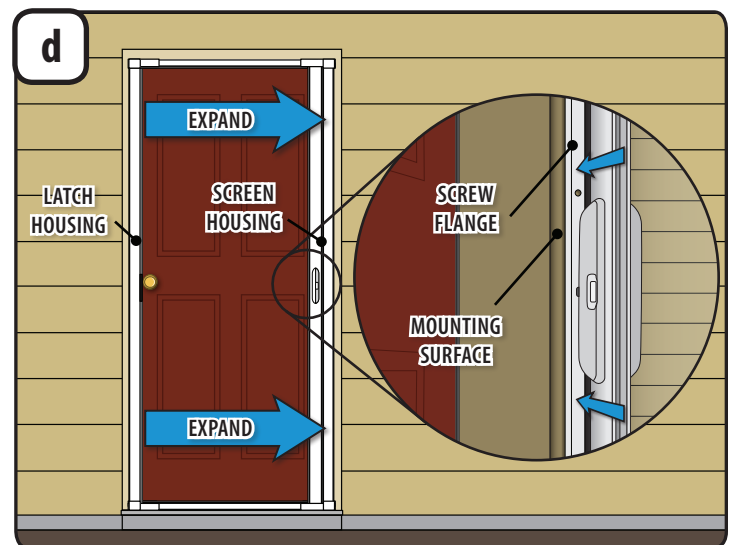

d Expand screen assembly by sliding Screen Housing side until the Screw Flange is tight to the Mounting Surface.

2 PLACE AND FASTEN ASSEMBLY - Continued

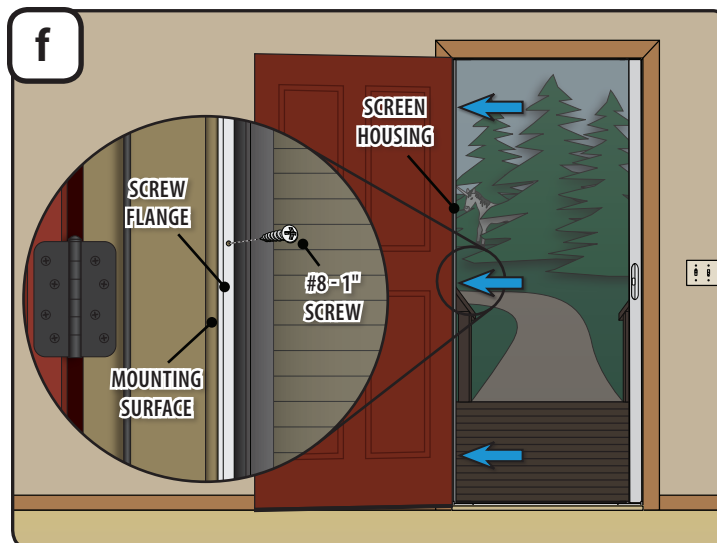
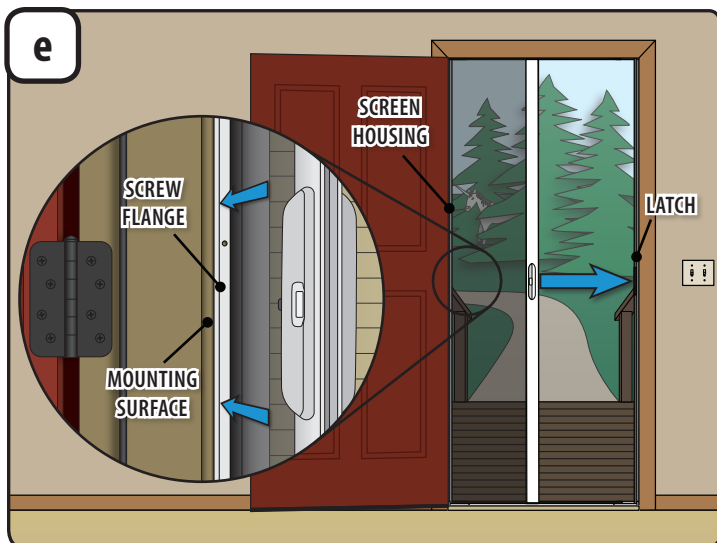

e From the interior of the screen assembly, hold the **Screen Housing** side **Screw Flange** against the **Mounting Surface**, extend the insect screen across the assembly and latch. Orange Installation Clips can come off and be properly disposed of.

- f1** Verify the screen assembly is plum, level and square in the door opening and the **Screen Housing** side **Screw Flange** is tight to **Mounting Surface**.
- f2** With $\frac{1}{8}$ " bit provided, predrill through the three holes on the **Screen Housing** side **Screw Flange** into the **Mounting Surface** a maximum depth of $\frac{3}{4}$ ".
- f3** With the three remaining **#8 - 1"** screws, fasten **Screen Housing** to the **Mounting Surface**. (Be careful not to over tighten)

3 PLACE AND FASTEN SILL ADAPTER

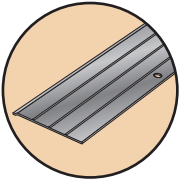



Sill Adapter

Tools Recommended:





$\frac{1}{8}$ " 

#2 Phillips 



SCREW PACK

#8 - $\frac{1}{2}$ "
(Qty 3) 

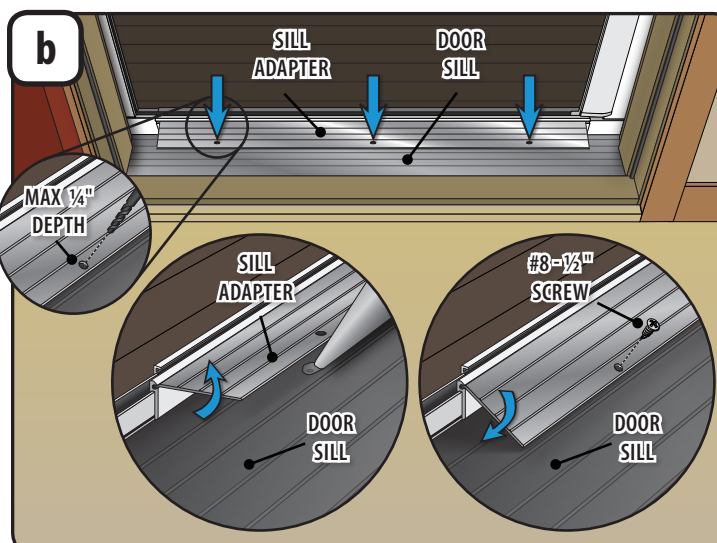
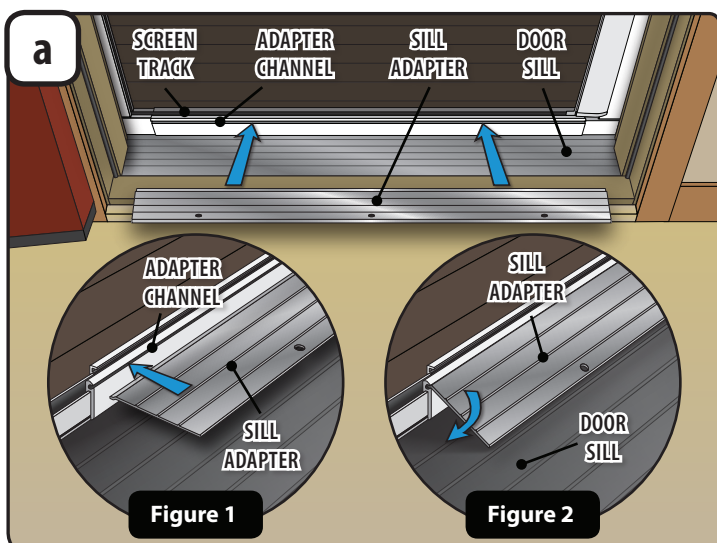

- a1** Thoroughly clean the **Door Sill**.
- a2** From the interior of screen assembly, position **Sill Adapter** with the textured side up and screw holes in toward the interior of the home.
- a3** Insert edge of the **Sill Adapter** into the **Adapter Channel** located on the **Screen Track** (see **Figure 1**).
- a4** Rotate the **Sill Adapter** down to the **Door Sill** (see **Figure 2**).
- a5** Center the **Sill Adapter** in the door opening.*

- b1** With $\frac{1}{8}$ " bit provided, predrill through the three holes on the **Sill Adapter** into the **Door Sill** a maximum depth of $\frac{1}{4}$ ".
- b2** Lift **Sill Adapter** and apply sealant into predrilled holes until sealant over-flows onto **Door Sill** surface.
- b3** Rotate the **Sill Adapter** back down to the **Door Sill** and fasten using three **#8 - $\frac{1}{2}$ " Self-Tapping Screws**. Cleanup excess sealant.

* 30.5" sill adapter is designed to avoid the need for cutting during installation. If a wider sill adapter is preferred, visit parts.andersenstormdoors.com

APPENDIX - STEPS FOR NARROW OPENING AND SUPPORT BLOCKING FOR SILL (if required)

A

APPENDIX A Narrow Opening Modification for Openings less than 31 7/8" wide.

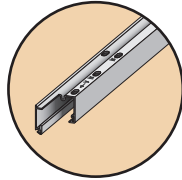

Screen Track (A/B)

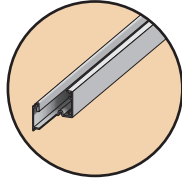

Screen Track (C/D)

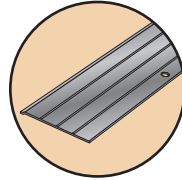

Sill Adapter

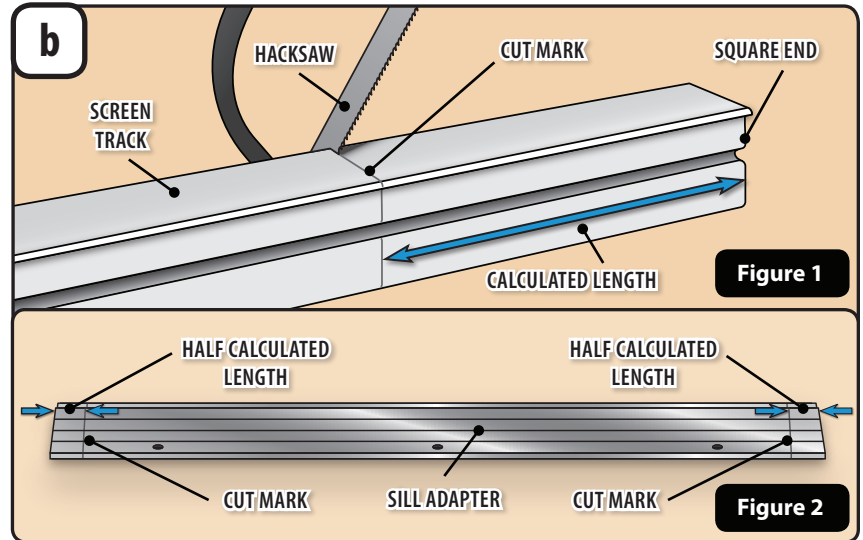
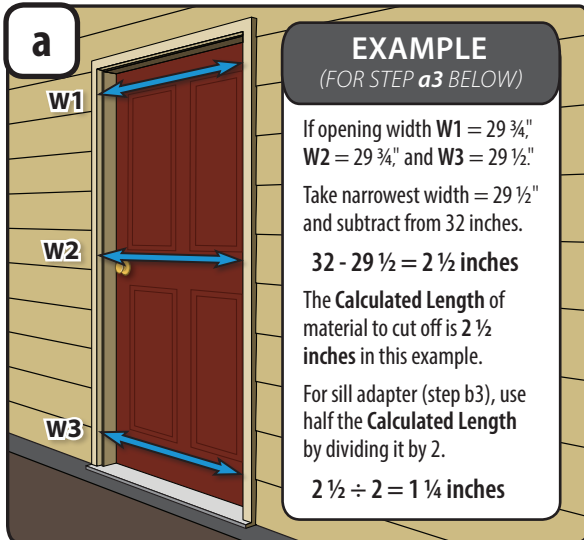
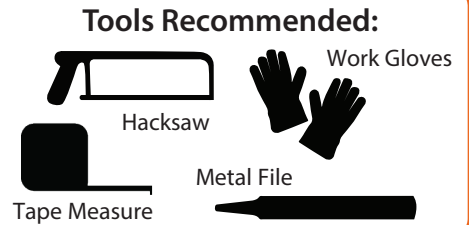

- a1 To modify screen assembly to work in a Narrow Opening, the Screen Tracks and Sill Adapter need to be cut down.
- a2 Measure door opening width at top (W1), middle (W2), and bottom (W3) from the inside of the exterior trim.
- a3 Calculate Length of material to be cut off by taking the narrowest width from above and subtracting it from 32 inches (see Example above).

- b1 Measure and mark from Square End of the Screen Track (side B) the Calculated Length.
- b2 With a Hacksaw make a clean square cut through the Screen Track at the Cut Mark. With a metal file, file down all sharp edges. Repeat steps for the other Screen Track (side D) (see Figure 1).
- b3 Measure and mark from each end of the Sill Adapter the Halved Calculated Length so equal amounts are removed from both sides (see Figure 2).
- b4 With the Hacksaw make a clean square cut through the Sill Adapter on both ends at the Cut Marks. With a metal file, file down all sharp edges. Return to Measure on Page 2.

B APPENDIX B – Support Blocking for Door Sill

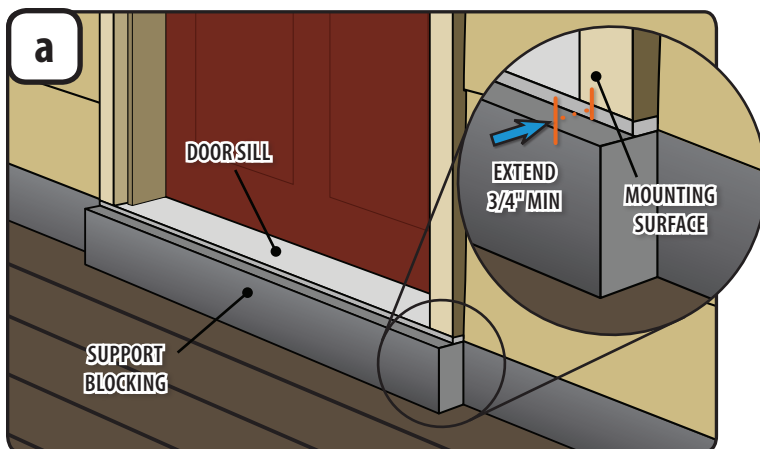

- a1 Choose Support Blocking the width of the Door Sill with enough depth to Extend 3/4" Minimum out from the exterior trim Mounting Surface.
- a2 Center the Support Blocking under the sill and make sure it is level and parallel to the sill. Confirm it Extends 3/4" Minimum from Mounting Surface.
- a3 Properly secure Support Blocking below the Sill.
Return to Measure on Page 2.

C APPENDIX C – Outswing Door Openings

Andersen retractable insect screens are designed to be installed on the exterior of the home. However, the door can be installed on the interior (i.e. for outswing door openings) as long as the opening meets the sizing and mounting surface requirements.

Handle orientation can be reversed by unscrewing the Interior Handle and reassembling in the rotated reversed configuration. Take care to align the Latch Plate with the Handle Spindles when reassembling. For more details, see figure 3 on Page 7.

FREQUENTLY ASKED QUESTIONS – ANDERSEN® LUMINAIRE™ RETRACTABLE INSECT SCREEN

1. How do I open and close the insect screen?

Use the **Handle** to extend insect screen to the other side of door frame. It will automatically latch when fully extended. Slide the **Release Lever** up or down to unlatch, the insect screen will automatically retract (see Figure 1).

2. How do I lock and unlock the insect screen?

To lock the insect screen door, move the **Lock Tab** toward the screen assembly. To unlock, move the **Lock Tab** away from the screen assembly (see Figure 2).

3. What should I do to maintain my retractable insect screen door?

The screen tracks will need occasional vacuuming to remove dirt and debris. This will help keep the tracks clean and free of debris that may affect operation.

4. Can the handle be reversed so the locking tab is on the other side of the door?

The handle can be removed and reversed by unscrewing the **Interior Handle** and reassembling in the rotated reversed configuration. Take care to align the **Latch Plate** with the **Handle Spindles** when reassembling (see Figure 3).

5. Can the fastener clips be opened if I closed them in the wrong position during installation?

You can open the fastener clip by applying downward pressure with a flat blade screwdriver until it releases open (see Figure 4).

6. Can replacement parts be purchased if something gets damaged on my door?

Parts can be purchased by visiting parts.andersenstormdoors.com or calling Customer Service at 844-813-6664. It is helpful to have your serial number when ordering parts. The serial number is located near Endcap A on your screen housing.

7. The door is not latching consistently, is there an adjustment that can be made?

The **Striker** can be adjusted to assist with more consistent latching of the unit. Loosen the **Striker Screws** and slide the **Striker** up or down accordingly, retighten screws (see Figure 5).

8. What should I do with the unit in cold weather?

It is best for the unit to be stored in the retracted position during cold weather. We do not recommend operating when temperatures are near or below freezing.

9. Why is the sill adapter narrower than the door opening?

The sill adapter provided is designed to avoid the need for cutting for most door opening widths. A wider sill adapter can be ordered at parts.andersenstormdoors.com or by calling Customer Service at 844-813-6664.

10. Is there a video available that will show me how to install and operate the door?

You can find a video of how to install and operate the retractable insect screen door at AndersenLuminAire.com/install

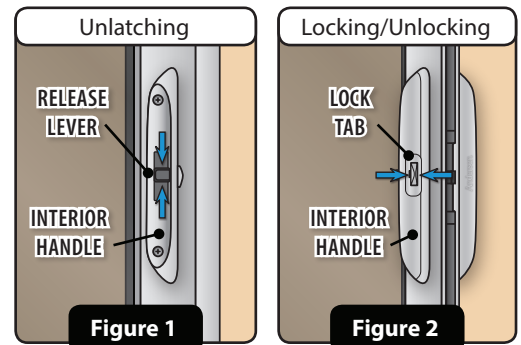

Figure 1

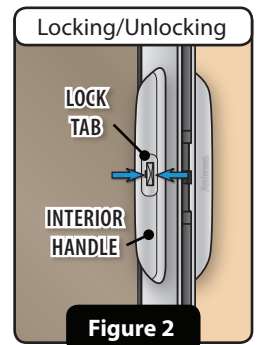

Figure 2

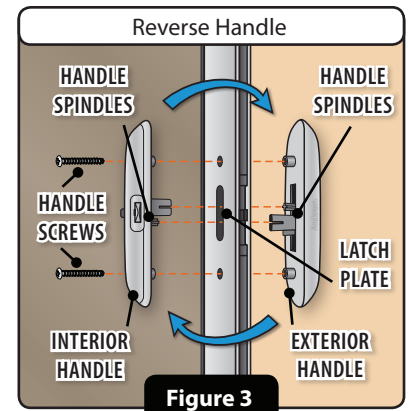

Figure 3

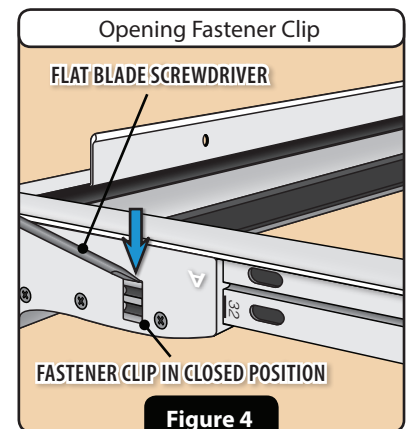

Figure 4

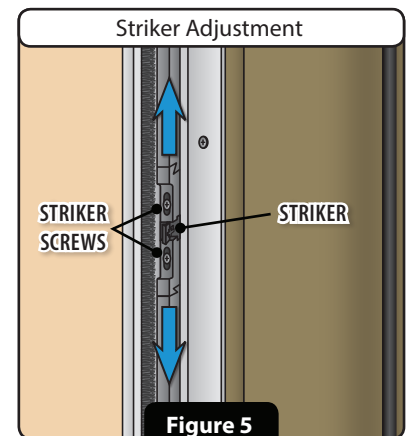

Figure 5

For additional assistance visit ANDERSENLUMINAIRE.COM or Customer Service: 844-813-6664

LIMITED WARRANTY

ANDERSEN® LUMINAIRE™ RETRACTABLE SCREEN DOOR 5 YEAR LIMITED WARRANTY

LIMITED WARRANTY ON RETRACTABLE SCREEN DOOR COMPONENTS

Emco Enterprises LLC (Emco), an Andersen company, warrants the screen housing, latch housing, screen track, endcap and sill adapter components of the Andersen® LuminAire™ retractable screen door to be free from defects in manufacturing, materials, paint adhesion, and workmanship, under normal conditions, for five (5) years from the date of purchase or as long as the original consumer purchaser owns the home in which the door was initially installed, whichever is shorter.

In the event a screen housing, latch housing, screen track, endcap or sill adapter fails as a result of a defect in manufacturing, materials or workmanship within the limited warranty period specified above, and upon written proof of purchase, Emco, will at its option refund or provide a replacement screen housing, latch housing, screen track, end cap or sill adapter without charge – installation is not included. Such replacement is warranted for the remainder of the original limited warranty period. Please locate the door serial number and written proof of purchase then contact Emco Consumer Support at 1-844-813-6664.

NO OTHER WARRANTIES OR REPRESENTATIONS

THIS LIMITED WARRANTY IS IN LIEU OF ALL OTHER WARRANTIES, EXPRESS OR IMPLIED, INCLUDING, BUT NOT LIMITED TO, ANY IMPLIED WARRANTIES OF MERCHANTABILITY OR FITNESS FOR A PARTICULAR PURPOSE. ALL WARRANTIES ARE LIMITED TO THE APPLICABLE STATUTE OF LIMITATIONS, BUT IN NO CASE WILL EXTEND BEYOND THE LIMITED WARRANTY PERIODS SPECIFIED ABOVE. EMCO EXCLUDES AND WILL NOT BE LIABLE FOR ANY INCIDENTAL OR CONSEQUENTIAL DAMAGES, WHETHER ARISING OUT OF CONTRACT, TORT OR OTHERWISE. THE REMEDY OF REPLACEMENT OF THE PRODUCT PROVIDED BY THIS LIMITED WARRANTY IS THE EXCLUSIVE REMEDY WITH RESPECT TO AND ANY AND ALL LOSS OR DAMAGE.

APPLICABLE LAW

This Limited Warranty is only applicable in the U.S.A. (i.e. the fifty states and the District of Columbia). This Limited Warranty gives you specific legal rights, and you may have other rights which vary from state to state or province. Some states do not allow the exclusion or limitation of incidental or consequential damages or limitation of the duration of an implied warranty, so the above limitations or exclusions may not apply to you. If any specific term of this Limited Warranty is prohibited by any applicable law, it shall be null and void, but the remainder of this Limited Warranty shall remain in full force and effect.

WHAT IS NOT COVERED BY THIS LIMITED WARRANTY

Damage caused by:

- **Improper installation (including failure to follow installation instructions), modification, maintenance, or use**
- **Chemicals or airborne pollutants, such as salt or acid rain**
- **Acts of God, including wind damage**
- **Accidents**
- **Normal wear and tear**
- **Products not manufactured by Emco**

Emco Enterprises LLC is a wholly owned subsidiary of Andersen Corporation. Emco manufactures and supports the limited warranties covering Andersen® and EMCO® Storm and Screen Doors. "Andersen" "EMCO" and all other marks where denoted are trademarks of Andersen Corporation. ©2017 Andersen Corporation. All rights reserved.

Reprinted and effective as of September 12, 2017.