

PART NO. D3606A

SPECIFICATION SHEET

Brass 1/2 in. IPS Shower Arm
and flange

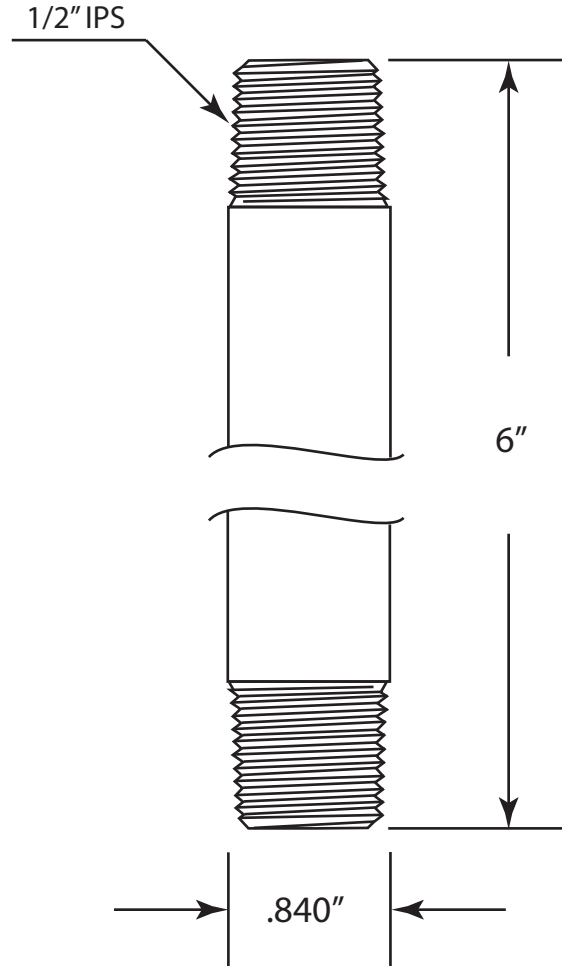
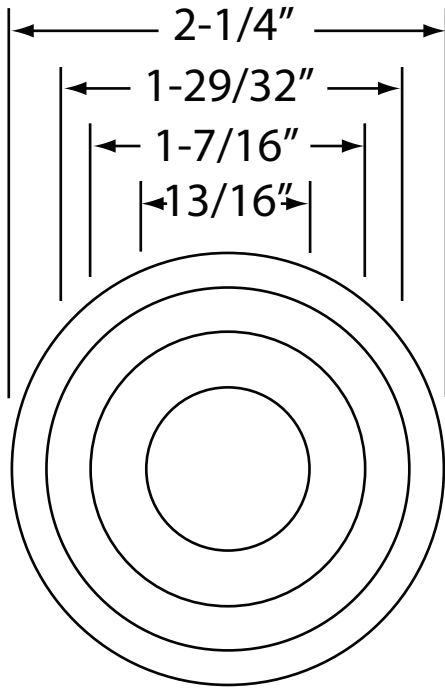

0.109" Wall
Thickness

