

Installation Instructions

For Medium (15,000-18,500 BTU) + Heavy duty (22,000-28,500 BTU) Air Conditioner
READ BEFORE INSTALLING UNIT

INSTALLATION WARNINGS AND CAUTION

- * Carefully read the installation manual before beginning.
 - * Follow each step as shown.
 - * Observe all local, state, and national electrical codes and by qualified, licensed, authorized personnel only.
 - * Pay attention to danger and safety notices.
- To avoid risk of personal injury, property damage, or product damage due to the weight of this device and sharp edges that may be exposed:
- * Air conditioners covered in this manual pose an excessive weight hazard. Two or more people are needed to move and install the unit. Wear protective gloves whenever lifting or carrying the unit. AVOID the sharp metal fins of front and rear coils. To prevent injury or strain, use proper lifting and carrying techniques when moving unit.
 - * Carefully inspect location where air conditioner will be installed. Be sure it will support the weight of the unit over an extended period of time.
 - * Handle air conditioner with care.
 - * Make sure air conditioner does not fall during installation.
 - * If a new electrical outlet is required, have the outlet installed by a qualified electrician before installing unit.

NOTE: DO NOT USE ANY SCREWS OTHER THAN THOSE SPECIFIED HERE.

Preliminary instructions:

Do the following before starting to install unit. See illustrations below.

Check dimensions of your unit to determine model type:

| | Heavy duty | Medium |
|----------------------|-------------------|-------------------|
| Capacity: | 22,000~28,500 BTU | 15,000~18,500 BTU |
| Unit Height: | 18-5/8" | 17-5/8" |
| Unit Width: | 26-1/2" | 23-5/8" |
| Min. Window Opening: | 19-1/2" | 18-1/2" |
| Min. Window Width: | 31" | 28" |
| Max. Window Width: | 42" | 40-1/2" |

1. Check window opening size: the mounting parts furnished with this air conditioner are made to install in a wooden sill double-hung window. The standard parts are for window dimensions listed above. Open sash to a minimum of 19" (483mm). (FIG.1A)

Side louvers and the rear of the air conditioner must have clear air space to allow enough airflow through the condenser, for heat removal. The rear of the unit must be outdoors, not inside a building or garage. There should be at least 11.8 inches (300mm) clearance around the unit. See FIG. 1B & FIG. 1C.

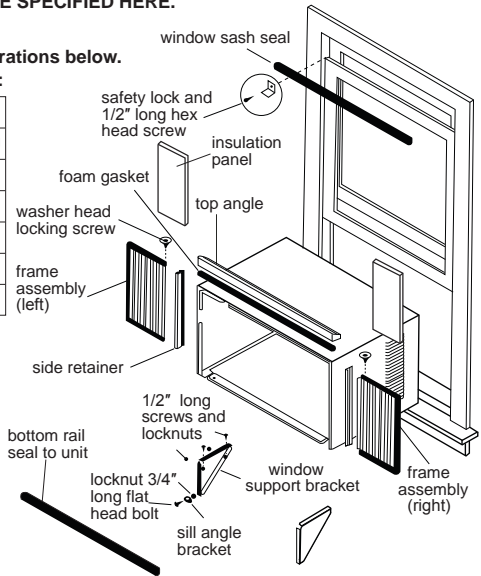
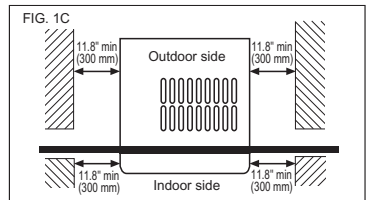
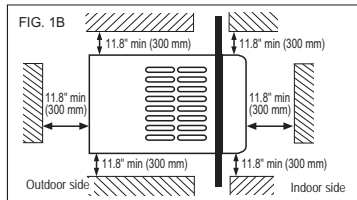
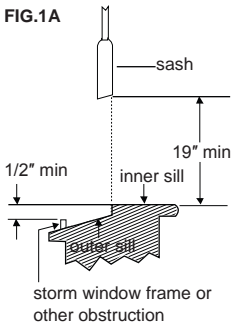

FIG.1A



Installation Instructions

2. Check condition of window: all wood parts of window must be in good shape and able to firmly hold the needed screws. If not, make repairs before installing unit.

3. Check your storm windows: If your storm window frame does not allow the clearance required, correct by adding a piece of wood as shown (FIG.2), or by removing storm window while room air conditioner is being installed.

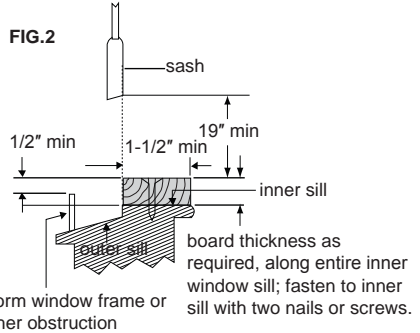

4. Check for anything that could block airflow

Check area outside of window for things such as shrubs, trees, or awnings. Inside, be sure furniture, drapes, or blinds will not stop proper air flow.

5. Check the available electrical service

Power supply must be the same as that shown on the unit serial nameplate. (See Use & Care Guide for serial plate location.) Power cord is 48" long. Be sure you have an outlet near.

All models have a 3-prong service plug to provide proper service and safe positive grounding. Do not change plug in any way. Do not use an adapter plug. If your present wall outlet does not match your plug, call a qualified electrician to make the needed change.

6. Carefully unpack air conditioner

Remove all packing material. Protect floor or other stable flat surface with covering to prevent scratches from unit. With the aid of an assistant, remove unit from styrofoam base and rest on protected surface. Move and install unit with the aid of an assistant. Save packing and shipping box for future unit storage.

WARNING Avoid fire hazard or electric shock. Do not use an extension cord or an adaptor plug. Do not remove any prong from the power cord.

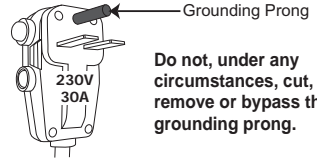
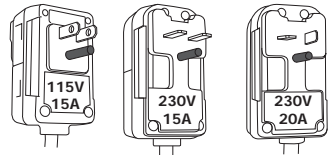





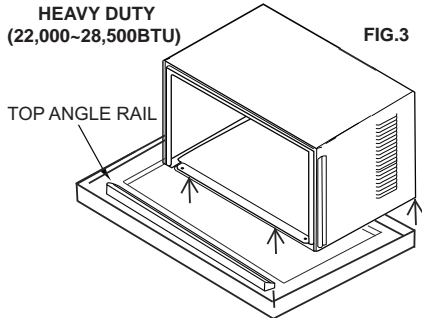





| Accessory Kit includes | |
|--|------------------------|
| • Hardware bag (shipped inside window support brackets) | • Foam gasket |
| • Window support bracket (2) | • Window sash seal |
| • Side retainer (2) | • Insulation panel (2) |
| • Window Filler Panel (2) | • Ruler |
| | • Bottom rail seal |
| | * Top angle rail |
| * MEDIUM models only HEAVY DUTY top angle rail can be found in carton base packaging (FIG.3) | |

| Tools Required | |
|----------------------------------|-------------------|
| • a large flat blade screwdriver | • tape measure |
| • adjustable wrench or pliers | • pencil |
| • level | • Socket wrenches |
| • Phillips screwdriver | |



Installation Instructions

| Hardware (in plastic bag) | Qty. | Hardware (in plastic bag) | Qty. |
|---|------|--|------|
|  7/16" Locking Screw and Flat Washer for window filler panels | 2 ea |  Sill Angle Bracket | 2 |
|  1/2" Long hex head screw | 7 |  Long hex-head locking screw for top angle rail, side retainer 5/16" long | 10 |
|  Safety Lock | 1 |  Safety Lock (for Vinyl-Clad window) | 2 |
|  1/2" Long Screw and locknut | 4 ea |  Locking screw #10 X 1/4" panhead Phillips screws (for Vinyl-Clad window) | 2 |
|  3/4" Long Flat Head Bolt and Locknut | 2 ea |  weather stripping (10"X3/4"X1/12") | 5 |
|  foam insert | 2 | | |

Window Mounting

1 Remove Air Conditioner from Cabinet

NOTE: Remove any packaging material from cabinet exterior.

1. Pull down on front grille from upper edge. Lift front grille upwards and place to one side. (See FIG.1)
2. Remove filter. To remove, grasp in the middle on each side. Bow filter out to detach top edge from tabs. Once top is free, lift filter up and out.

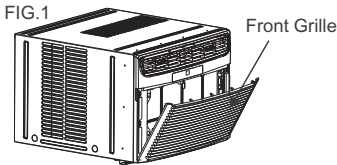
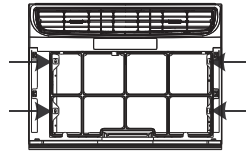
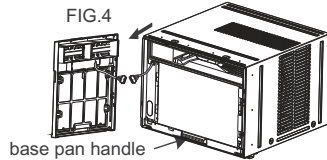
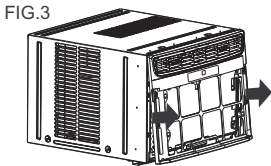

FIG.2



3. Locate the four Front Panel screws and remove. These screws will be needed to re-install the Front Panel later (See FIG.2).
4. Push metal cabinet side inward to release plastic tabs on each side of Front Panel (see Fig. 3).
5. Rotate Front Panel up until top tabs are free. Pull panel straight out. When pulling out, front panel will also pull free from vent control lever. Depress latch on electronics plug (on some models) to disconnect.
6. Remove Front Panel from unit (see Fig. 4).



Installation Instructions

- Remove shipping screws from top of unit and also on both sides by the base if installed. (See FIG.5)
- With the aid of an assistant, hold the cabinet while pulling on the base pan handle (see FIG. 4), and carefully remove the air conditioner from cabinet.
- Add two foam inserts to holes in top of cabinet where shipping screws were removed from. (See FIG.6)
- Except 22,000BTU model, other heavy duty models (24,000~28,500BTU) come with internal shipping packaging. THIS PACKAGING AND PLASTIC TIES MUST BE REMOVED PRIOR TO INSTALLING THE AIR CONDITIONER BACK INTO THE CABINET. (See FIG.7)
- Remove plastic wrapping from all points on power cord.

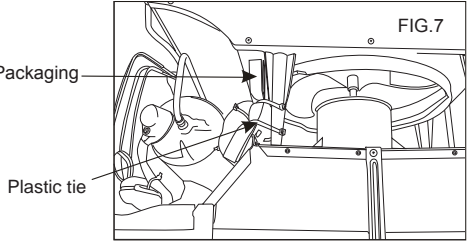
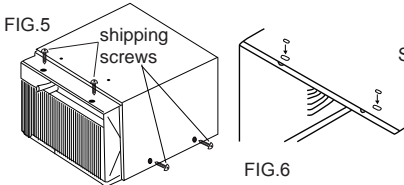

2 Install Top Angle Rail and Side Retainers

- Remove adhesive strip coating from foam gasket. Attach adhesive side of gasket to bottom of top angle rail. Insert 4 screws from inside of cabinet and secure to top angle rail.
- From inside of cabinet insert 3 screws to attach each side retainer as shown in Fig. 8. Attach side retainers with flat side against cabinet and angled edge toward rear of cabinet.

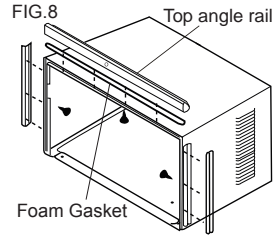

3 Assemble Window Filler Panels

- Place cabinet on floor, a bench, or a table.
- Slide "I" section at end of window filler panel into side retainer on each side of the cabinet (see FIG. 9 and FIG.10).
- On each side of cabinet, insert top and bottom legs of window filler panel frame into channel in the top and bottom angle rails.
- Insert a 7/16" locking screw and flat washer into hole on top leg of each window filler panel (see section 6). Do not totally tighten. Allow leg to slide freely. Screws will be tightened after Section 6.

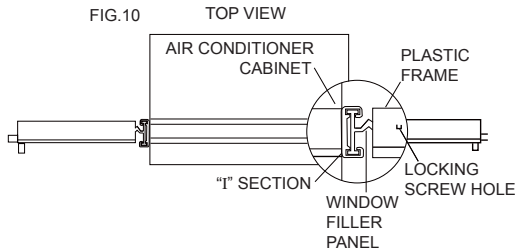
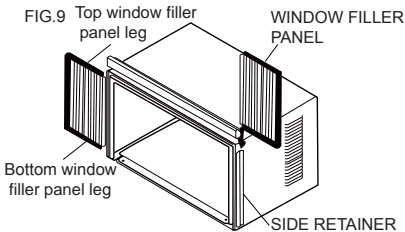

Installation Instructions

4 Place Cabinet in Window

1. Open window and mark the center of window inner sill as shown (FIG. 11).
2. Place cabinet in window with cabinet bracket securely seated over edge of inner sill as shown in FIG. 12. Bring window down temporarily behind top angle rail to hold cabinet in place.
3. Shift cabinet left or right as needed to line up center of cabinet on center line marked on inner sill.
4. **For wooden window:** Fasten cabinet to window inner sill with two 1/2" long hex head screws into holes (FIG. 13A). (You may wish to pre-drill pilot holes.)
For Vinyl-Clad window: Place two safety locks into the holes located in the bottom of the cabinet and drive two #10X1/4" pan-head Phillips locking screws through the safety locks into the cabinet as shown (FIG. 13B).
5. Remove protective strip from adhesive side of Bottom Rail Foam Seal. Apply Seal over screws fastening bottom rail to window inner sill.

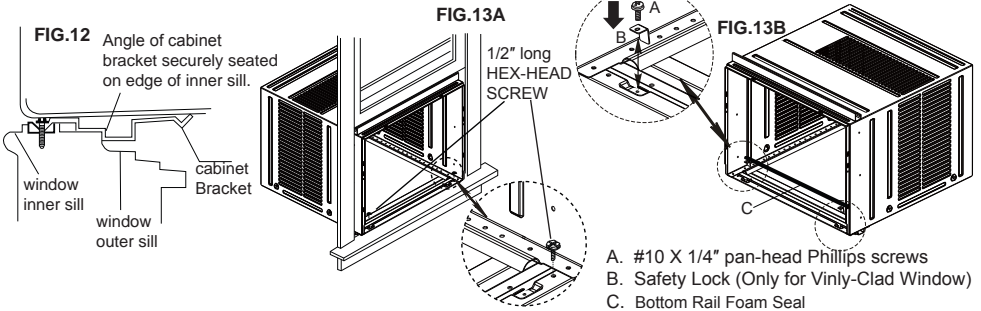
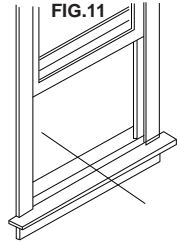

- A. #10 X 1/4" pan-head Phillips screws
- B. Safety Lock (Only for Vinyl-Clad Window)
- C. Bottom Rail Foam Seal

5 Install Support Bracket

1. Hold each support bracket flush against outside of sill and tight to bottom of cabinet. Mark brackets at top level of sill. Mark cabinet bottom at distance of sill width. See Fig. 15 A. Remove support brackets.
2. Attach sill angle brackets to support brackets at marked positions with flat head bolts and nuts. Hand tighten only at this point. See Fig. 15B.
3. Insert 1/2" long bolts through appropriate holes in cabinet bottom given the sill width distance. Thread the bolts into the slots of the support brackets. Tighten lock washer nuts onto bolts.
4. Adjust height of sill angle bracket so that bracket rests securely on edge of sill, and so that cabinet has about 7/8" to 1 1/4" downward tilt for proper water drainage (tilted about 2° to 4° downward to the outside, see Fig. 14). Tighten nuts securely. After proper installation, condensate should not drain from the overflow drain hole during normal use, correct the slope otherwise.

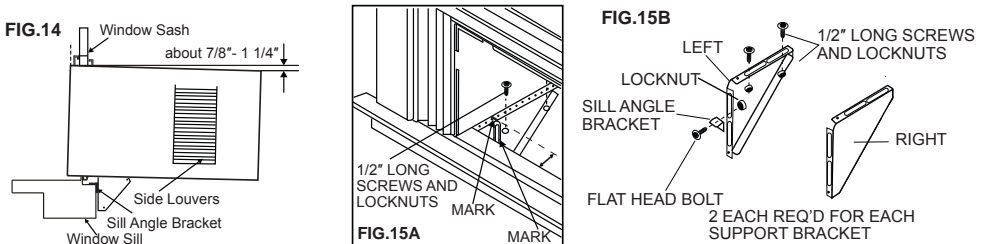

Installation Instructions

6 Extend Window Filler Panels and attach to top angle rail:

1. Carefully raise window to expose filler panel locking screws on top angle rail. Loosen screws so filler panels slide easily.
2. Extend panels to fill window opening completely. Tighten locking screws on top (FIG. 16).
3. Close window behind top angle rail.
4. Attach the top angle rail to window frame: Use a 3/32" drill bit to drill one hole through the hole in the middle of top angle rail into the window frame, and drive one 1/2" HEX-HEAD locking screw through the hole in the middle of top angle rail into the window frame as shown (FIG. 17).

FIG.16

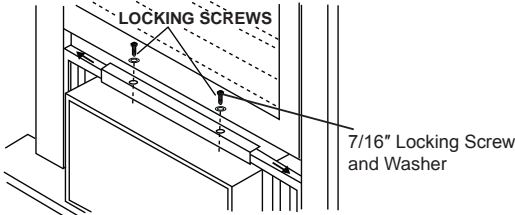
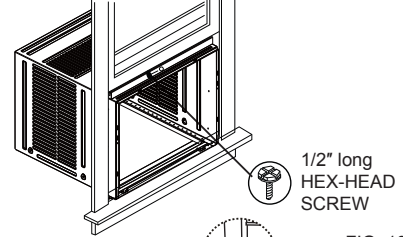
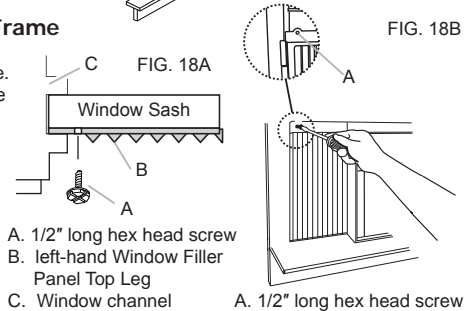

FIG. 17



7 Attach Window Filler Panels to Window Frame

1. Extend the window filler panels out against the window frame.
2. Use a 1/8" drill bit to drill a starter hole through the hole in the top leg of each window filler panel and into the window sash (Fig. 18A and Fig. 18B). Connect with one 1/2" long hex head screw.



8 Install Window Sash Seal and Safety Lock

1. Trim window sash seal to fit window width. Insert it into space between upper and lower sashes as shown (FIG. 19).
2. Attach right angle safety lock to top window sash as shown (FIG.20).
3. If necessary, trim weather seals to needed length, peel off protective backing, and use to plug any gaps. See Fig. 18B.

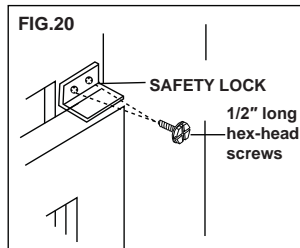
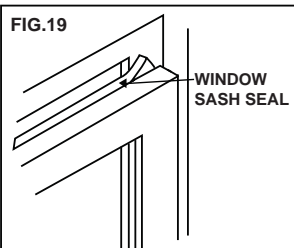
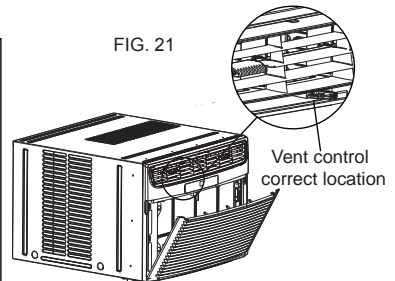

FIG. 21



9 Install Air Conditioner into Cabinet and Install Front Panel to Unit

1. Lift air conditioner and carefully slide into cabinet.
2. **CAUTION: Do not push on controls OR finned coils.**
3. Be sure air conditioner is firmly seated towards rear of cabinet.
4. Reconnect electronics plug if present. Position vent control lever so that it will thread into its channel in the front panel (see FIG.21). Hook front panel top tabs into slots on cabinet top, and rotate front panel down so that side tabs snap into place on cabinet. Insert 4 previously removed screws through front panel and into air conditioner.
5. Insert air conditioner filter. Reinstall the front grille by hooking bottom tabs into slots on Front Panel bottom, then rotating grille up to snap into place.

Installation Instructions

10 Install Insulation Panel

1. Measure the width of the inner side curtain with the provided ruler (FIG. 22).
2. Mark a line on the patterned side of the provided insulation panel according to the measured width in Step 1, then cut out the insulation panel along the line (FIG. 23).
3. Place the patterned side of the insulation panel to face inside your room, then slide the insulation panel into the frame until the panel goes into the side curtain frame completely. If the insulation panel does not slide in the frame smoothly, trim the insulation panel then try again, until the insulation panel fits the frame (FIG. 24).
4. Repeat these instructions for the other side.

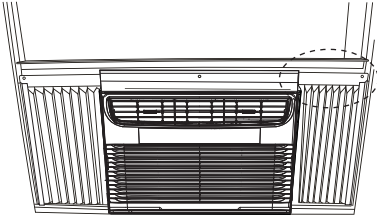
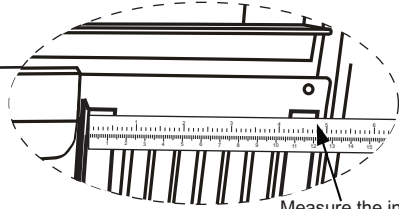

FIG. 22



Measure the inner width of the side curtain

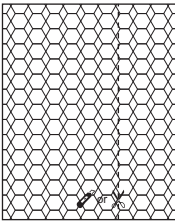

FIG. 23

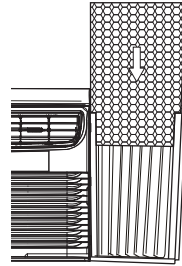

FIG. 24

- 11 In order to minimize air leaks between the room air conditioner and the window opening, suitable weather stripping(trim the provided weather stripping into suitable size) should be applied in case of any gaps found at the location as indicated by the arrows in Fig. 25.

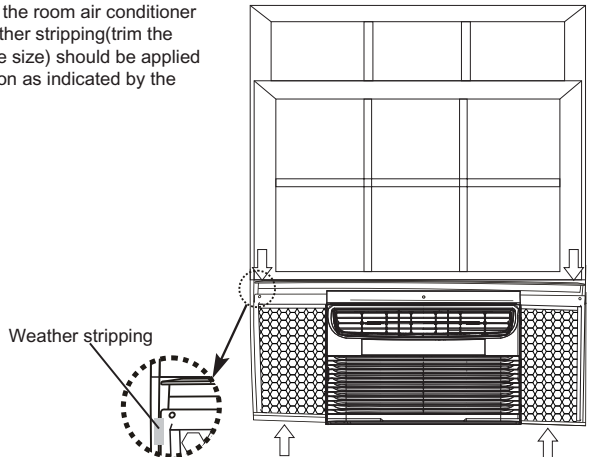

FIG. 25

Installation Instructions

Thru-The-Wall Installation

NOTE:

- Consult local building codes prior to installation, or a qualified carpenter.

1 Select Wall Location

This air conditioner slides out from its cabinet, so that it can be installed through an outside wall as explained below.

| | Heavy duty | Medium |
|--------------------|------------|--------|
| Max wall thickness | 10" | 8" |

NOTE:

- **IMPORTANT: Side louvers must never be blocked.**
- All parts needed for Thru-The-Wall Installation are provided, except a wood frame, shims, and 10 wood screws (#10-1" long minimum). Select a wall surface that:
 1. Does not support major structural loads such as the frame construction at ends of windows, and under truss-bearing points, etc.
 2. Does not have plumbing or wiring inside.
 3. Is near existing electrical outlets, or where another outlet can be installed.
 4. Faces to the area to be cooled, and it is not blocked.
 5. Allows unblocked airflow from rear sides and end (outside) of installed air conditioner.

2 Prepare Wall

1. Prepare wall in frame construction (including brick and stucco veneer). Working from inside the room, find wall stud nearest the center of area where air conditioner will be installed (by sounding wall, or by magnetically finding nails).
2. Cut out a hole on each side of center stud.
3. Measure between inside edges of every other stud as shown in FIG.1. Carefully measure and cut an opening with the following dimensions depending on your model. See FIG.1 and FIG.2.

WIDTH "X" = inside model width plus twice the thickness of framing material used.

HEIGHT "Y" = inside model height plus twice the thickness of framing material used.

| | Heavy Duty | Medium |
|----------------------|-------------------|-------------------|
| Capacity: | 22,000~28,500BTU | 15,000~18,500BTU |
| Inside Frame Height: | 18-7/8" (47.9 cm) | 18" (45.7 cm) |
| Inside Frame Width: | 26-3/4" (67.9 cm) | 23-7/8" (60.6 cm) |

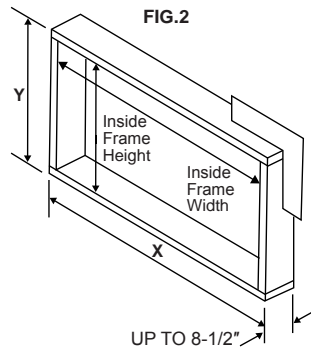
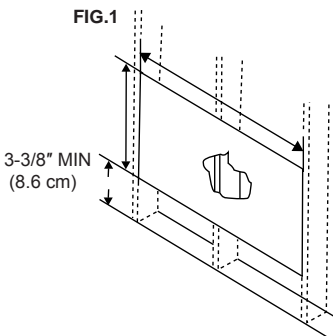

Installation Instructions

4. Build a wooden frame with the INSIDE dimensions of your model listed above. (Measure twice remember...) Frame depth should be the same as wall thickness. Fill in the space from the opening to the studs with wood spacers, as shown.
5. Nail frame to spacers to spacers with front flush with dry wall.

NOTE:

- If wall thickness is 8-1/2" or more, add aluminum flashing over bottom of frame opening to assure no water can enter area between inner and outer wall.

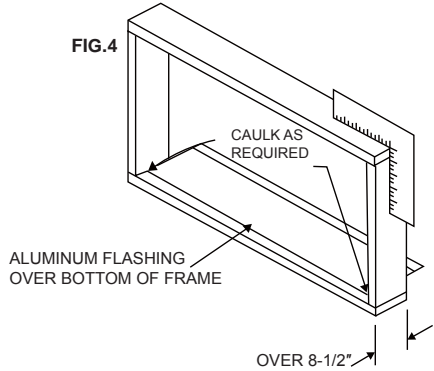
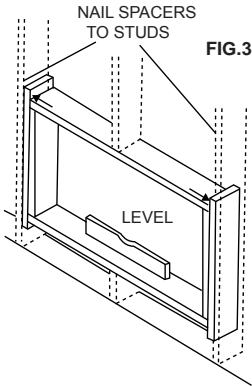

3 Prepare and Install Cabinet

1. Slide air conditioner from cabinet; refer back to Step 1 of Window Mounting.
2. Place cabinet into opening with bottom rail resting firmly on bottom board of wooden frame.
3. Position cabinet to achieve proper downward tilt for water removal. Unit must tilt back about 7/8" to 1 1/4" for proper water drainage. (See FIG.5 below.)
4. Secure bottom rail to wood frame with two large wood screws 1" (2.5 cm) long using the two holes in the bottom of the channel resting on frame. (See FIG.6 following)

FIG.5

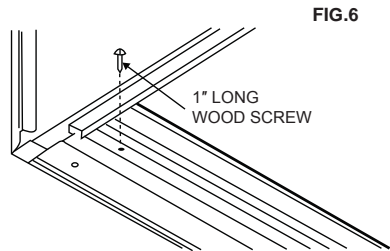
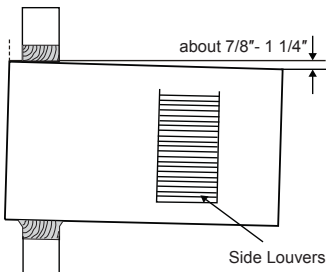

Refer to Step 5 of Window Mounting for assembly of support brackets. Nail a wooden strip to the outside wall for the angle sill bracket to rest upon. See Fig. 7.

5. Screw or nail cabinet to wooden frame using shims as needed to eliminate cabinet distortion. See Fig. 8. Remember to maintain proper tilt as described in Step 3.

Installation Instructions

FIG.7

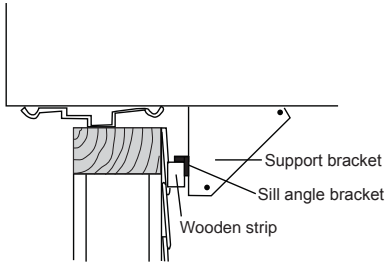
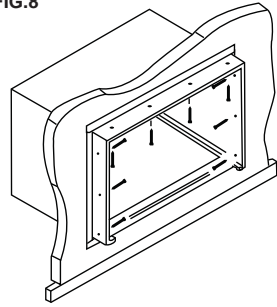

FIG.8



6. Install air conditioner into cabinet by following all steps in Step 9 of Window Mounting.

OPTIONAL: Caulking and installation of trim on interior wall may be done. You can buy wood from your local lumber or hardware supply. On the outside, caulk openings around top and sides of cabinet, and all sides of wood sleeve to the opening.

NOTE:

- See Step 5, Item 4 of Window Mounting Instructions for bottom rail seal location.

Masonry Construction

1. Cut or build a wall opening in the masonry wall similar to the frame construction (refer to Step 2 of Thru-the-Wall Installation for a wall thickness greater than 8-1/2").
2. Secure cabinet in place using masonry nails, or the right masonry anchor screws. (Another way to secure cabinet is to build a frame in the masonry wall such as the one shown in Fig. 3 of Step 2 Prepare Wall. Securely anchor frame to masonry wall. This way gives very good louver clearance on either side of cabinet.)
3. Install a lintel to support masonry wall above cabinet. Existing holes in cabinet can be used and/or additions holes can be drilled to fasten cabinet at various positions. Be sure that side louver clearance is in accordance with Step 1 Select Wall Location.
4. Install exterior cabinet support brackets as shown in Step 3 of Thru-the-Wall Installation. Caulk or flash if needed, to provide a weather-tight seal around top and sides of cabinet.
5. To complete installation, apply wood trim molding around room side projection of cabinet.