



PermaBASE Building Products

Construction Guide



PermaBASE

The Best Base for a Great Finish

PermaBASE Building Products, LLC offers the industry's largest variety of cement boards covering the most demanding interior and exterior applications. Our mission is to continue to innovate new products and solutions to serve the industry.

The PermaBASE family of products provide performance and peace of mind with valuable features and applications that save the contractor time and money.

We innovated the use of lightweight polystyrene beads within our Portland cement core to provide performance benefits unique to the PermaBASE family of products.

- The use of polystyrene aggregate makes PermaBASE products significantly lighter and easy to cut.
- The beads also contribute to the industry's lowest water absorption, preventing the adhering mortar from drying prematurely.

These products provide the industry's best warranties with a lifetime limited interior warranty and 15-year limited exterior warranty.

We have the size you need, and the product quality you expect for all your applications.



RESISTS MOISTURE

- Stays intact when exposed to water: will not rot, disintegrate or swell – built for the long run.
- Achieves the industry's lowest water-absorption rating (ASTM C473) – offering better installation.
- Helps inhibit mold growth with the highest possible score on mold tests (ASTM D3273 and ASTM G21).



STAYS STRONG AND LASTS LONG

- Resists impact and remains dimensionally stable – extending the life of your project.
- Holds up to the toughest conditions.



EDGETECH® REINFORCED EDGE

- Strong, reinforced edge that reduces damage from handling.
- Allows fasteners to be installed closer to the edge without fracturing like other cement boards.
- More comfortable to handle.



GREENGUARD GOLD CERTIFIED

- All PermaBASE products have achieved GREENGUARD GOLD Certification for low chemical emissions to help indoor air quality.
- PermaBASE Building Products is committed to supporting sustainable green building policies, standards and practices.



VERSATILE

- One panel, many applications.
- Adhere tile, stone or thin brick directly to PermaBASE products in exterior applications – saving time and money.
- Durable substrate for direct-applied coating systems.



INSTALLS QUICKLY

- Lightweight and easy to cut – speeding up installation.
- Reduces job site waste – easier, cleaner cut.



FIRE-RATED WALL ASSEMBLIES

- UL fire-rated wall assemblies.
- NFPA 285 approvals.
- Approved for non-combustible construction.



BEST-IN-CLASS WARRANTY

- Lifetime limited warranty: Interior applications.
- 15-year limited warranty: Exterior applications.

Working Wherever Your Project Takes You

Choose from Six Types of PermaBASE® Cement Board to Find the Best Match for Your Project.

PermaBASE CEMENT BOARD

- 1 The original that set the industry standard.

PermaBASE ULTRA BACKER CEMENT BOARD

- 2 Excellent rigidity for underlayment applications plus the lowest water-absorption rate.

PermaBASE INSULATED CI CEMENT BOARD

- 3 Composite cement board with R-4, R-10 or R-16 insulation to improve energy efficiency.

PermaBASE PLUS CEMENT BOARD

- 4 Weighs 15% less than other cement boards.

PermaBASE WATERPROOF WP CEMENT BOARD

- 5 Waterproof core for wet areas where waterproof applications are desired.

PermaBASE FOAM TILE BACKER

- 6 Ultra lightweight for easy installation.



A Solution for Any Application

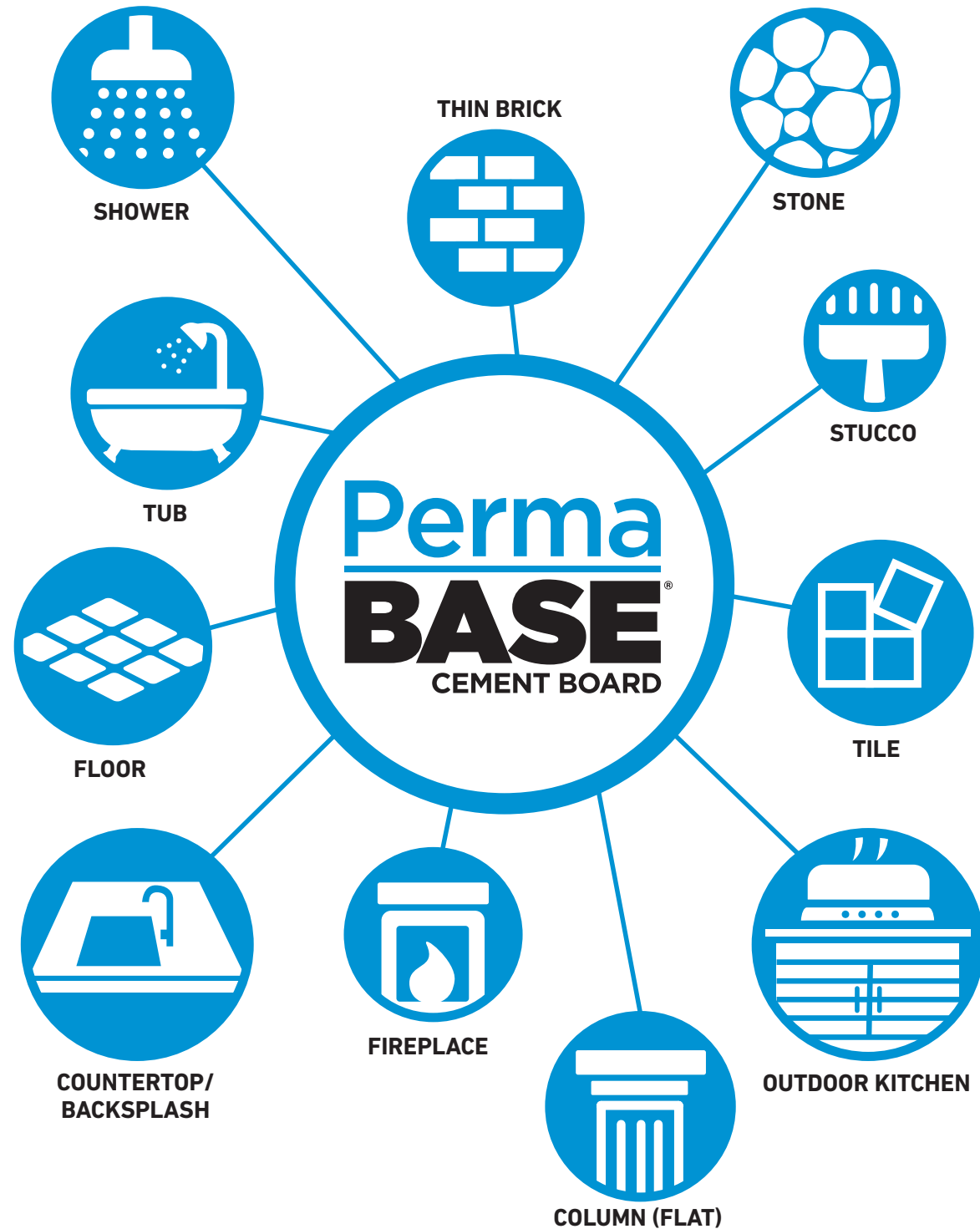

What Sets PermaBASE Products Apart From the Rest?

Physical Feature Benefits	PermaBASE Cement Boards	Other Cement Boards	Fiber Cement Boards
Low-Weight Glass-Mesh Cement Board	•	-	-
Reinforced Edge	•	-	-
Fastens Near Edge With No Breakout	•	-	-
Highest Damage Resistance From Handling	•	-	-
Cleanest To Score And Snap	•	-	-
Lowest Water Absorption	•	-	-
Meets 40-psf Rating Wind-Load Test Results (Stud spacing 16" o.c.)	•	-	-
Cuts With Utility Knife Vs. Power Tools	•	-	-
Standard Fasteners Countersink Into Board	•	•	-
Can Be Used In Both Residential and Commercial Steam Rooms And Saunas	•	•	-
Inorganic Vs. Organic Core	•	•	-
Lifetime Limited Warranty For Interior Use	•	•	-
15-Year Warranty For Exterior Use	•	-	-

• Standard Feature - Nonstandard Feature

PHYSICAL PROPERTIES

Property Method	Test	1/4"	1/2" PLUS	1/2"	5/8"
Water Absorption % By Weight/24 Hours	ASTM C473	<8	<10	<8	<8
Flexural Strength (psi)	ASTM C947	>1750	>750	>750	>1000
Fastener Holding (Wet And Dry, lbs.) (0.400" head diameter)	ASTM D037	>85	>90	>90	>90
Weight (psf)	ASTM C473	1.8	2.4	2.9	3.65
Freeze/Thaw (Cycles)	ASTM C666	100	100	100	100
Flame Spread/Smoke Developed	ASTM E84	0/0	0/0	0/0	0/0
Compressive Strength (psi) (Indentation)	ASTM D2394	N/A	N/A	1450	1250
Wind Load	ASTM E330	N/A	30	40	40
Thermal "R"/ k Value	Property of Material	0.2/2.7	0.28/2.7	0.37/2.7	0.47/2.7
Linear Variation (Due to Change in Moisture Content)	ASTM D1037	<0.07%	<0.05%	<0.05%	<0.05%
Fungus Resistance	ASTM G21	(No Growth)	(No Growth)	(No Growth)	(No Growth)
Mold Growth On Surface	ASTM D3273*	10	10	10	10
Shear Bond Strength (7 Days psi) Modified Dry-Set Cement Mortar	ANSI A118.4	>50	>50	>50	>50

*When tested by an independent laboratory per ASTM D3273 ("Standard Test Method for Resistance to Growth of Mold on the Surface of Interior Coatings in an Environmental Chamber"), PermaBASE Cement Board achieved a panel score of 10, the highest score possible, indicating no mold growth under the laboratory test conditions. The use of PermaBASE Cement Board in actual installations may not produce the same results as were achieved in controlled laboratory conditions. No material can be considered "mold proof," nor is it certain that any material will resist mold indefinitely.

PermaBASE® Cement Board

The Professional's Choice

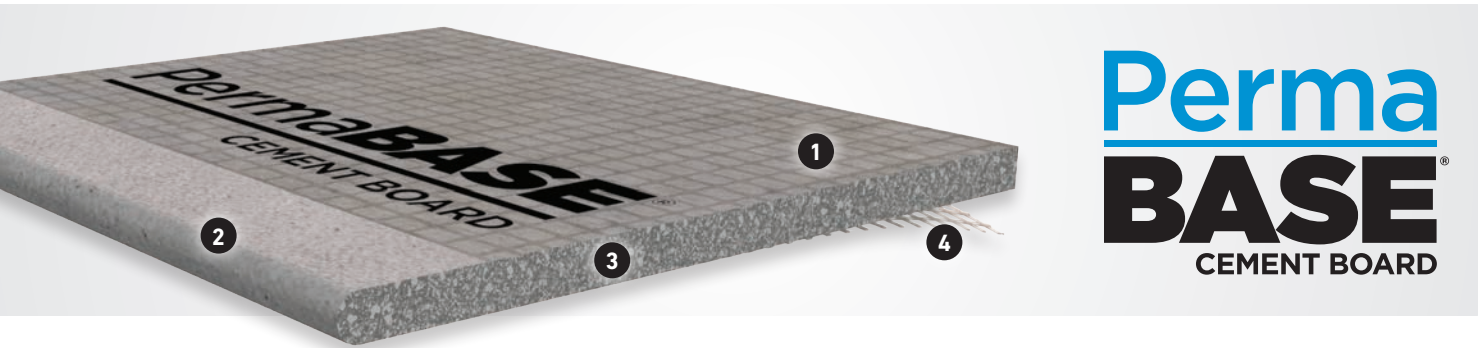

PermaBASE® Cement Board is a rigid substrate made of Portland cement, aggregate and glass mesh that provides an exceptionally hard, durable surface that withstands prolonged exposure to moisture. Use PermaBASE as an underlayment or backing surface for tub and shower surrounds, floors and a variety of other interior and exterior applications. The EdgeTech reinforced edges allow for more secure application of fasteners closer to the edge.



1. Fiberglass Mesh
2. EdgeTech® Reinforced Edge
3. Cementitious Core
4. Fiberglass Mesh

ADVANTAGES

- Stays intact when exposed to water: will not rot, disintegrate or swell – built for the long run.
- Achieves the industry's lowest water-absorption rating (ASTM C473) – offering better installation.
- Helps inhibit mold growth with the highest possible score on mold tests (ASTM D3273 and ASTM G21).
- Resists impact and remains dimensionally stable – extending the life of your project.
- Holds up to the toughest conditions.
- Lightweight and easy to cut – speeding up installation.
- Reduces job site waste – easier, cleaner cut.
- Durable substrate for direct-applied coating systems.
- Meets UL classifications for one- and two-hour fire-rated assemblies.
- Building code approved – one substrate that does the job of many.
- Lifetime limited warranty: Interior applications.
- 15-year limited warranty: Exterior applications.

APPLICATIONS

Product	Floors	Countertops	Walls	Ceilings	Exteriors
1/2" PermaBASE	●	●	●	●	●
5/8" PermaBASE	●	●	●	●	●
	● Recommended	- Not Recommended			

SIZES AND PACKAGING

Thickness, Width and Length	Pieces per Unit
1/2" x 32" x 5' (12.7 mm x 813 mm x 1,524 mm)	50*
1/2" x 32" x 8' (12.7 mm x 813 mm x 2,438 mm)	50
1/2" x 36" x 5' (12.7 mm x 914 mm x 1,524 mm)	50
1/2" x 36" x 6' (12.7 mm x 914 mm x 1,829 mm)	50*
1/2" x 48" x 8' (12.7 mm x 1,219 mm x 2,438 mm)	30
5/8" x 48" x 8' (15.9 mm x 1,219 mm x 2,438 mm)	24
5/8" x 36" x 5' (15.9 mm x 914 mm x 1,524 mm)	35
3/8" x 36" x 5' (9.5 mm x 914 mm x 1,524 mm)	50*
3/4" x 48" x 8' (19.0 mm x 1,219 mm x 2,438 mm)	20*
1" x 32" x 8' (25.4 mm x 813 mm x 2,438 mm)	20*

* Special Order



For installation instructions, see pages 16-23.

PermaBASE UltraBacker®

The Best Rigid 1/4" Underlayment

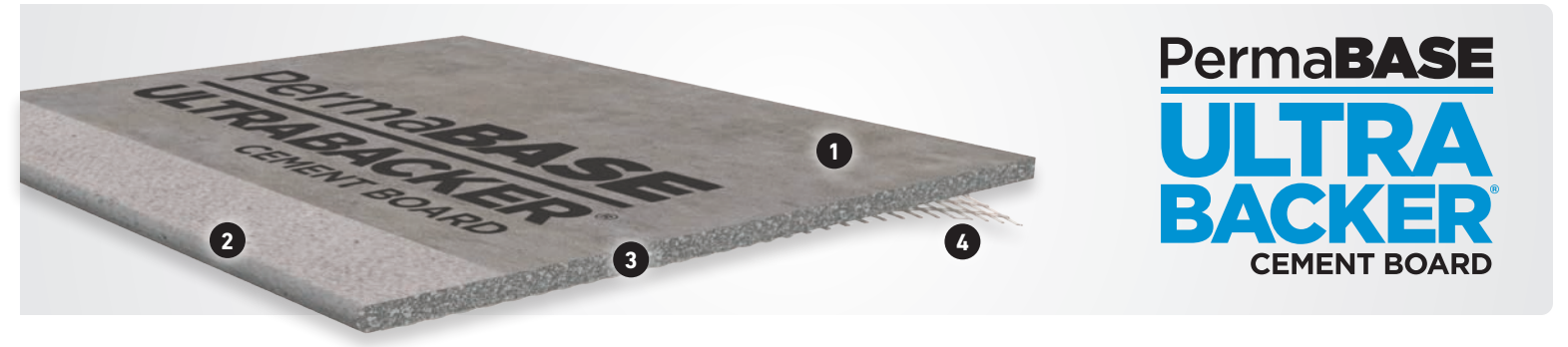

PermaBASE UltraBacker® Cement Board features a smooth mesh and mat surface that creates a more rigid and easier to handle product and an improved surface providing superior tile bond. Made of Portland cement, aggregate and fiberglass mesh, it provides an exceptionally hard, durable surface that is ideally suited as an underlayment for ceramic tile on floors, countertops, tub decks, and outdoor kitchen counters.

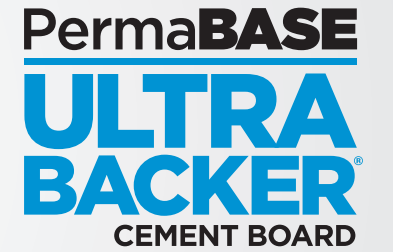

1. Fiberglass Mesh/Mat
2. EdgeTech® Reinforced Edge
3. Cementitious Core
4. Fiberglass Mesh

ADVANTAGES

- Features lowest water-absorption rating of <8% (ASTM C473).
- Stays intact when exposed to water; will not rot, disintegrate or swell.
- Helps inhibit mold growth with the highest possible score on mold tests (ASTM D3273 and ASTM G21).
- Resists impact and remains dimensionally stable.
- Holds up to toughest conditions.
- Can be applied over new or existing countertops or as flooring underlayment.
- Pre-manufactured panels save you time.
- Lifetime limited warranty: Interior application.

APPLICATIONS

Product	Floors	Countertops	Walls	Ceilings	Exteriors
1/4" PermaBASE UltraBacker	●	●	-	-	-
	● Recommended	- Not Recommended			

SIZES AND PACKAGING

Thickness, Width and Length	Pieces per Unit
1/4" x 36" x 5' (7.9 mm x 914 mm x 1,524 mm)	60



For installation instructions, see page 18.

PermaBASE CI™

The Best for Continuous Insulation Systems

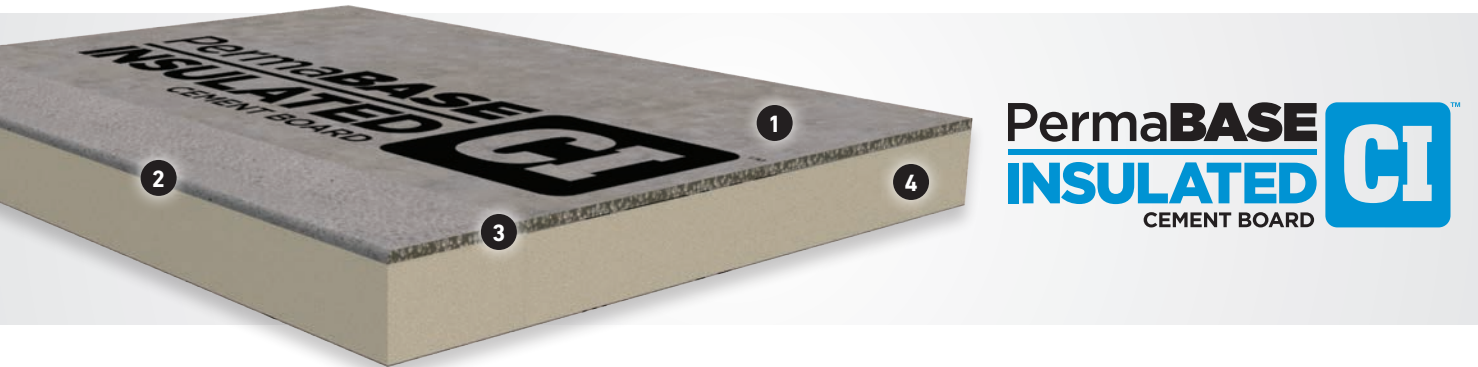

PermaBASE CI™ Insulated Cement Board is a composite cement board combining the strength and benefits of PermaBASE® Cement Board with rigid insulation to create an ideal substrate for exterior finishes that meet or exceed most continuous insulation requirements. Manufactured in a convenient 1", 2" and 3" overall thickness, PermaBASE CI utilizes common trims and accessories.

1. Fiberglass Mesh/Mat
2. EdgeTech® Reinforced Edge
3. Cementitious Core
4. Insulation

ADVANTAGES

- Made with PermaBASE Cement Board and high-density polyiso insulation to provide durability and highly efficient insulation in one convenient package.
- Saves time and labor compared to installing separate insulation and cement board solutions.
- NFPA 285 approvals for adhered veneer finishes such as manufactured and natural stone, thin brick and tile as well as direct applied coatings of synthetic stucco.
- 15-year limited warranty: Exterior applications.

APPLICATIONS

Product	Floors	Countertops	Walls	Ceilings	Exteriors
PermaBASE CI	-	-	-	-	•
	• Recommended	- Not Recommended			

TECHNICAL DATA

Property	Method	1"	2"	3"
Dimensional Stability	ASTM D2126	<0.5%	<0.5%	<0.5%
Water Absorption	ASTM C209	<5.0%	<5.0%	<5.0%
Water Vapor Transmission	ASTM E96	<1.5 perm	<1.5 perm	<1.5 perm
Flame Spread	ASTM E84	<25	<25	<25
Smoke Developed	ASTM E84	<450	<450	<450
R-Value	ASTM C518	4	10	16
Dimensions	ASTM C473	1" x 48" x 8'	2" x 48" x 8'	3" x 48" x 8'
Weight (lbs. / sq. ft.)		2.2	2.4	2.6

SIZES AND PACKAGING

Thickness, Width and Length	Pieces per Unit
1" x 48" x 8' (25.4 mm x 1,219 mm x 2,438 mm)	30*
2" x 48" x 8' (50.8 mm x 1,219 mm x 2,438 mm)	20
3" x 48" x 8' (76.2 mm x 1,219 mm x 2,438 mm)	15*

* Special Order



For installation instructions, see pages 24-25.

PermaBASE PLUS®

The Lightweight Cement Board Alternative

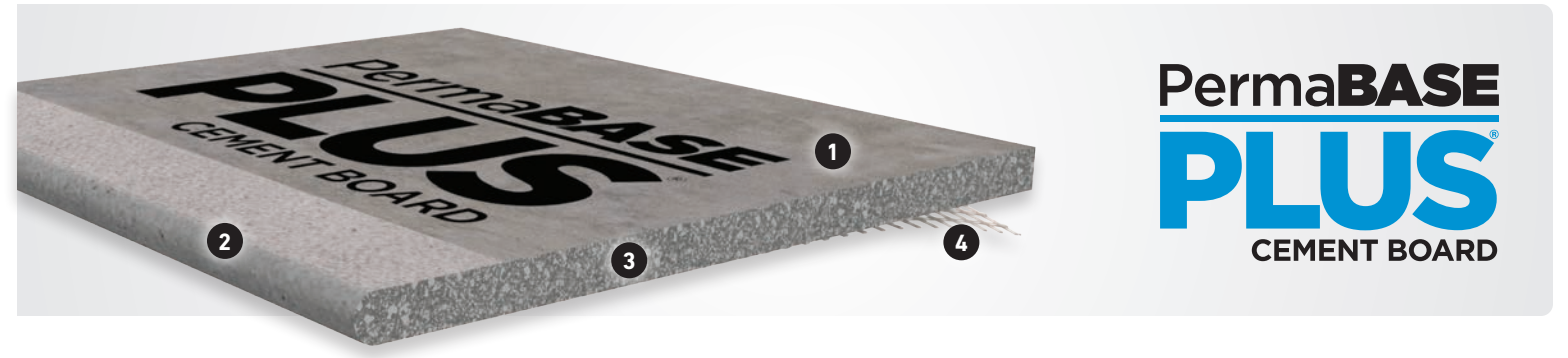

PermaBASE PLUS® Cement Board is a lighter weight, rigid substrate made of Portland cement aggregate and glass mesh that provides an exceptionally hard, durable surface that is able to withstand prolonged exposure to moisture. PermaBASE PLUS Cement Board has the same qualities built into PermaBASE Cement Board but weighs 15% less. EdgeTech® Reinforced Edge allows for more secure application of fasteners closer to the edge.

1. Fiberglass Mesh/Mat
2. EdgeTech® Reinforced Edge
3. Cementitious Core
4. Fiberglass Mesh

ADVANTAGES

- Stays intact when exposed to water; will not rot, disintegrate or swell – built for the long run.
- Achieves the industry's lowest water-absorption rating (ASTM C473) – offering better installation.
- Helps inhibit mold growth with the highest possible score on mold tests (ASTM D3273 and ASTM G21).
- Resists impact and remains dimensionally stable – extending the life of your project.
- Holds up to toughest conditions.
- Lightweight and easy to cut – speeding up installation.
- Reduces job site waste – easier, cleaner cut.
- Meets UL classifications for one- and two-hour fire-rated assemblies.
- Lifetime limited warranty: Interior applications.
- 15-year limited warranty: Exterior applications.

APPLICATIONS

Product	Floors	Countertops	Walls	Ceilings	Exteriors
1/2" PermaBASE PLUS	•	•	•	•	•
	• Recommended	- Not Recommended			

SIZES AND PACKAGING

Thickness, Width and Length	Pieces per Unit
1/2" x 36" x 5' (12.7 mm x 914 mm x 1,524 mm)	50
1/2" x 48" x 8' (12.7 mm x 1,219 mm x 2,438 mm)	40*

* Limited geographic availability



For installation instructions, see page 16.

PermaBASE WP™

Your Solution for Waterproof Applications

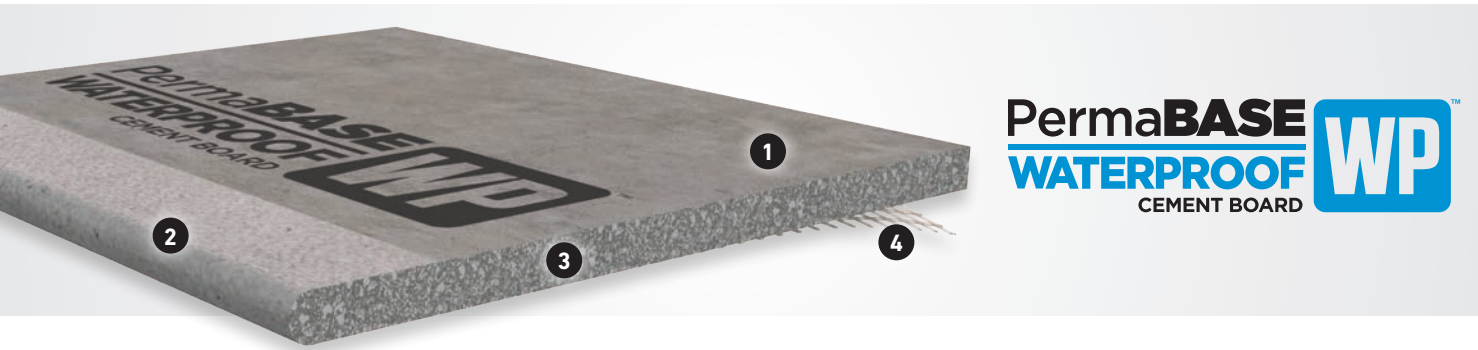

PermaBASE WP™ Waterproof Cement Board combines the strength and benefits of PermaBASE® Cement Board with a proprietary waterproofing formulation. Intended for use in interior wet areas around tubs and showers, PermaBASE WP is perfect for instances where liquid waterproofing has historically been applied over cement boards.



1. Fiberglass Mesh/Mat
2. EdgeTech® Reinforced Edge
3. Cementitious Core
4. Fiberglass Mesh

ADVANTAGES

- Waterproof core prevents water from causing harmful damage.
- Passes ANSI A118.10 for waterproofness.
- Helps inhibit mold growth with the highest possible score on mold tests (ASTM D3273 and ASTM G21).
- Smooth surface; strong bond.
- Lightweight and easy to cut.
- Lifetime limited warranty: Interior applications.

APPLICATIONS

Product	Floors	Countertops	Walls	Ceilings	Exteriors
1/2" PermaBASE WP	●	●	●	●	–
	● Recommended	– Not Recommended			

SIZES AND PACKAGING

Thickness, Width and Length	Pieces per Unit
1/2" x 36" x 5' (12.7 mm x 914 mm x 1,524 mm)	50



Installation of PermaBASE WP

General: All framing should comply with local building code requirements and be designed to provide support with a maximum allowable deflection of L/360 (L/720 for stone) under all intended loads. Wall framing members shall be spaced a maximum of 16" o.c. and shall be a minimum of 2" x 4" nominal (wood) or 20 gauge (metal).

For flooring applications with 16" o.c. floor joists, 5/8" tongue-and-groove exterior-grade plywood or 3/4" tongue-and-groove exterior-grade OSB may be used. For 19.2" o.c. and 24" o.c. floor joists, 3/4" tongue-and-groove exterior-grade plywood or OSB must be used. Tile size for floors with 24" o.c. floor joists must be 12" x 12" or larger. The joist and subfloor assembly must meet L/360 (L/720 for stone) as well as the appropriate code tables for live and dead loads. Install tile and tile setting materials in accordance with current ANSI specifications and Tile Council of North America (TCNA) guidelines.

Control Joints: Consult TCNA Handbook Installation Method EJ171. Architect, builder or design professional must specify location of all control joints. For interior installations, allow a maximum of 30 lineal feet between control joints. A control joint must be installed but not limited to the following locations: where expansion joints occur in the framing or building (discontinue all cross-furring members located behind joint); when boards abut dissimilar materials; where framing material changes; at changes of building shape or structural system; at each story separation. Place control joints at corners of window and door openings, or follow specifications of architect. Control joint cavity shall not be filled with coating or other materials.

WALLS

Wall Framing: Edges of PermaBASE WP parallel to framing should be continuously supported. Provide additional blocking when necessary to permit proper attachment. Do not install PermaBASE WP directly over protrusions from stud plane, such as heavy brackets and fastener heads. Studs above a shower floor should either be notched or furred to accommodate the thickness of the waterproof membrane or pan. The surround opening for a tub or precast shower receptor should not be more than 1/4" longer than unit to be installed. In mortar bed (mud bed) applications, PermaBASE Cement Boards can be embedded into the mud bed per TCNA Handbook method B415-19.

PermaBASE WP: Apply PermaBASE WP with ends and edges closely butted but not forced together. Stagger end joints in successive courses. Drive fasteners into field of board first, working toward ends and edges. Space fasteners maximum 8" o.c. for walls, with perimeter fasteners at least 1/2" and less than 3/4" from ends and edges. Ensure PermaBASE WP is tight to framing. Install screws flush with surface, do not overdrive screws.

Joint Reinforcement: Trowel bonding material to completely fill the board joints and gaps between each panel. Apply a 6" wide, approx. 1/16" thick coat of bonding material over entire joint. For all joints, immediately embed 2" alkali-resistant fiberglass mesh tape fully into applied bonding material and allow it to cure. For outside corners, 4" wide alkali-resistant mesh tape is recommended. Same bonding material should be applied to corners, control joints, trims and other accessories. Feather bonding material over fasteners to fully conceal. Bonding material to be modified dry set mortar compliant with ANSI A118.4 standards. In wet-area installations, apply approved



fluid applied waterproofing per manufacturer's recommendations over entire surface to receive tile.

Sealant/Waterproofing Application: In areas where waterproof performance is required, apply approved liquid waterproofing/sealant over cement board joints and fastener heads/penetrations, as well as any exposed edges. Waterproofing must extend past treated joint onto PermaBASE WP surface a minimum of 2" on either side of the joint. This includes inside and outside corners. Follow waterproofing manufacturer's instructions on application requirements. Once all board joints have been treated following this procedure, seal all fasteners with approximately a 2" diameter coating of liquid waterproofing or approved sealant.

FLOORS AND COUNTERS

Subfloor or Base: For flooring applications with 16" o.c. floor joists, 5/8" tongue-and-groove exterior-grade plywood or 3/4" tongue-and-groove exterior-grade OSB may be used. For 19.2" o.c. and 24" o.c. floor joists, 3/4" tongue-and-groove exterior-grade plywood or OSB must be used. Tile size for floors with 24" o.c. floor joists must be 12" x 12" or larger. The joist and subfloor assembly must meet L/360 as well as the appropriate code tables for live and dead loads.

Underlayment: Using a 1/4" square-notched trowel, apply a setting bed of polymer-modified mortar (or thin-set mortar) to the subfloor or counter base. Immediately laminate PermaBASE WP to subfloor or base with ends and edges closely butted but not forced together. Leave a 1/4" gap along walls. Stagger all joints so that they do not line up with underlying substrate joints. Fasten PermaBASE WP every 8" o.c. throughout board field and around all edges while setting bed mortar is still workable. Around perimeter of each board, locate fasteners 2" from corners and not less than 3/8" from the edges. Fill all joints solid with bonding material. On non-tapered joints such as butt ends, apply a 6" wide, 1/16" thick coat over the entire joint. For all joints, immediately embed 2" alkali-resistant fiberglass mesh tape fully into applied bonding material; ensure that tape is centered over joint. Apply bonding material over fasteners to fully conceal. Remove all excess bonding material and allow to cure.

PermaBASE™ Foam Tile Backer

Lightest & Easiest Tile Backer to Install

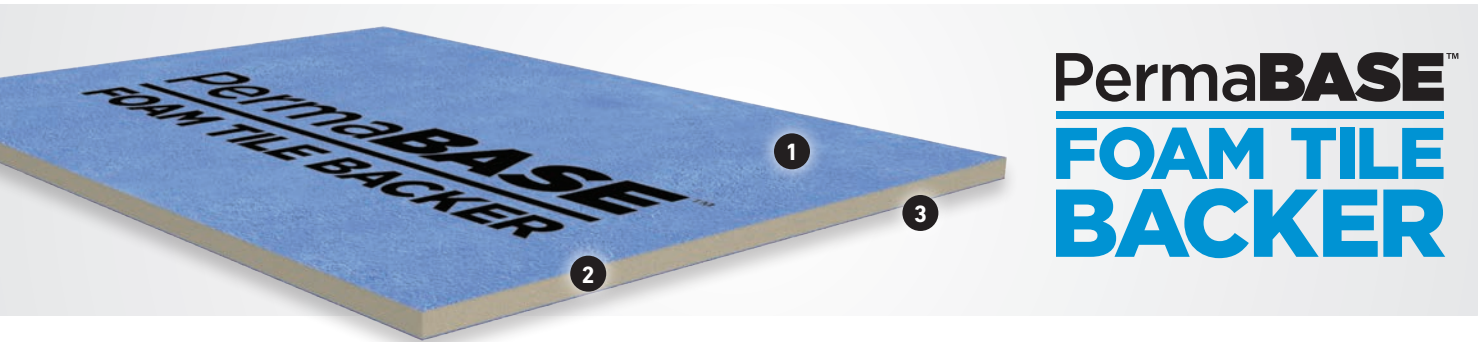

PermaBASE™ Foam Tile Backer is an exceptionally lightweight, durable waterproof tile backer board designed for interior tile and stone applications. It is ideally suited for walls, showers, tub surrounds, backsplashes, floors and countertops.

1. Coated Fiberglass Facer
2. Lightweight Foam Core
3. Coated Fiberglass Facer

ADVANTAGES

- Waterproof tile backer prevents water from causing harmful damage.
- Passes ANSI A118.10 for waterproofness.
- Mold resistant per UL 2824.
- Made from a high-density foam with specially coated facers.
- Ultra-lightweight, yet durable enough for demanding applications.

APPLICATIONS

Product	Floors	Countertops	Walls	Ceilings	Exteriors
1/2" Foam Tile Backer	●	●	●	●	–
	● Recommended	– Not Recommended			

SIZES AND PACKAGING

Thickness, Width and Length	Pieces per Unit
1/2" x 36" x 5' (15.8 mm x 914 mm x 1,524 mm)	60
1/2" x 48" x 8' (15.8 mm x 1,219 mm x 2,438 mm)	60



TECHNICAL DATA

Property	Method	Results
Dimensional Stability	ASTM D2126	<0.5%
Compression Strength	ASTM D1621	Grade 1
Water Absorption	ASTM C209	<3.0%
Water Vapor Transmission	ASTM E96	<1.5 perm
Flame Spread	ASTM E84	40
Smoke Developed	ASTM E84	<450
R-Value	ASTM C518	2.5
Mold Resistant	UL 2818	Yes
Weight (lbs. / sq. ft.)		.40

Installation of PermaBASE™ Foam Tile Backer

General: All framing should comply with local building code requirements and be designed to provide support with a maximum allowable deflection of L/360 (L/720 for stone) under all intended loads. Wall framing members shall be spaced a maximum of 16" o.c. and shall be a minimum of 2"x 4" nominal (wood) or 20 gauge (metal). Install tile and tile setting materials in accordance with current ANSI specifications and Tile Council of North America (TCNA) guidelines.

Control Joints: Consult TCNA Handbook Installation Method EJ171. Architect, builder or design professional must specify location of all control joints. For interior installations, allow a maximum of 30 lineal feet between control joints. A control joint must be installed but not limited to the following locations: where expansion joints occur in the framing or building (discontinue all cross-furring members located behind joint); when boards abut dissimilar materials; where framing material changes; at changes of building shape or structural system; at each story separation. Place control joints at corners of window and door openings or follow specifications of architect. Control joint cavity shall not be filled with coating or other materials.

WALLS

Wall Framing: Edges of PermaBASE Foam Tile Backer parallel to framing should be continuously supported. Provide additional blocking when necessary to permit proper Foam Tile Backer attachment. Do not install PermaBASE Foam Tile Backer directly over protrusions from stud plane, such as heavy brackets and fastener heads. Studs above a shower floor should either be notched or furred to accommodate the thickness of the waterproof membrane or pan. The surround opening for a tub or precast shower receptor should not be more than 1/4" longer than unit to be installed.

Floors and Counters: (Subfloor or Base) For flooring applications with 16" o.c. floor joists, 5/8" tongue-and-groove exterior-grade plywood or 3/4" tongue-and-groove exterior-grade OSB may be used. For 19.2" o.c. and 24" o.c. floor joists, 3/4" tongue-and-groove exterior-grade plywood or OSB must be used. Tile size for floors with 24" o.c. floor joists must be 12" x 12" or larger. The joist and subfloor assembly must meet L/360 as well as the appropriate code tables for live and dead loads.

Underlayment: Using a 1/4" square-notched trowel, apply a setting bed of polymer-modified mortar (or thin-set mortar) to the subfloor or counter base. Immediately laminate Foam Tile Backer to subfloor or base with ends and edges closely butted but not forced together. Leave a 1/4" gap along walls. Stagger all joints so that they do not line up with underlying substrate joints. Fasten tile backer every 8" o.c. throughout board field and around all edges while setting bed mortar is still workable. Around perimeter of each board, locate fasteners 2" from corners and not less than 3/8" from the edges. Fill all joints solid with bonding material. On non-tapered joints such as butt ends, apply a 6" wide, 1/16" thick coat over the entire joint. For all joints, immediately embed 2" alkali-resistant fiberglass mesh tape fully into applied bonding material; ensure that tape is centered over joint. Apply bonding material over fasteners to fully conceal. Remove all excess bonding material and allow to cure.

Ceiling Installation: The deflection of the complete ceiling assembly due to dead load (including insulation, Foam Tile Backer, bonding material and facing material) should not exceed L/360. The dead load applied to the ceiling frame should not exceed 7.5 pounds per square foot. Ceiling joist or furring channel should not exceed 16" o.c. (Edges of foam tile backer parallel to framing should be continuously supported.) Provide additional blocking when necessary to permit proper Foam Tile Backer attachment.

PermaBASE Foam Tile Backer: Cut PermaBASE Foam Tile Backer using a utility knife to score/cut through the entire board. Apply Foam Tile Backer with ends and edges closely butted but not forced together. Stagger ends joints in successive courses. For ceiling applications, an approved metal foam board washer is required to be used with the screws to attach Foam Tile Backer. Drive fasteners into field of board first, working toward ends and edges. Space fasteners maximum 8" o.c. for walls, with perimeter fasteners at least 1/2" and less than 3/4" from ends and edges. Ensure Foam Tile Backer is tight to framing. Install screws flush with surface, do not overdrive screws.

Joint Reinforcement: Trowel bonding material to completely fill the board joints and gaps between each panel. Apply a 6" wide, approx. 1/16" thick coat of bonding material over entire joint. For all joints, immediately embed 2" alkali-resistant fiberglass mesh tape fully into applied bonding material and allow it to cure. For outside corners, 4" wide alkali-resistant mesh tape is recommended. Same bonding material should be applied to corners, control joints, trims and other accessories. Feather bonding material over fasteners to fully conceal. Bonding material to be modified dry set mortar compliant with ANSI A118.4 standards. In wet-area installations, apply approved fluid applied waterproofing per manufacturer's recommendations over joints and fastener heads.

Alternate Sealant/Waterproofing Application: Apply continuous bead of approved sealant to the bottom edge of PermaBASE Foam Tile Backer. Install board and ensure that when it is butted at the base, the sealant squeezes out. There must be at least 1/8" gap between Foam Tile Backer and base that is completely filled with sealant. Sealant must extend onto Foam Tile Backer surface a minimum of 1" beyond joint on either side. Fasten Foam Tile Backer to the studs with approved cement board fasteners flush to the surface of the board at a maximum spacing of 6" and within 1/2"-1" of the perimeter edges.

Apply a continuous bead of sealant to the top edge so that when PermaBASE Foam Tile Backer is butted the sealant squeezes out. Ensure a tight seal at the joint. Fasten Foam Tile Backer to the studs and spread any excess sealant with a putty knife across both sides of joint. Sealant must cover joints to at least 1" beyond either side of the joint.

Once all boards have been installed following this procedure, seal all fasteners with approximately a 2" diameter coating of sealant. Seal all corner joints. All joints should be completely filled with sealant and sealant spread minimum 1" beyond either side of joint.

Installation Guide

Interior and Exterior Applications



Interior Installation of PermaBASE® and PermaBASE PLUS®

General: All framing should comply with local building code requirements and be designed to provide support with a maximum allowable deflection of L/360 (L/720 for stone) under all intended loads. Framing members should be spaced a maximum of 16" o.c. Cut or score PermaBASE® Cement Board on printed side of panel. Use a straightedge and pencil to mark line. Use utility knife to score/cut the glass mesh. Snap the board and cut through the now visible glass mesh on the other side. Install tile and tile setting materials in accordance with current ANSI specifications and Tile Council of North America (TCNA) guidelines.

Control Joints: Consult TCNA Handbook Installation Method EJ171. Architect, builder or design professional must specify location of all control joints. For interior installations, allow a maximum of 30 lineal feet between control joints. A control joint must be installed but not limited to the following locations: where expansion joints occur in the framing or building (discontinue all cross furring members located behind joint); when boards abut dissimilar materials; where framing material changes; at changes of building shape or structural system; at each story separation. Place control joints at corners of window and door openings, or follow specifications of architect. Control joint cavity shall not be filled with coating or other materials.

WALLS AND CEILINGS

Wall Framing: Edges of PermaBASE parallel to framing should be continuously supported. Provide additional blocking when necessary to permit proper attachment. Do not install PermaBASE directly over protrusions from stud plane, such as heavy brackets and fastener heads. Studs above a shower floor should either be notched or furred to accommodate the thickness of the waterproof membrane or pan. The surround opening for a tub or precast shower receptor should not be more than 1/4" longer than unit to be installed. In mortar bed (mud bed) applications, PermaBASE Cement Boards can be embedded into the mud bed per TCNA Handbook method B415-19.

Ceiling Framing: The deflection of the complete ceiling assembly due to dead load (including insulation, PermaBASE, bonding material and facing material) should not exceed L/360. The dead load applied to the ceiling frame should not exceed 10 psf. Ceiling joist or furring channel should not exceed 16" o.c. (Edges of PermaBASE parallel to framing should be continuously supported.) Provide additional blocking when necessary to permit proper PermaBASE attachment.

PermaBASE Cement Board: Apply PermaBASE with ends and edges closely butted but not forced together. Stagger ends joints in successive courses. Drive fasteners into field of cement board first, working toward ends and edges. Space fasteners maximum 8" o.c. for walls, 6" o.c. for ceilings with perimeter fasteners at least 3/8" and less than 5/8" from ends and edges. Ensure PermaBASE is tight to framing.

Joint Reinforcement: Trowel bonding material to completely fill the tapered recessed board joints and gaps between each panel. On non-tapered joints, apply a 6" wide, approx. 1/16" thick coat of bonding material over entire joint. For all joints, immediately embed 2" alkali-resistant fiberglass mesh tape fully into applied bonding material and allow it to cure. For outside corners, 4" wide mesh tape is recommended. Same bonding material should be applied to corners, control joints, trims and other accessories. Feather bonding material over fasteners to fully conceal.

For installation accessories, see page 20.

**Perma
BASE**
CEMENT BOARD

**PermaBASE
PLUS**
CEMENT BOARD



SHOWER INSTALLATION

1. Support Framing 1/4" / 1/2" Slope Toward Drain
2. Plywood, Min. 1/2"
3. PermaBASE® Cement Board
4. Membrane
5. Latex-Portland Cement Mortar
6. Alkali-Resistant Mesh Tape
7. Sealant
8. Tile and Grout



DIVIDER WALL INSTALLATION

1. PermaBASE® Cement Board
2. Membrane
3. Latex-Portland Cement Mortar
4. Alkali-Resistant Mesh Tape

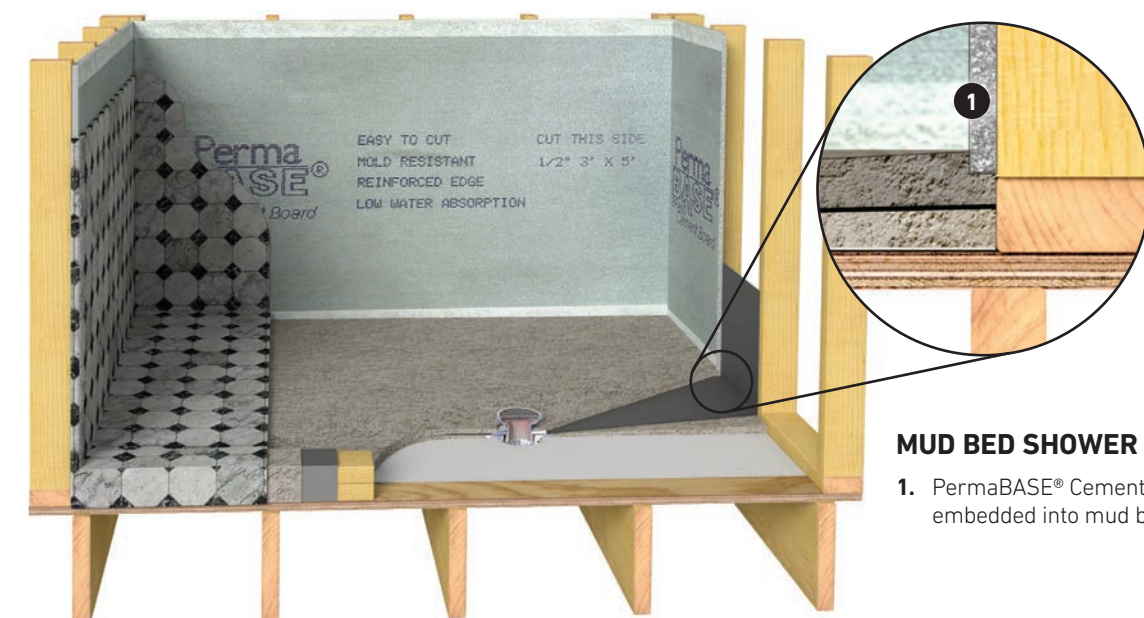

MUD BED SHOWER BASE

1. PermaBASE® Cement Board can be embedded into mud bed.

FLOORS AND COUNTERS

Subfloor or Base: For flooring applications with 16" o.c. floor joists, 5/8" tongue-and-groove exterior-grade plywood or 3/4" tongue-and-groove exterior-grade OSB may be used. For 19.2" o.c. and 24" o.c. floor joists, 3/4" tongue-and-groove exterior-grade plywood or OSB must be used. Tile size for floors with 24" o.c. floor joists must be 12" x 12" or larger. The joist and subfloor assembly must meet L/360 as well as the appropriate code tables for live and dead loads.

Underlayment: Using a 1/4" square-notched trowel, apply a setting bed of polymer-modified mortar (or thin-set mortar) to the subfloor or counter base. Immediately laminate PermaBASE® Cement Board to subfloor or base with ends and edges closely butted but not forced together. Leave a 1/4" gap along walls. Stagger all joints so that they do not line up with underlying substrate joints. Fasten PermaBASE Cement Board every 8" o.c. throughout board field and around all edges while setting bed mortar is still workable. Around perimeter of each board, locate fasteners 2" from corners and not less than 3/8" from the edges. Fill all joints solid with bonding material. On non-tapered joints such as butt ends, apply a 6" wide, 1/16" thick coat over the entire joint. For all joints, immediately embed 2" fiberglass mesh tape fully into applied bonding material; ensure that tape is centered over joint. Apply bonding material over fasteners to fully conceal. Remove all excess bonding material and allow to cure.

LIMITATIONS

- Joints should be treated with alkali-resistant fiberglass mesh tape set in a polymer-modified mortar.
- Conventional paper drywall tape, joint compound and drywall nails or screws should not be used.
- Maximum wall framing spacing should not exceed 16" o.c. and must be designed to limit deflection to L/360 under all live and dead loads.
- Steel framing must be 20 gauge (galvanized) or heavier – 16" o.c.
- 1/4" UltraBacker should not be used on walls or ceilings.
- PermaBASE Cement Board is not a water barrier; consult local building code for moisture barrier requirements.
- Not recommended for use under vinyl flooring.
- PermaBASE Cement Board should not be exposed to temperatures over 220°F (105°C).
- PermaBASE Cement Board is not a nailing base for other finishes.



COUNTERTOP INSTALLATION

1. OSB/Plywood
2. Dry-Set Mortar
3. PermaBASE Cement Board
4. Fiberglass Mesh Tape (Alkali-Resistant) Embedded in Mortar
5. Dry-Set Mortar
6. Tile

FLOOR UNDERLAYMENT

1. Joists
2. Subfloor
3. Dry-Set Mortar
4. PermaBASE Cement Board
5. Fiberglass Mesh Tape (Alkali Resistant)
6. Dry-Set Mortar
7. Tile

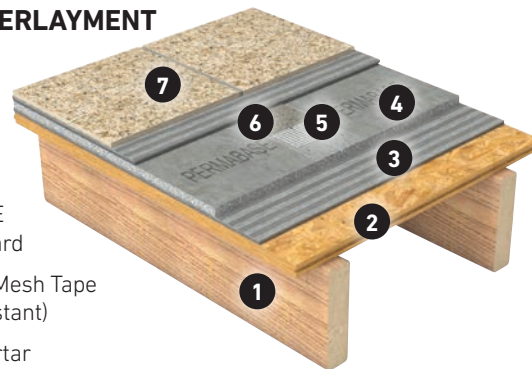

FLOOR UNDERLAYMENT

1. Open-Web Wood Trusses
2. Subfloor
3. Dry-Set Mortar
4. PermaBASE Cement Board
5. Mesh Tape
6. Dry-Set Mortar
7. Mortar Bed
8. Tile

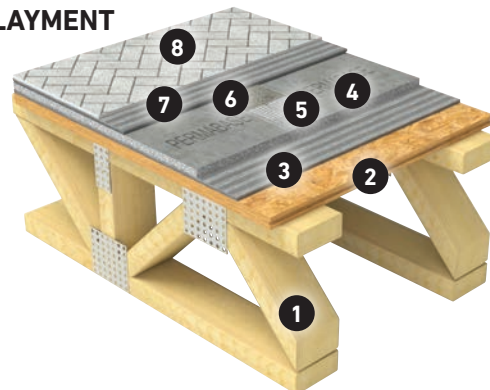

Wall Protector/Heat Shield

1/2" PermaBASE and 1/2" PermaBASE PLUS are listed by Underwriters Laboratories, Inc., for use with UL-listed solid-fuel room heaters and fireplace stoves. Used as a wall protector/heat shield, PermaBASE Cement Board reduces by 40 percent the manufacturer-specified clearance (minimum 12" [305 mm]) between the room heater or stove and a combustible wall surface.

Installation: Furring is made by cutting a full PermaBASE panel into 4" (102 mm) wide strips with a carbide-tipped saw or utility knife. Attach a double layer of furring strips to the wall studs using cement board screws, which provide a minimum penetration of 3/4" (19.1 mm) into the framing.

When installing panels, leave a 3" (76.2 mm) gap at the ceiling and 1" (25.4 mm) to 2" (50.8 mm) gap at the floor. This air space is required for the proper functioning of the heat shield. Do not close or block these openings.

Heat shield panels may be cut to required size using a standard utility knife or power saw. Fasten the PermaBASE panels to the studs with galvanized roofing nails or cement board screws spaced 8" (203 mm) o.c. Cement board screws must be long enough to penetrate into framing a minimum of 3/4" (19.1 mm). Do not install any nails or screws into the wall area directly behind the proposed location of the appliance.

Finishing: Prefill joints with dry-set mortar, then immediately embed PermaBASE™ Cement Board Tape and level joints. As an alternative, apply PermaBASE Tape over the joints, then apply dry-set mortar, forcing it through the tape to completely fill and level the joints. All non-combustible finishes, such as ceramic tile, thin brick or stone, can be applied over wall-shield.

Do not apply combustible finishes, such as wallpaper, to cement board surface.



1. Studs Spaced 16" o.c.
2. Existing Gypsum Board
3. Two Layers 4" Wide Furring Strips
4. PermaBASE Heat Shield
5. Joint Treatment
6. Fasteners Spaced 8" o.c. Maximum
7. 1/2" Minimum Clearance from the Floor

PermaBASE Cement Board heat shielding permits clearance reduction up to 40 percent of the manufacturer's suggested clearance.

Fastener Spacing



- 1. Ceilings** - Fasten PermaBASE a maximum of every 6" o.c. into existing ceiling framing.
- 2. Walls** - Fasten PermaBASE a maximum of every 8" o.c. into existing wall framing.
- 3. Floors** - Fasten PermaBASE a maximum of every 8" o.c. throughout board field and around all edges.

SCREWS NEEDED

Usage	Screws per Board	Screws per Sq. Ft.
4' x 8' PermaBASE		
Wall	52	1.65
Ceiling	63	2.00
Floor	91	2.85
3' x 5' PermaBASE		
Wall	36	2.40
Ceiling	35	2.35
Floor	54	3.60

MESH TAPE NEEDED (EST.)

Tape Size	Linear Ft. per Board	Linear Ft. per Sq. Ft.
4' x 8' PermaBASE		
2" or 4"	12	0.375
3' x 5' PermaBASE		
2" or 4"	8	0.533
Tape Size	# Rolls per 1,000 Sq. Ft. of Board	# Boards per Roll of Tape
4' x 8' PermaBASE		
2" x 50'	.75	4.167
4" or 150'	2.5	12.500
3' x 5' PermaBASE		
2" x 50'	10.7	6.250
4" or 150'	3.6	18.750

Installation Accessories

For a seamless installation, we recommend PermaBASE™ Cement Board Tape and PermaBASE™ Cement Board Screws.

Fasteners: PermaBASE corrosion-resistant screws or equivalent, 1-1/4", 2" or 2-1/2" long, for use with wood framing. Type S-12 screws or equivalent, 1-1/4", 2" or 2-1/2" long, for use with 20-gauge or heavier steel framing. Galvanized roofing nails, 1-1/2" long with hot-dipped galvanized coating for use with wood framing. Nails should meet Federal Specification #FF-N105B/type 2 style 20.

Joint Reinforcement: PermaBASE Cement Board Tape must be used on all edges and cuts made to size. Use 2" wide polymer-coated (alkali-resistant) mesh tape for interior applications and 4" wide polymer-coated (alkali-resistant) mesh tape is recommended for inside and outside corners and all exterior applications.



Exterior Installation of PermaBASE® Cement Board

General: All framing should comply with local building code requirements and be designed to provide support with a maximum allowable deflection of L/360 under all intended live (including wind) and dead loads.

Note: Cut or score PermaBASE on rough side of panel.

Control Joints: For exterior installations, consult finish manufacturer's instructions for spacing requirements. For exterior tile applications, control joints should be spaced a maximum of every 12'. If no recommendation is available, allow a maximum of 16 lineal feet between control joints. A control joint must be installed but not limited to the following locations: where expansion joints occur in the framing or building (discontinue all cross furring members located behind joint); when boards abut dissimilar materials; where framing material changes; at changes of building shape or structural system; at each story separation. Place control joints at corners of window and door openings or follow specifications of architect. Control joint cavity shall not be filled with coating or other materials.

WALLS AND CEILINGS

Wall Framing: Studs should be spaced a maximum of 16" o.c. Edges/ends of PermaBASE parallel to framing should be continuously supported. Provide additional blocking when necessary to permit proper PermaBASE attachment. Do not install PermaBASE directly over protrusions from stud plane such as heavy brackets or fastener heads.

Ceiling Framing: The deflection of the complete ceiling assembly due to dead load (including insulation, PermaBASE, bonding material and facing material) should not exceed L/360. The dead load applied to the ceiling frame should not exceed 10 psf. Ceiling joist or furring channel should not exceed 16" o.c. (Edges of PermaBASE parallel to framing should be continuously supported.) Provide additional blocking when necessary to permit proper PermaBASE attachment.

Water Barrier: While PermaBASE is unaffected by moisture, a water/air resistive barrier (WRB) must be installed to protect the cavity. The type and specific placement or location of the water barrier will vary based on local building codes and/or manufacturers' warranties. Consult the WRB manufacturer's recommendations for specific installation guidelines.

PermaBASE Cement Board: Apply PermaBASE with ends and edges closely butted but not forced together. Stagger end joints in successive courses. Drive fasteners into field of cement board first, working toward ends and edges. Space fasteners maximum 8" o.c. for walls, 6" o.c. for ceilings with perimeter fasteners at least 3/8" and less than 5/8" from ends and edges.

Joint Reinforcement: Trowel bonding material to completely fill the tapered recessed board joints and gaps between each panel. On non-tapered joints, apply a 6" wide, approximately 1/16" thick coat of bonding material over entire joint. For all joints, immediately embed 4" alkali-resistant fiberglass mesh tape fully into applied bonding material and allow to cure. Same bonding material should be applied to corners, control joints, trims or other accessories. Feather bonding material over fasteners to fully conceal.

Perma
BASE
CEMENT BOARD



DECKS

Subfloor: Plywood should be securely glued and fastened to floor joists spaced a maximum of 16" o.c. Subfloor should be sloped at a minimum pitch of 1/4" per foot. The floor surface should be true to plane within 1/8" in 10'.

Underlayment: Using a 1/4" square-notched trowel, apply a setting bed of dry-set mortar to the subfloor. Immediately laminate PermaBASE to subfloor, leaving a 1/8" space between boards at all joints and corners. Leave a 1/4" gap along walls. Stagger joints so they do not line up with underlying substrate joints. Fasten PermaBASE every 8" o.c. throughout board field and around all edges while setting bed mortar is still workable. Around perimeter of each board, locate fasteners 2" from the corners and not less than 3/8" from the edges. Fill all joints solid with bonding material. On non-tapered joints such as butt ends, apply a 6" wide, 1/16" thick coat over the entire joint. For all joints, embed alkali-resistant fiberglass mesh tape fully into applied bonding material; ensure that tape is centered over joint. Apply bonding material over fasteners to fully conceal. Remove all excess bonding material and allow it to cure.

Waterproof Membrane: Trowel apply waterproof membrane to the entire surface of the cement board, following membrane manufacturer's installation instructions in detail.

Cement Board Stucco Wall Systems (CBSS)

For use in residential and low-rise commercial applications, CBSS provides a drainage system to help prevent water from penetrating behind cladding in framed construction. It complies with ASTM D226, protecting approved sheathings/structural components and helping to evacuate incidental water.

BENEFITS INCLUDE

- Appropriate for all climates and resists the growth of mold and mildew.
- Extremely durable with increased resistance to impact and inclement weather.
- Acrylic polymers provide more resistance to fading, cracking and peeling.
- Engineered system that allows a faster installation while providing superior quality control (manufactured product that must comply with ASTM product specifications).
- Speed up your schedule – easier, cleaner installation than traditional stucco.
- Provide drainage system to help prevent water from penetrating behind cladding in framed construction.
- Choose from a variety of textures and color options.
- Provides a 15-year exterior warranty.

LIMITATIONS

- Follow finish material manufacturer's instructions for proper installation.
- Treat joints in PermaBASE Cement Board with mesh tape and base coat.
- Thin veneer construction can reveal planar irregularities in framing.
- Minor cracking at joints may become visible in finished exterior surface.
- Exterior finishes applied directly to PermaBASE Cement Board: Reinforcing mesh must be embedded in base coat (consult exterior finish manufacturer for additional installation requirements).
- Conventional Portland cement plaster systems: Self-furring metal lath must be used over PermaBASE Cement Board and fastened to studs.
- Code-approved water/air resistive barrier (WRB) must first be installed to protect the cavity (type and placement will vary per local building codes and/or manufacturer's specifications, installation guidelines and warranties).

CEMENT BOARD STUCCO Commercial

1. Sheathing
2. Weather Resistant Barrier
3. PermaBASE® Cement Board
4. Mesh Tape
5. Base Coat
6. Reinforcing Mesh
7. Optional Primer Coat
8. Finish Coat
9. Flashing Tape
10. Weep Screed

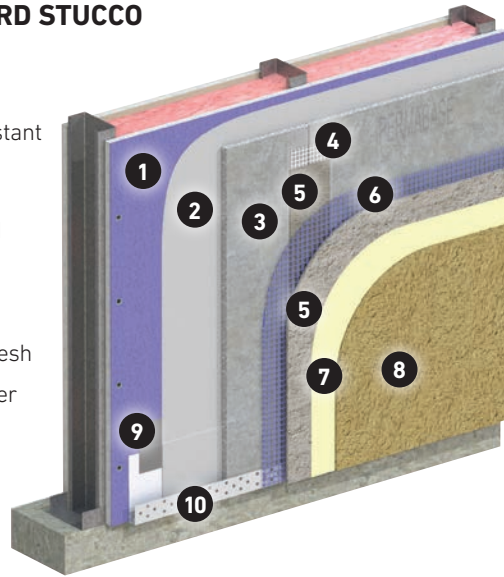

CEMENT BOARD STUCCO Residential

1. Wood Sheathing
2. Weather Resistant Barrier
3. PermaBASE® Cement Board
4. Mesh Tape
5. Base Coat
6. Reinforcing Mesh
7. Optional Primer Coat
8. Finish Coat
9. Flashing Tape
10. Weep Screed

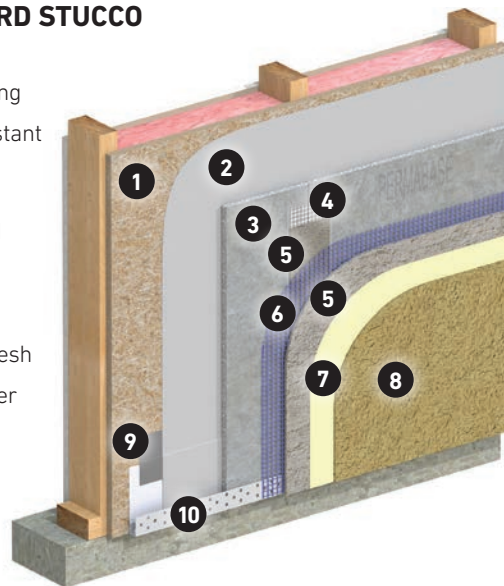

Cement Board Masonry Veneer Wall System (CBMV)

For use in residential and low-rise commercial applications, CBMV offers a complete, engineered solution for installation of adhered veneers. It provides the ability to incorporate an effective water-management system for a variety of building exteriors with manufactured or natural stone, tile and thin brick veneers.

BENEFITS INCLUDE

- Engineered system that allows a faster installation while providing superior quality control (manufactured product that must comply with ASTM product specifications).
- Increased performance by utilizing modified adhesive mortars (designed for hanging materials) rather than type S&N mortars (developed for stacking materials).
- Extremely durable with increased resistance to impact and inclement weather.
- Approved for use in ASTM 1780, and cement board is cited as an approved substrate for this system by the Masonry Veneer Manufacturers Association (MVMA): Installation Guide and Detailing Options for Compliance with ASTM C1780.
- Easily allows for the inclusion of continuous installation into the assembly.
- Appropriate for all climates, and resists the growth of mold and mildew.
- Speed up your schedule – faster, easier and cleaner than traditional metal lath/scratch-coat method.
- IBC/IRC compliant; meets ASTM C1325.
- PermaBASE products are approved as a substrate for direct applied finishes, tile, stone and thin brick in exterior applications, as outlined in UL Evaluation Report ER-22158.
- PermaBASE products are suitable for use in combustible and noncombustible construction under the IBC and IRC, as outlined in UL Evaluation Report ER-22158.

LIMITATIONS

- Sheathing selection and installation varies according to type of wall construction.
- Code-approved water/air resistive barrier (WRB) must be installed to protect the cavity (type and placement will vary per local building codes and/or manufacturer's specifications, installation guidelines and warranties).

CEMENT BOARD MASONRY VENEER Thin Brick

1. Sheathing
2. Weather Resistant Barrier
3. PermaBASE® Cement Board
4. Mesh Tape
5. Mortar
6. Thin Brick Veneer
7. Flashing Tape
8. Weep Screed

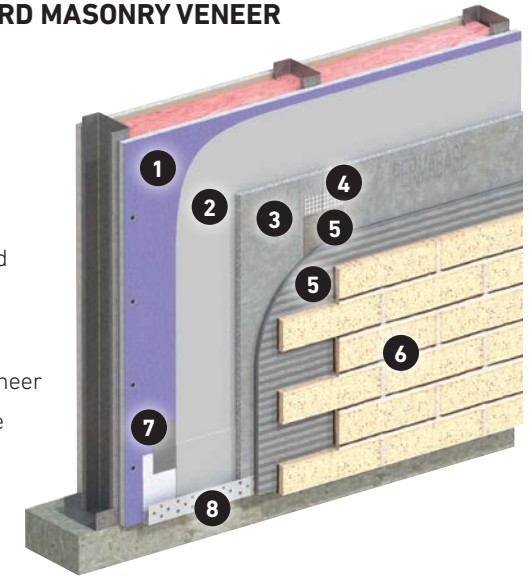

CEMENT BOARD MASONRY VENEER Stone

1. Sheathing
2. Weather Resistant Barrier
3. PermaBASE® Cement Board
4. Mesh Tape
5. Mortar
6. Thin Stone Veneer
7. Flashing Tape
8. Weep Screed

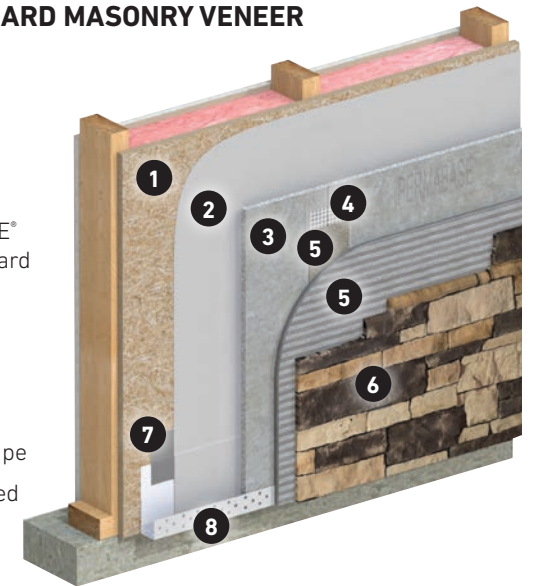

Exterior Installation of PermaBASE CI™

WALLS

Wall Framing: Framing members should be spaced a maximum of 16" o.c. and shall be a minimum of 2"x 4" nominal (wood) or 20 gauge (metal). Edges of PermaBASE CI™ Insulated Cement Board parallel to framing should be continuously supported. Provide additional blocking when necessary to permit proper attachment.

Water Barrier: While PermaBASE CI Insulated Cement Board is unaffected by moisture, a water/air resistive barrier (WRB) must be installed to protect the cavity. The type and specific placement or location of the water barrier will vary based on local building codes and/or manufacturers' specifications, installation guidelines and warranties. Consult the WRB manufacturer's recommendations for specific installation guidelines.

PermaBASE CI Insulated Cement Board:

Note: PermaBASE CI can be cut using three methods:

1. Score PermaBASE CI from the foam side using a utility knife to score/cut completely through the insulation and into the back of the cement board. The board can then be snapped. Cut through the mesh on the front of board to complete the cut.
2. PermaBASE CI can be cut to length effectively with a hand saw.
3. While wearing the proper protective equipment such as safety glasses and approved respirator, use a power saw with the appropriate blade to cut through the entire panel. Penetrations can be created in the panel with a drywall saw.

Apply PermaBASE CI with ends and edges closely butted, but not forced, together. Stagger end joints in successive courses. Drive fasteners into field of cement board first, working toward ends and edges. Space fasteners maximum 8" o.c. with perimeter fasteners at least 3/8" and less than 5/8" from ends and edges. Ensure PermaBASE CI Insulated Cement Board is tight to framing. Do not overdrive screws to the point they penetrate the fiberglass mesh in PermaBASE CI.

Joint Reinforcement: Trowel bonding material to completely fill the tapered recessed board joints and gaps between each panel. On non-tapered joints, apply a 6" wide, approx. 1/16" thick, coat of bonding material over entire joint. For all joints, immediately embed 4" alkali-resistant fiberglass mesh tape fully into applied bonding material and allow to cure. Same bonding material should be applied to corners, control joints, trims or other accessories. Feather bonding material over fasteners to fully conceal.

Control Joints: For exterior installations, consult finish manufacturer for spacing requirements. For exterior tile applications, control joints should be spaced a maximum of every 12'. If no recommendation is available, allow a maximum of 16 lineal feet between control joints. A control joint must be installed but not limited to the following locations: where expansion joints occur in the framing or building (discontinue all cross-furring members located behind joint); when boards abut dissimilar materials; where framing material changes; at changes of building shape or structural system; at each story separation. Place control joints at corners of window and door openings or follow specifications of architect. Control joint cavity shall not be filled with coating or other materials.



LIMITATIONS

- Treat joints with 4" wide alkali-resistant fiberglass mesh tape set in a modified mortar or stucco basecoat.
- Steel framing must be minimum 20-gauge (galvanized) (.0312" design thickness) or heavier.
- Do not expose PermaBASE CI to temperatures over 220°F (105°C).
- Do not use PermaBASE CI as a nailing base for other finishes.
- Thin veneer construction can reveal planar irregularities in framing.
- Minor cracking at joints may become visible in finished exterior surface.
- For exterior finishes applied directly to PermaBASE CI, reinforcing mesh must be embedded in basecoat (consult exterior finish manufacturer for additional installation requirements).
- Sheathing selection and installation varies according to type of wall construction.

Advantages of Creating Continuous Insulation with PermaBASE:

- Provides better thermal comfort, lowers heating and cooling costs, reduces likelihood of trapped moisture.
- Helps mitigate the loss of heat/air conditioning by insulating the studs.
- Allows multiple finishes on one substrate.
- Works in all climates – adaptable to varying regional system requirements.
- 15-year exterior warranty.
- Speeds up your schedule – faster to install than traditional method.

Continuous Insulation with PermaBASE CI

As building codes and building insulation requirements become increasingly stringent, you can count on PermaBASE products to help meet your substrate needs for Continuous Insulation (CI). CI on the exterior envelope helps to eliminate air and moisture leakage as well as reduce thermal bridging, or the heating/cooling loss transmitted through steel studs. With PermaBASE CI, designers and contractors have a simpler, faster method of achieving continuous insulation. PermaBASE® Cement Board has also been used for years to install the final exterior finish over the exterior insulation in applications including Z-furring channels, batten strips and direct fastener applications. PermaBASE CI and PermaBASE Cement Board can be used in all types of construction, including commercial, residential and multi-family.

- | | |
|---|------------------|
| 1. Sheathing | 5. Mesh Tape |
| 2. Weather Resistant Barrier | 6. Mortar |
| 3. Drainage | 7. Thin Brick |
| 4. PermaBASE CI™ Insulated Cement Board | 8. Flashing Tape |
| | 9. Weep Screed |

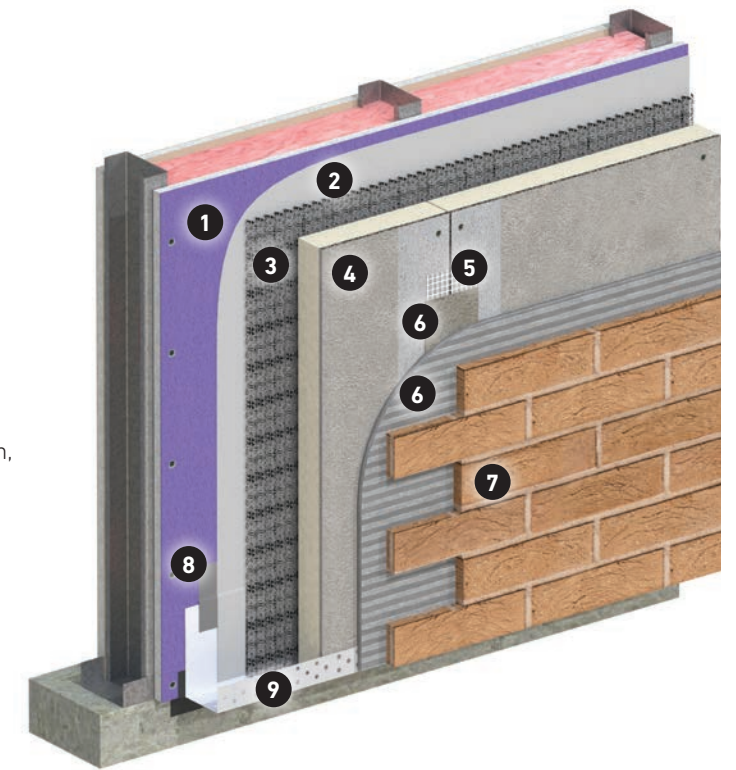

Alternative Methods to Achieve Continuous Insulation with PermaBASE

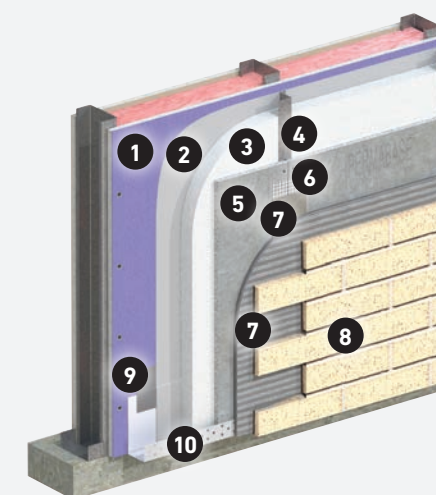

CONTINUOUS INSULATION Z Furring-Installation

- | | |
|------------------------------|----------------------|
| 1. Sheathing | 6. Mesh Tape |
| 2. Weather Resistant Barrier | 7. Mortar |
| 3. Insulation | 8. Thin Brick Veneer |
| 4. Z-Furring | 9. Flashing Tape |
| 5. PermaBASE® Cement Board | 10. Weep Screed |

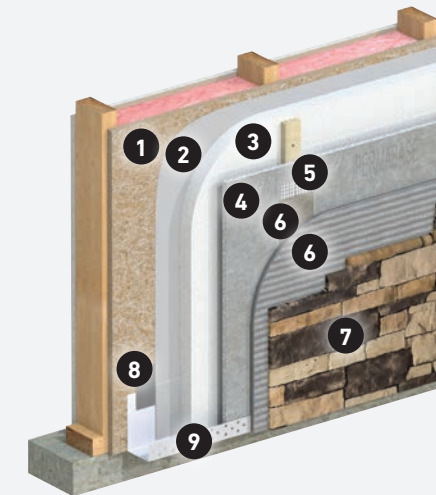

CONTINUOUS INSULATION Batten Strip

- | | |
|------------------------------|----------------------|
| 1. Sheathing | 5. Mesh Tape |
| 2. Weather Resistant Barrier | 6. Mortar |
| 3. Insulation | 7. Thin Stone Veneer |
| 4. PermaBASE® Cement Board | 8. Flashing Tape |
| | 9. Weep Screed |

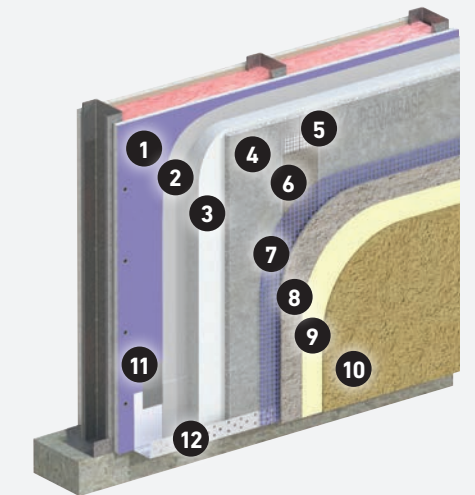

CONTINUOUS INSULATION Specialty Fastener

- | | |
|------------------------------|-------------------|
| 1. Sheathing | 6. Base Coat |
| 2. Weather Resistant Barrier | 7. Mesh |
| 3. Insulation | 8. Base Coat |
| 4. PermaBASE® Cement Board | 9. Primer |
| 5. Mesh Tape | 10. Finish Coat |
| | 11. Flashing Tape |
| | 12. Weep Screed |

Technical Data

Fire-Rated Wall Assemblies

PermaBASE® Cement Board has been tested and/or approved for use in a variety of fire-rated wall systems.

UL LISTED PERMABASE® CEMENT BOARD PARTITIONS – STEEL FRAMING

1-hour Fire Rating
V452 UL Design
W472 UL Design



1/2" PermaBASE® PLUS or 1/2" PermaBASE applied vertically or horizontally to one side of 3-5/8" steel studs 16" o.c. Gold Bond® Fire-Shield® 5/8" Gypsum Board applied vertically to opposite side. 3" mineral wool insulation in stud cavities.

1-hour Fire Rating
U425 UL Design

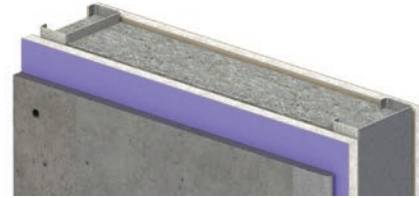

1/2" PermaBASE® PLUS or 1/2" PermaBASE applied vertically or horizontally over Gold Bond® Fire-Shield® 5/8" Gypsum Board or similar 5/8" fire-resistant gypsum board applied vertically to each side of 3-1/2", 20-gauge steel studs 16" o.c. PermaBASE secured to studs with cement board screws of adequate length to penetrate studs 3/8" spaced 8" o.c.

1-hour Fire Rating
V438 UL Design



1/2" PermaBASE® PLUS or 1/2" PermaBASE applied vertically or horizontally over Gold Bond® Fire-Shield® 5/8" Gypsum Board applied vertically to each side of 3-5/8" steel studs 16" o.c. PermaBASE secured to studs with cement board screws of adequate length to penetrate studs 3/8" spaced 8" o.c.

2-hour Fire Rating
V452 UL Design
W472 UL Design

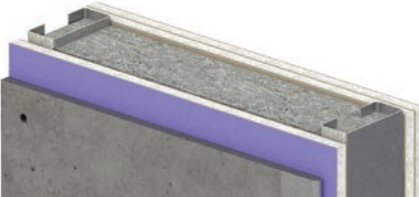

1/2" PermaBASE® PLUS or 1/2" PermaBASE applied vertically over Gold Bond® Fire-Shield C™ 1/2" Gypsum Board or Gold Bond® Fire-Shield® 5/8" Gypsum Board, applied vertically to one side of 3-5/8" steel studs 16" o.c. Two layers Gold Bond® Fire-Shield C™ 1/2" Gypsum Board or Gold Bond® Fire-Shield® 5/8" Gypsum Board applied vertically to opposite side. 3" mineral wool insulation in stud cavities.

1-hour Fire Rating
V452 UL Design
W472 UL Design

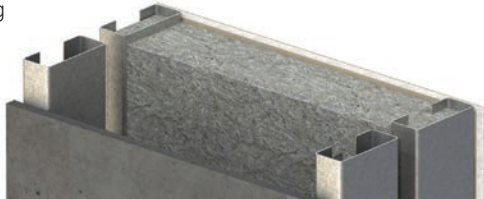

1/2" PermaBASE® PLUS or 1/2" PermaBASE applied vertically or horizontally to one side of double row of 3-5/8" steel studs 16" o.c. Gold Bond® Fire-Shield® 5/8" Gypsum Board applied vertically to opposite side. 3" mineral wool insulation in stud cavities.

2-hour Fire Rating
V438 UL Design



1/2" PermaBASE® PLUS or 1/2" PermaBASE applied horizontally or vertically over Gold Bond® Fire-Shield C™ 1/2" Gypsum Board or Gold Bond® Fire-Shield® 5/8" Gypsum Board, applied vertically to each side of 3-5/8" steel studs 16" o.c. 3" mineral wool insulation in stud cavities.

UL LISTED PERMABASE® CEMENT BOARD PARTITIONS – WOOD FRAMING

1-hour Fire Rating
U392 UL Design



1/2" PermaBASE® PLUS or 1/2" PermaBASE applied vertically or horizontally to one side of 2x4 wood studs 16" o.c. with 1-1/4" cement board screws spaced 8" o.c. ceramic tile installed over PermaBASE. Gold Bond® Fire-Shield® 5/8" Gypsum Board applied vertically or horizontally to opposite side with 6d nails spaced 7" o.c. 3-1/2" mineral wool insulation in stud cavities.

1-hour Fire Rating
U392 UL Design

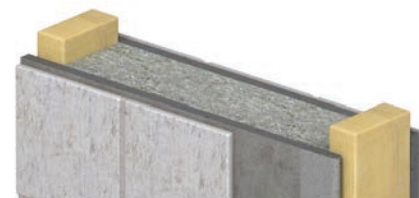

1/2" PermaBASE® PLUS or 1/2" PermaBASE applied vertically or horizontally to each side of 2x4 wood studs 16" o.c. with 1-1/4" cement board screws spaced 8" o.c. ceramic tile installed over PermaBASE. 3-1/2" mineral wool insulation in stud cavities.



National Gypsum Company

National Gypsum Company is the exclusive service provider of reliable, high-performance building products manufactured by its affiliate companies and marketed under the Gold Bond®, ProForm®, and PermaBASE® brands. The strategic network of Gold Bond, ProForm, and PermaBASE manufacturing facilities located throughout major metropolitan hubs in North America allows us to provide the best in customer service so we can keep your fast-paced projects moving forward.

SUSTAINABILITY

Our brands create products that contribute to sustainable design by providing healthy indoor air quality; moisture, mold and mildew management; durability; optimal acoustics; life safety and increased space functionality. No matter how you define sustainability, we offer the most comprehensive set of value-added solutions in the industry.

TRUSTED PARTNER

The National Gypsum name has been synonymous with high-quality, innovative products and exceptional customer service since 1925. Our technical experts at 1-800-NATIONAL® are always a phone call away to answer any type of product or specification question.

We are Building Products for a Better Future® - one project at a time.

LIMITED WARRANTY AND REMEDIES

Products manufactured by PermaBASE Building Products, LLC ("Seller") are warranted by Seller to its customers to be free from defects in materials and workmanship at the time of shipment. Additional or different express limited warranties, limitations and exclusions may apply to specific Seller products. **Current warranty information on such products for both commercial and residential applications is available at permabase.com.** THIS EXPRESS WARRANTY IS THE ONLY WARRANTY APPLICABLE TO SUCH PRODUCTS, AND IS IN LIEU OF AND EXCLUDES ALL OTHER EXPRESS ORAL OR WRITTEN WARRANTIES AND ALL IMPLIED WARRANTIES, INCLUDING BUT NOT LIMITED TO THE IMPLIED WARRANTIES OF MERCHANTABILITY AND FITNESS FOR A PARTICULAR PURPOSE.

Seller will not be liable for any incidental, indirect or consequential losses, damages or expenses. The customer's exclusive remedy for any type of claim or action for defective products will be limited to the replacement of the products (in the form originally shipped) or, at Seller's option, to a payment or credit not greater than the original purchase price of the products.

Seller will not be liable for products claimed to be defective where the defect resulted from causes not within Seller's control, or which arose or occurred after shipment, including but not limited to accidents, misuse, mishandling, improper installation, contamination or adulteration by other materials or goods, or abnormal conditions of temperature, moisture, dirt or corrosive matter.

Any claim that products sold by Seller were defective or otherwise did not conform to the contract of sale is waived unless the customer submits it in writing to National Gypsum Services Company d/b/a National Gypsum Company, authorized sales agent and service provider to Seller, within thirty (30) days from the date the customer discovered or should have discovered the defect or non-conformance. No legal action or proceeding complaining of goods sold by Seller may be brought by the customer more than one year after the date the customer discovered or should have discovered the defect or problem of which it complains.

MOLD AND MILDEW RESISTANCE

PermaBASE was designed to provide extra protection against mold and mildew. When tested by an independent laboratory, PermaBASE received the highest possible ratings on ASTM G 21 and D 3273. The use of PermaBASE in actual installations may not produce the same results as were achieved in controlled laboratory conditions.

No material can be considered "mold-proof," nor is it certain that any material will resist mold or mildew indefinitely. When used in conjunction with good design, handling and construction practices, PermaBASE can provide increased mold resistance. As with any building material, avoiding water exposure during handling, storage and installation, and after installation is complete, is the best way to avoid the formation of mold or mildew.

Technical Information

Visit permabase.com or call National Gypsum Company Construction Services: 1-800-NATIONAL (628-4662).

Technical Information Información Técnica

1-800-NATIONAL®

1-800-628-4662

National Gypsum Company is the exclusive service provider for products offered or manufactured by PermaBASE Building Products, LLC. The PermaBASE family of products is offered or manufactured by PermaBASE Building Products, LLC.

Customer Service

- Atlantic Area**
(800) 237-9167
atlanticareacsrs@nationalgypsum.com
- Central Area**
(800) 252-1065
centralareacsrs@nationalgypsum.com
- Gulf Area**
(800) 343-4893
gulfareacsrs@nationalgypsum.com
- Midwest Area**
(800) 323-1447
midwestareacsrs@nationalgypsum.com
- Northeast Area**
(800) 253-3161
northeastareacsrs@nationalgypsum.com
- Southeast Area**
(800) 548-9394
southeastareacsrs@nationalgypsum.com
- Southwest Area**
(800) 548-9396
southwestareacsrs@nationalgypsum.com
- Western Area**
(800) 824-4227
westernareacsrs@nationalgypsum.com

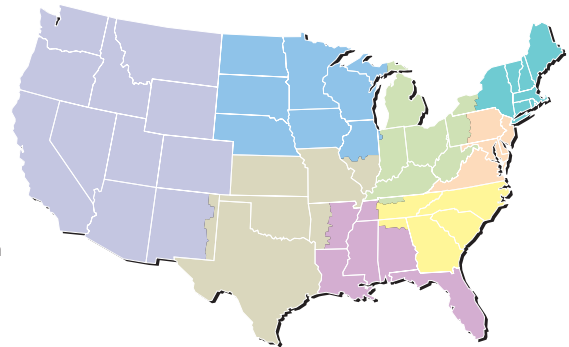

Industry Associations



Exclusive service provider of
PermaBASE Building Products, LLC

PermaBASE® Building Products

PermaBASE Building Products, LLC
2001 Rexford Road
Charlotte, NC 28211

704.365.7300
permabase.com