

SB-2400ER

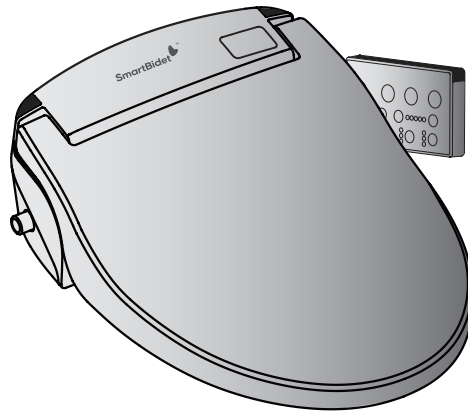

Contents

- This product was manufactured for household use only.
- Read all operating instructions before installation and use.
- Please save this operating instruction manual and place in an easily accessible location.
- Due to ongoing product improvements, external appearance and specifications are subject to change without notice.

Important Safeguards	2
Grounding Instructions	4
Parts Identification	5
Basic Instructions	7
Functions & Operation	8
Installing Unit	12
Trial Operation	16
Uninstalling Unit	17
Maintenance	18
Draining Bidet's Water Tank	20
Troubleshooting	21
Product Specifications	22
Warranty	23

IMPORTANT SAFEGUARDS

READ ALL INSTRUCTIONS BEFORE USING.

DANGER To reduce the risk of electrocution.

- Do not use while bathing.
- Do not place or store product where it can fall or be pulled into a tub or sink.
- Do not place in or drop into water or other liquid.
- Do not reach for a product that has fallen into water. Unplug immediately.

WARNING To reduce the risk of burns, electrocution, fire or injury to persons.

- Close supervision is necessary when this product is used by, on, or near children or invalids.
- Use this product only for its intended use as described in this manual. Do not use any attachments not recommended by the manufacturer.
- Never operate this product if it has a damaged cord or plug, if it is not working properly, if it has been dropped or damaged, or dropped into water. Return the product to a service center for examination and repair.
- Keep the cord away from heated surfaces.
- Never block the air openings of the product or place it on a soft surface, such as a bed or couch, where the air openings may be blocked. Keep the air openings free of lint, hair, and the like.
- Never use while sleeping or drowsy.
- Never drop or insert any object into any opening or hose.
- Do not use outdoors. or operate where aerosol(spray) products are being used or where oxygen is being administered.
- Connect this product to a properly grounded outlet only. See Grounding Instructions.
- Any other servicing should be performed by an authorized service representative.
- Do not dismantle, repair, or alter the unit.
- Do not pour or spray water on to the unit.
- The unit must be grounded.
- Do not touch the power plug with wet hands.
- Properly connect the power cord to the electrical outlet corresponding to the rated voltage of the unit.
- Do not use damaged or loose power cord.
- Do not use steam cleaner.
- Keep the unit away from fires or inflammable substance.
- Do not connect to the industrial water supplies.
- Do not connect other electrical appliances to the same power socket connected to the unit.
- Replace damaged power cord and plug by authorized service center.
- Caution against low temperature burns.
- Before removing the unit from the toilet bowl, disconnect the power plug first.

IMPORTANT SAFEGUARDS

CAUTION To reduce the risk of injury to persons or damage to the product or the property.

- **Do not place heavy objects or step on the unit.**
Doing so may cause product damage or injury.
- **When cleaning the unit, do not use any chemicals. Clean the unit with a moist, well-wrung soft cloth. For excessive stains, use a soft cloth moistened with mild dish washing detergent and wipe with a dry cloth.**
Using chemicals may cause product damage.
- **Do not slam the lid.**
Slamming the lid may cause product damage.
- **Do not lean on the lid.**
Leaning on the lid may cause product damage.
- **When not in use for a long period of time, disconnect the power plug.**
- **Do not twist or pull the connection hoses.**
Twisting or pulling may affect water supply or cause water leakage.
- **Do not cover the warm air outlet or insert hands or other objects.**
Doing so may cause burn or electric shock.
- **Do not operate the unit during product malfunction.**
Disconnect the power plug and call an authorized service provider.
Using a malfunctioning unit may cause fire or electrical shock.

SAVE THESE INSTRUCTIONS

INFORMATION TO THE USERS

This equipment has been tested and found to comply with the limits for a Class B digital device, pursuant to part 15 of the FCC Rules. These limits are designed to provide reasonable protection against harmful interference in a residential installation. This equipment generates, uses and can radiate radio frequency energy and, if not installed and used in accordance with the instructions, may cause harmful interference to radio communications. However, there is no guarantee that interference will not occur in a particular installation. If this equipment does cause harmful interference to radio or television reception, which can be determined by turning the equipment off and on, the user is encouraged to try to correct the interference by one more of the following measures:

- Reorient or relocate the receiving antenna.
- Increase the separation between the equipment and receiver.
- Connect the equipment to an outlet on a different circuit than the receiver.
- Consult the dealer or an experienced radio/TV technician for help.

WARNING

Any changes or modifications not expressly approved by the manufacturer could void the user's authority to operate the equipment.

GROUNDING INSTRUCTIONS

GROUNDING INSTRUCTIONS

- This product should be grounded. In the event of an electrical short circuit, grounding reduces the risk of electric shock by providing an escape wire for the electric current. This product is equipped with a cord having a grounding wire with a grounding plug. The plug must be plugged into an outlet that is properly installed and grounded.

DANGER - Improper use of the grounding plug can result in a risk of electric shock.

If repair or replacement of the cord or plug is necessary, do not connect the grounding wire to either flat blade terminal. The wire with insulation having an outer surface that is green with or without yellow stripes is the grounding wire.

Check with a qualified electrician or serviceman if the grounding instructions are not completely understood, or if in doubt as to whether the product is properly grounded.

- This product is for use on a nominal 120 V circuit, and has a grounding plug that looks like the plug illustrated in Figure A. A temporary adapter, which looks like the adapter illustrated in Figure B and C, may be used to connect this plug to a 2-pole receptacle as shown in Figure B if a properly grounded outlet is not available. The temporary adapter should be used only until a properly grounded outlet (Figure A) can be installed by a qualified electrician. The green-colored rigid ear, lug, or the like, extending from the adapter must be connected to a permanent ground such as a properly grounded outlet box cover. Whenever the adapter is used, it must be held in place by the screw.
- If it is necessary to use an extension cord, use only a three-wire extension cord that has a three-blade grounding plug, and a three-slot receptacle that will accept the plug on the product. Replace or repair a damaged cord.

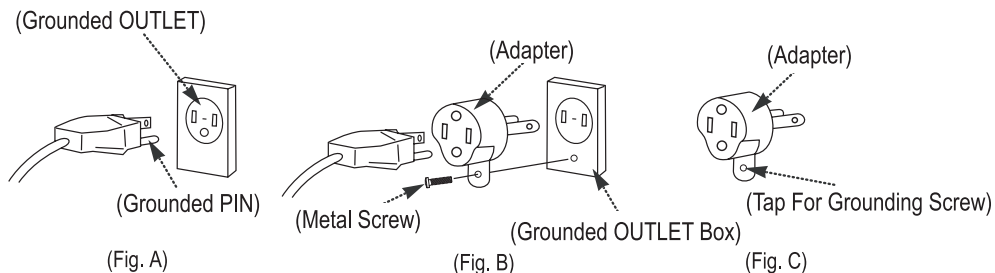

Parts Identification

SB-2400ER

Main unit

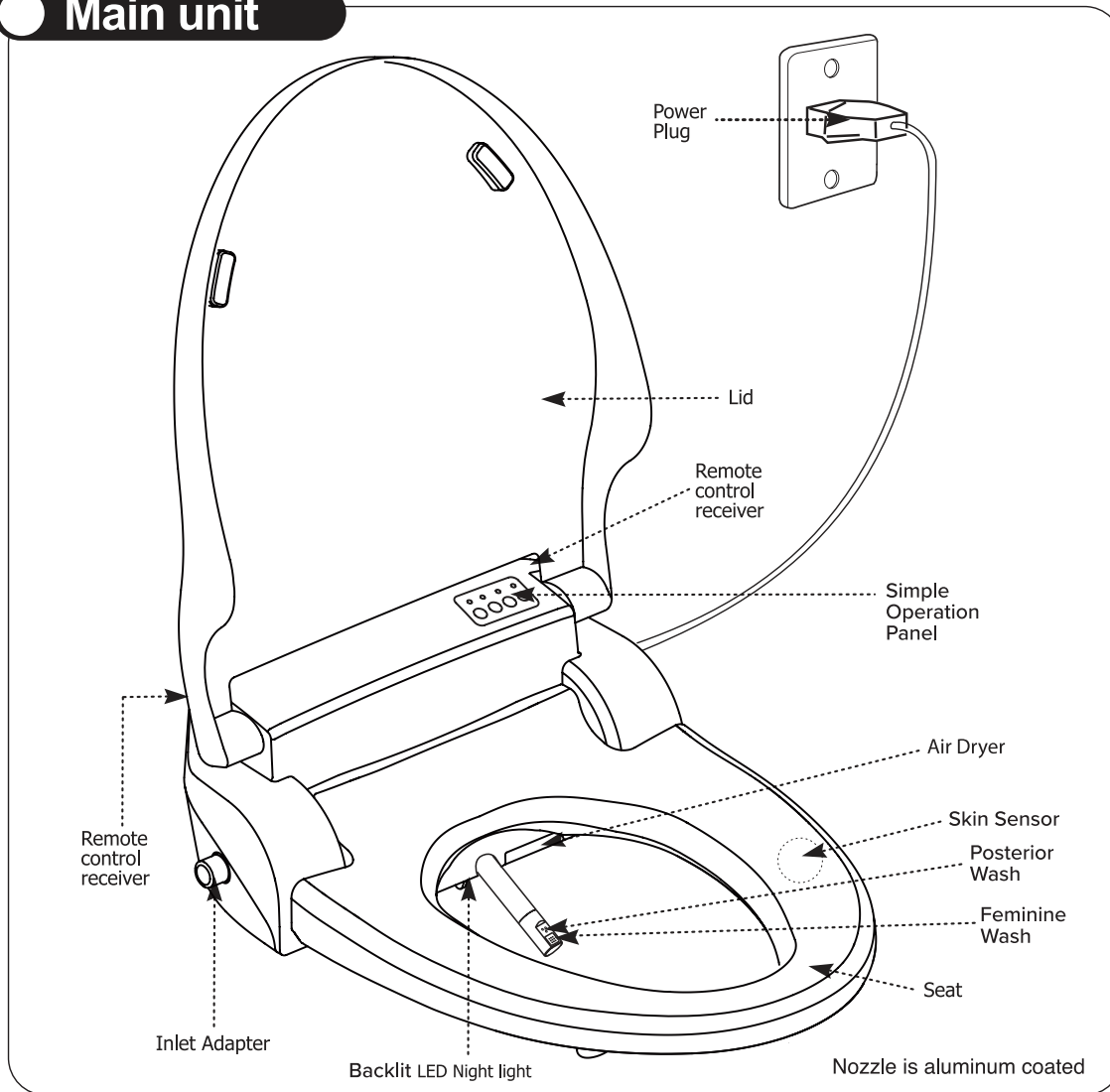

Remote Control

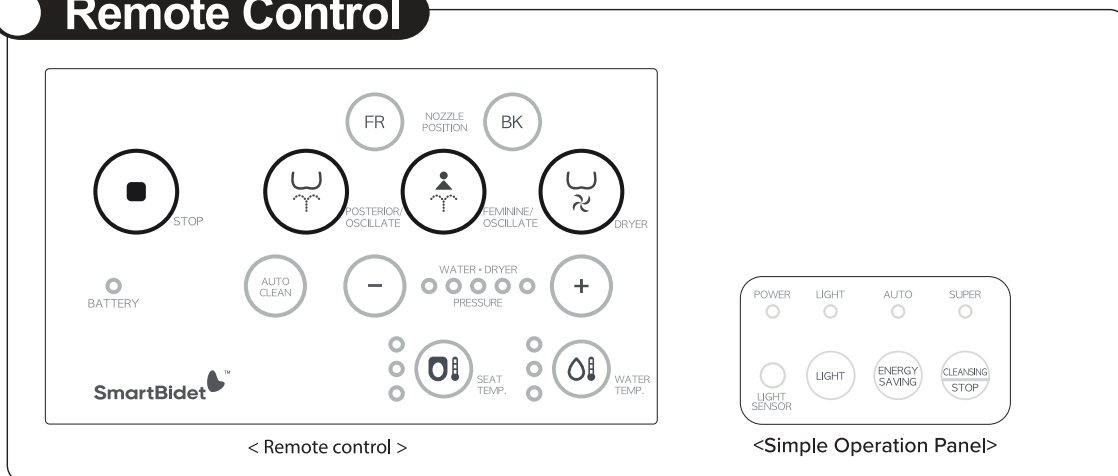

Parts Identification

Accessories

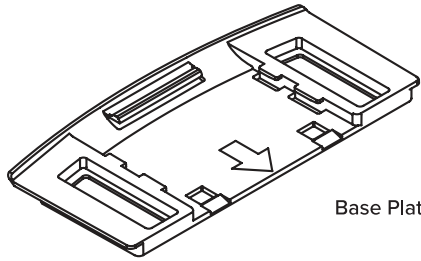

Base Plate

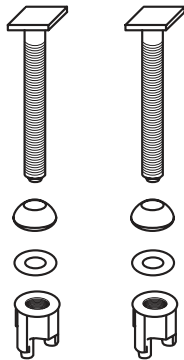

Mounting Bolts

Cone Packings

Washers

Nuts

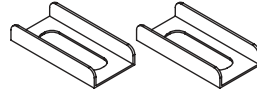

Bolt Cases

For the installation on toilets with top mounting bolts
(Refer to installation)

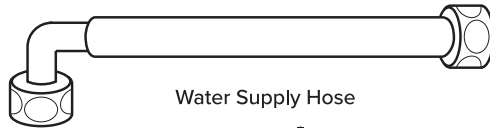

Water Supply Hose

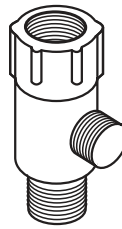

T-Valve

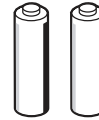

Batteries

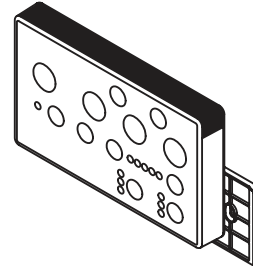

Remote Control
& Holder

Basic Instructions

- An auxiliary simple operation panel is on the body of the unit. However, due to its limited functionality, it cannot be used to adjust water pressure. When water pressure control is needed press any of the wash buttons on the remote control and adjust water pressure using the "+" or "-" button.
- Dropping or spilling liquids on the remote may cause damage.

1 Sit on the seat

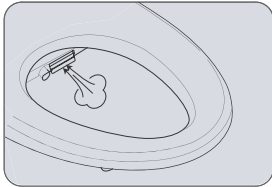

- If the seat is occupied, the unit will make a beep.

2 Press the " POSTERIOR " or " FEMININE " button

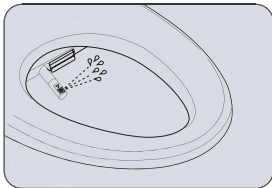

- Operate either the "Posterior" or the "Feminine" function .
- Each function operates for 1 minute.
- "Oscillate" function operates by pressing "Posterior" or "Feminine" button while using.
- Unit beeps when the "Posterior" or "Feminine" function is finished.

3 Press the " DRYER " button

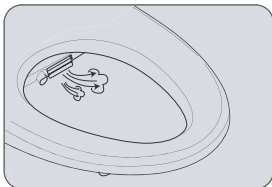

- Dryer function will operate for 3 minutes.
- Unit beeps when dryer function is finished.
- Drying operation may be maximized by gently removing any excess moisture with toilet paper.

4 Press the "STOP" button

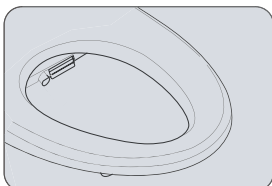

- Stops all operating functions.

- When using the unit, please center your weight on the bidet seat.
- The seat sensor is installed inside the seat. (Please refer to pages 5 or 6.) The unit starts operating only when the user's skin touches the seat sensor. **Seat covers or other materials on the seat may prevent the sensor from operating properly.**

Functions & Operation

Oscillate

- Start nozzle movement by pressing the "Posterior" or "Feminine" button while cleansing.
- Stop nozzle movement by pressing the "Posterior" or "Feminine" button again.

Water Pressure Adjustment

- The unit remembers the most recent water pressure settings.
- Water pressure can be adjusted by pressing the "+" or "-" button.

Nozzle Position Adjustment

- Press the "FR" or "BK" button to adjust the nozzle position during "Posterior" or "Feminine" function.
- It returns to the first middle position when finishing and moving away the seat.

Water Temperature Adjustment

- Press the "Water Temperature" button to adjust the water temperature level. Select the desired level.

Warm Seat Temperature Adjustment

- Press the "Seat Temperature" button to adjust the seat temperature level. Select the desired level.

※ The unit remembers the water and seat temperature settings even if the power is shut off.
No need to readjust the temperature settings after a power failure.

Functions & Operation

Warm Air Dryer Temperature Adjustment

- The unit remembers the most recent warm air temperature setting. Press "+" or "-" button to adjust the temperature of the warm air. (Levels 1~5)

LED Nightlight

- To activate the LED Nightlight, press the "LIGHT" button. The Nightlight activates automatically when it is dark. To cancel the LED Nightlight function, press the "LIGHT" button again and Nightlight will go off.
- When LED Nightlight function is on, the bidet can be used without turning on the toilet light.
- LED lights are very efficient and require a small amount of energy to operate.

Auto Energy Saving

- To activate, press the "ENERGY SAVING" button until the "AUTO" indicator is illuminated.
- When set to "AUTO" mode, both the water temperature (86°F) and seat temperature are maintained.
- When bidet is in use, the Auto Energy Saving function stops temporarily to allow custom adjustments. The Auto Energy Saving function reactivates when the seat is unoccupied.
- To cancel the Auto Energy Saving function, press the "ENERGY SAVING" button and the "AUTO" indicator will go off.

Super Energy Saving

- To activate, press the "ENERGY SAVING" button until the "SUPER" indicator is illuminated.
- Select this mode for optimal energy efficiency, using the unit's built-in sensors.
- When set to "ENERGY SAVING" mode both the water and seat temperature remain at room temperature. This power saving mode stops temporarily when the toilet light is on.
- To cancel the Super Energy Saving function, press the "ENERGY SAVING" button. The "SUPER" indicator will go off.

Functions & Operation

Auto Cleansing

- To activate the automatic (auto) cleansing function, press the "AUTO CLEAN" button. The "OSCILLATE" wash function and warm air dryer will operate for 1 minute each after activation.
- Default settings for this function are: "Level 3" for Water Pressure, "Level 2" for Warm Air Drying Temperature and "Level 3" for the Nozzle Position. These settings may be adjusted to suit user preference.
- When activated, the auto cleansing function will revert settings for both water and seat temperature to "Medium" by default. Settings may be adjusted to suit user preference.
- A buzzer will sound when the auto cleansing function is finished.
- Auto cleansing will return to default settings when the "AUTO CLEAN" or "STOP" buttons are pressed.
- This function is useful for individuals with impairments that make it difficult to select custom settings. It is also convenient for use with children.

Power On/Off

- To turn the unit off, press the "STOP" button for at least 4 seconds, until the power indicator light goes off.
- To turn the unit on, press any button except "FR", "BK", "HI", "LO" button on the remote control. The power indicator will light up.
- When the power is off, the unit remembers all of the prior settings, so it is not necessary to reset functions each time you turn the unit on.

Cleaning the Nozzle

- To clean the nozzle, press the "CLEANSING/STOP" and "ENERGY SAVING" buttons simultaneously on the Simple Panel. The nozzle extends and stops for easy cleaning.
- Clean the nozzle manually with a soft brush. To return nozzle to its storage position, press the "CLEANSING/STOP" button. The nozzle will retract and the self-cleaning function will begin.

Functions & Operation

Burn Protection System

- When the seat temperature is set to "HI," it will be reduced automatically when the unit is in use for more than 30 minutes. This protects the user from burns, which can occur when sitting on the unit for a long time.
- Seat temperature can be returned to "HI" by manually resetting temperature or moving away from the seat.

Self-Cleaning Nozzle

- Before and after each operation, the self-cleaning nozzle function will cleanse the nozzle head.

Changing batteries of remote control

- When the "BATTERY SIGN" indicator blinks on and off, remote buttons will not work properly and it is time to replace the batteries. However, the batteries may discharge quickly under certain operating conditions, such that the remote control unit may be disabled before the user notices the "BATTERY SIGN" indicator is blinking.

1. Remove remote control from the remote control holder.
2. Open the battery cover and replace batteries with new ones. (Battery life is about 1 year.)
3. Close the battery cover and insert remote control back into the remote control holder.

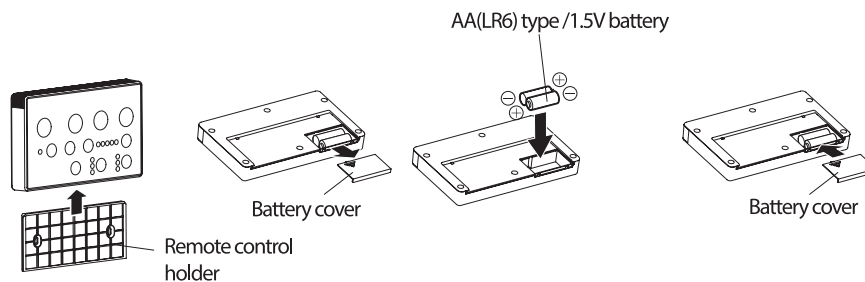

⚠ Caution

- Use only AA(LR6) / 1.5V batteries. There is a risk of explosion if battery is replaced with the wrong type. Dispose of used batteries properly according to battery manufacturers instructions.
- Insert the batteries according to the (+) , (-) indications marked on the remote control.
- Do not use used battery and new batteries together.

Installing Unit

Caution before installation!

- Make sure the size and shape of the bidet seat are compatible with the toilet.
- Check that all parts are included and ready for installation. Please check if other parts are needed for your installation.
- Do not connect the power until installation is complete.

1 Remove the existing toilet seat.

- Remove the existing toilet seat and lid by removing the fastening nuts from below.
- Keep the detached seat, lid, and nuts for later use.

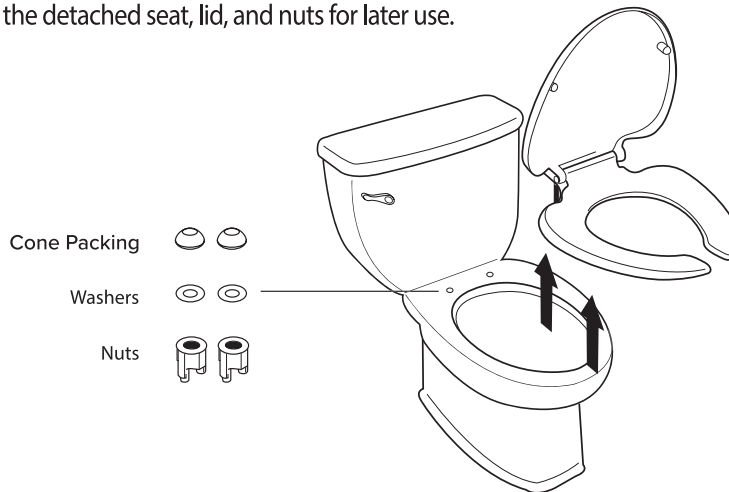

2 Shut off the water supply by turning the shut-off valve clockwise. Then completely drain the toilet water tank.

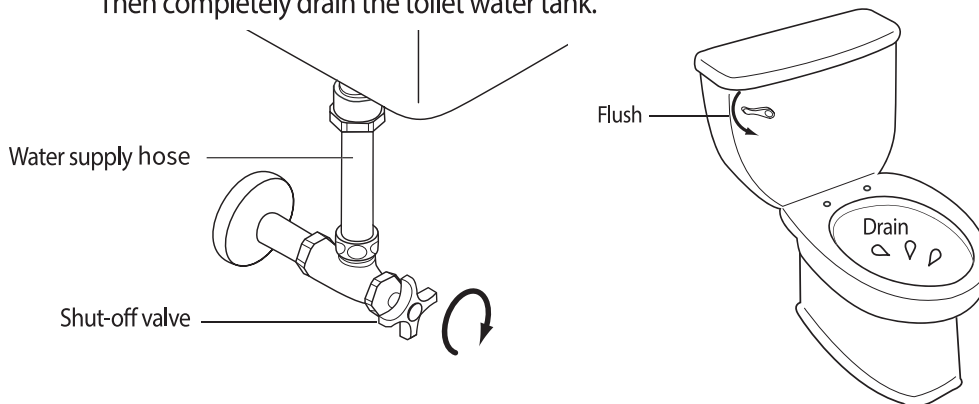

Installing Unit

- 3** Disconnect the water supply line from the toilet water tank and install a T-valve.

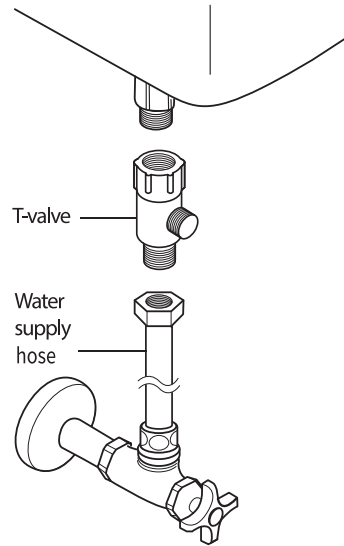

- 4** Line up the bolt slots in the Base plate with the bolt holes in the toilet bowl.

- 5.5" hole spacing is required for installation.

- 5** Insert mounting bolts through the bolt slots and into the bolt holes in the toilet.

- 6** Securely fasten the base plate by installing the cone packings and washers as shown below, and tightening the mounting bolts and nuts.

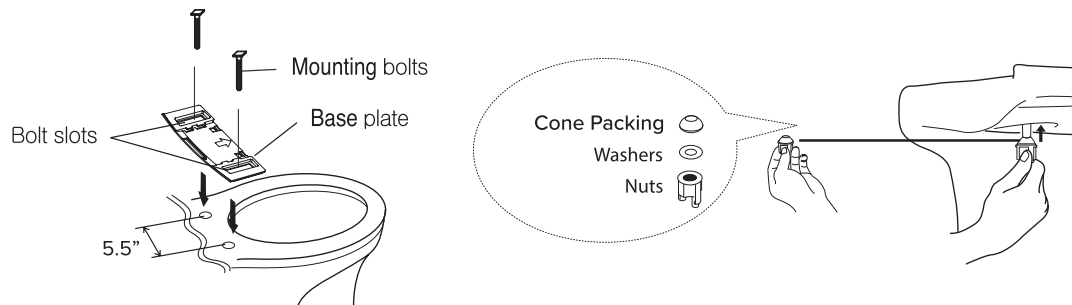

Installing Unit

< Toilets with Bolts Tightened from Above >

Reuse the mounting bolts from the existing toilet seat with the bolt cases included with the bidet.

- 4 Place the base plate so that the slots align with the bolt holes in the toilet.
- 5 Place the bolt cases on the base plate.
- 6 Fasten the base plate using the bolts removed from the existing toilet seat.

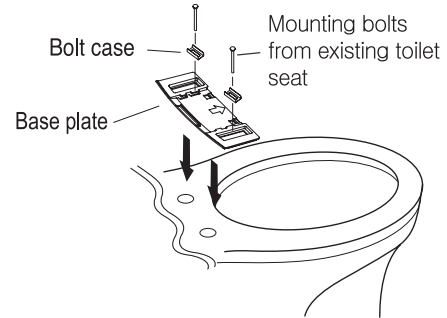

- 7 Connect the water supply hose to the bidet.

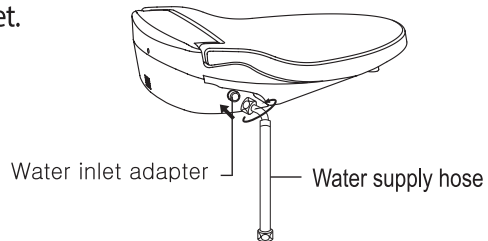

- 8 Slide the bidet unit onto the base plate by aligning the grooves under the bidet unit.

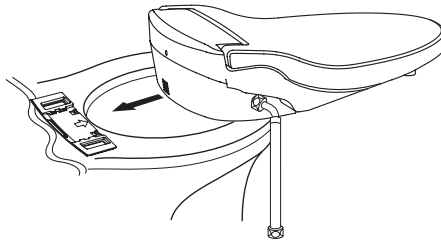

- 9 Connect the water supply hose to the T-valve

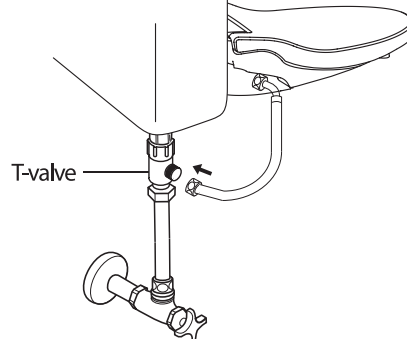

Installing Unit

- 10** Attach the remote control mounting plate to the wall with double-sided adhesive tape.

Double-sided tape

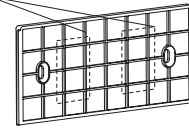

- 11** Insert batteries into the remote control unit, as shown below, and mount the unit to the mounting plate.

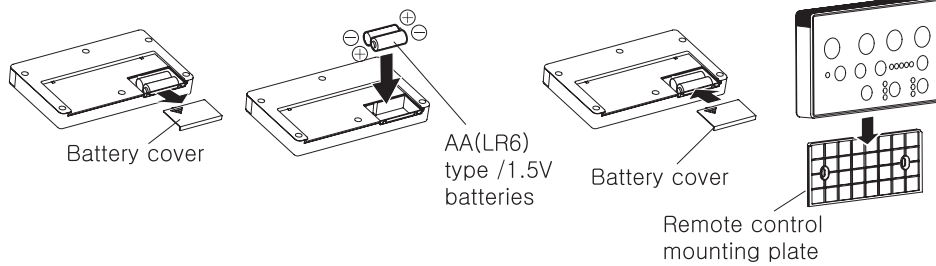

Trial Operation

- 1 Open the shut-off valve by turning counterclockwise.
- 2 Check for any water leakage from hose connections.

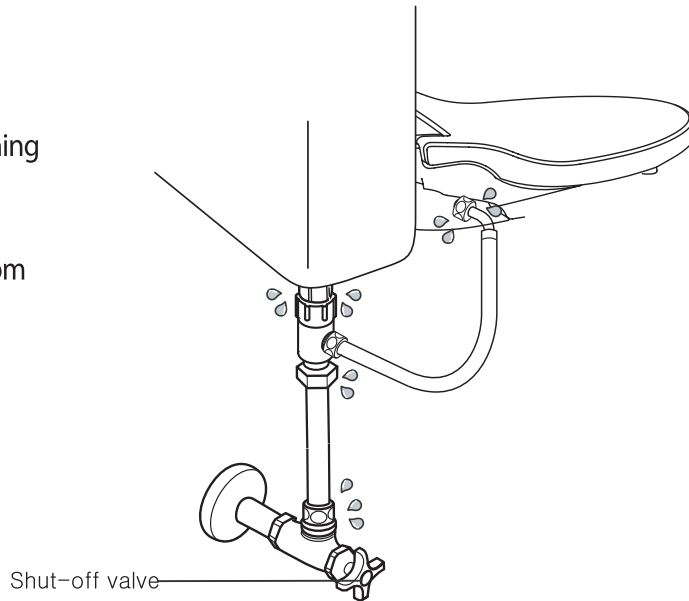

- 3 Plug in the power cord.
 - If the power indicator light does not illuminate after plugging in the power cord, press any button except "FR", "BK", "HI", or "LO" buttons to illuminate the indicator.

WARNING

Do not invert or otherwise move the bidet unit after it is connected to power. Doing so may cause damage to the bidet unit.

- 4 To fill the bidet's water tank, press the "Posterior" or "Feminine" button on the bidet unit. One long beep is emitted when the tank is full.

- 5 To test the water spray function, press either the "Posterior" or "Feminine" button while placing a hand on the seat sensor.

*Cover the nozzle with your hand or bucket to prevent spraying water out of the bowl.

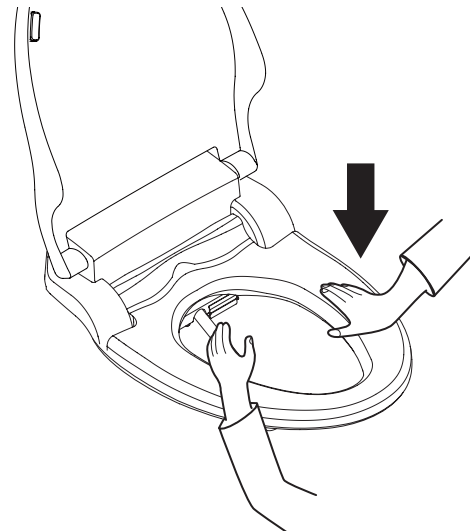

Uninstalling Unit

To detach or move the unit, follow the instructions shown below.

- 1 Unplug the power cord.
- 2 Shut off the water supply by turning the shut-off valve clockwise. Then completely drain the toilet water tank.
- 3 Disconnect the flexible hose from the T-valve, detach the bidet unit from the base plate, and unfasten the base plate from the toilet.

To detach the unit, pull it forward while lifting the front end, as shown.

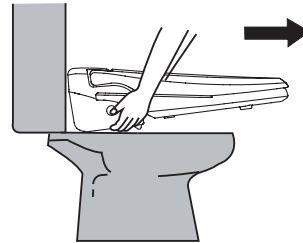

- 4 Completely drain the bidet's water tank by removing the drain plug from the bottom.

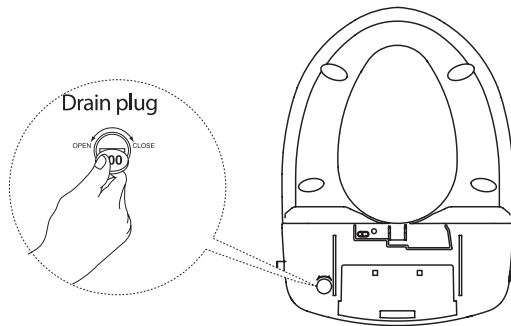

- 5 Disconnect the T-valve.
- 6 Reconnect the water supply hose to the toilet water tank.
- 7 Open the shut-off valve by turning it clockwise and then check for any leakage from connections.
- 8 Reinstall the original seat and lid onto the toilet.

< For service request >

Please contact the dealer where you purchased this unit or the supplier on the back of this manual.

Maintenance

Cleaning the Water Strainer

- 1** Shut off the water supply by turning the shut-off valve clockwise. Then completely drain the toilet water tank.
- 2** Disconnect the water supply hose from the water inlet adapter. If the hose is difficult to disconnect, such as from non-standard toilet bowls, detach the main bidet unit from the toilet before disconnecting the hose from the adapter.
- 3** First remove, clean, and reinstall the strainer from the water inlet adapter. (If it is hard to detach the strainer by hand, try using a wrench.)
- 4** Attach the hose to the water inlet adapter and open the water supply valve by turning it counter-clockwise.

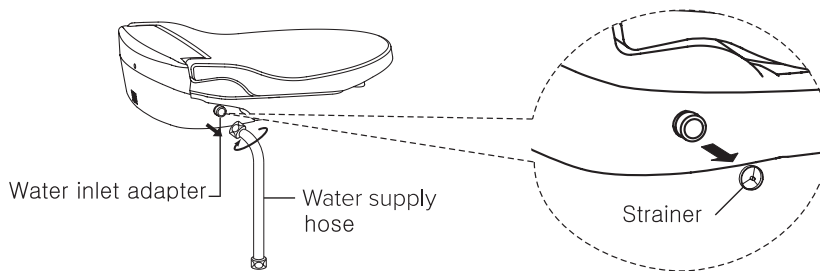

Cleaning the Nozzle

- 1** Press the "CLEANSING/STOP" and "ENERGY SAVING" buttons on the unit's Simple Panel simultaneously to extend and stop the nozzle in the extended position.
- 2** Clean the nozzle manually with a soft brush. To return the nozzle to its retracted position, press the "CLEANSING/STOP" button on the unit's Simple Panel, which automatically activates the self-cleaning function.

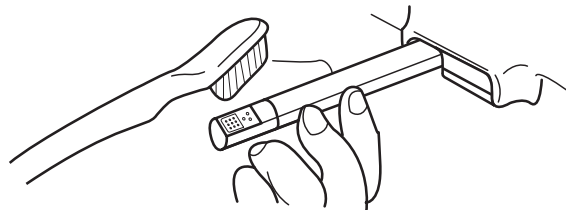

Maintenance

External Cleaning

- Do not use any harsh or strong household chemicals. Using abrasive materials, chemicals, and so on could damage the plastic exterior. We recommend using baking soda mixed with vinegar to clean the bidet.
- When using strong household chemicals to clean your toilet, make sure that the bidet seat does not come into contact with the toilet until it is fully dry.
- Do not spray water onto the unit. Wipe it with a tightly wrung damp soft cloth.
- Disconnect the unit from power before cleaning and be careful not to splash any water on the plug or socket.
- Touching the power supply socket with wet hands could cause an electric shock.

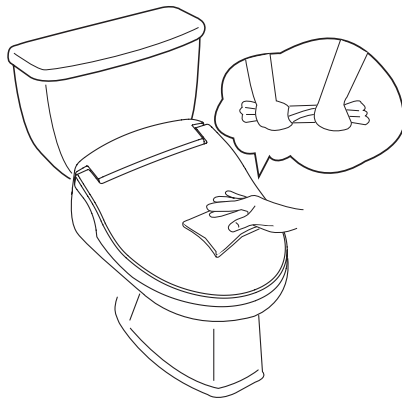

Draining the Bidet's Water Tank (Reservoir)

- 1 First, disconnect the power cord.
- 2 Close the shut-off valve by turning it clockwise.

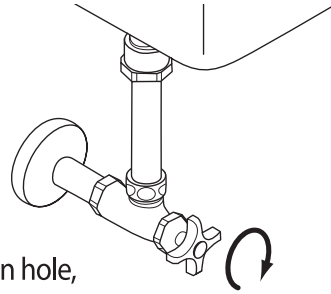

- 3 After placing a container (4-liter capacity) under the drain hole, remove the drain plug and completely drain the bidet's water tank.

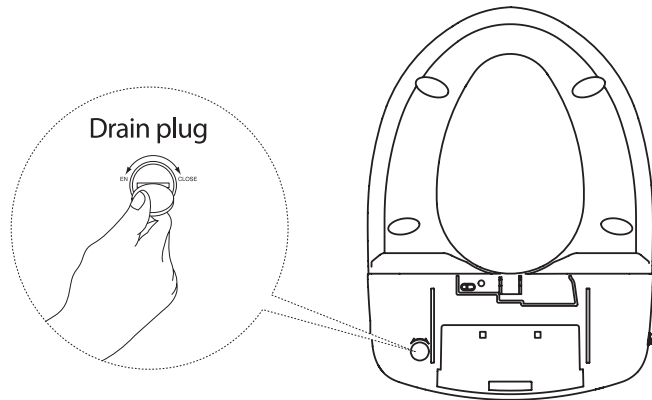

Prevent Freezing During Cold Temperatures

- 1 Plug in the power cord and confirm that bidet power is ON.
- 2 Adjust the water temperature level to "LO" or higher. Do not switch off the water temperature level.
- 3 Before extended periods of disuse, drain the bidet's water tank.

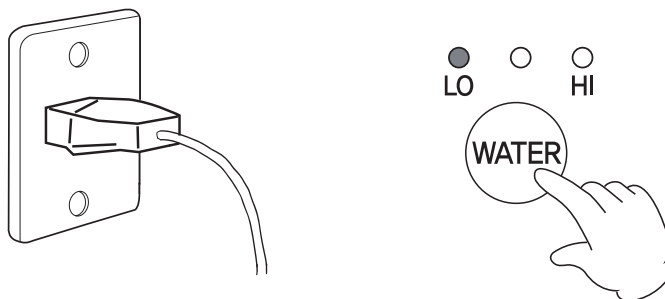

Troubleshooting

Check the following items before calling for service.

Problem Description	Possible Causes
Unit does not function at all	<ul style="list-style-type: none"> • The power is OFF. Check to see if GFCI has tripped. ☞ Check by pressing any button except "HI", "LO", "FR", "BK" buttons on the remote control. • Check if you're activating the skin sensor. • The power cord is disconnected. • There is a power failure or interruption.
Posterior, Feminine Dryer, Autoclean do not operate	<ul style="list-style-type: none"> • A seat cover or other object is covering the seat. ☞ Check whether there is anything on the seat. The unit only starts operating after the seat sensor detects skin contact.
Remote control does not function at all	<ul style="list-style-type: none"> • Batteries in the remote control have been exhausted • The three-phase power is used for toilet lighting. ☞ The remote control may not function if the toilet lighting uses three-phase lamps. If the remote control does not function properly after repositioning the remote control unit, try changing the toilet lighting to use standard lamps.
No water spray	<ul style="list-style-type: none"> • The shut-off valve is closed. • There is a water supply interruption.
Low water pressure	<ul style="list-style-type: none"> • The water pressure level is set to "LO". • The water strainer is clogged.
Water temperature is low	<ul style="list-style-type: none"> • The water temperature level is switched off or set to "LO".
Seat is not warm	<ul style="list-style-type: none"> • The warm seat temperature level is switched off or set to "LO".
Dryer is not warm	<ul style="list-style-type: none"> • The warm air dryer temperature level is switched off or set to "LO".

Product Specifications

Item		SB-2400ER	
Power Supply		120V~, 60Hz	
Max. Power Consumption		660W	
Length of Power Cord		3.94ft (1.2m)	
Water Supply Connection		Direct connection to the water supply	
Water Supply Pressure		14.223psi~106.675psi (98 - 735kPa)	
Cleansing	Water Flow Rate	Cleansing	Max. 0.251gal/min (0.95 ℓ /min)
		Bidet	Max. 0.251gal/min (0.95 ℓ /min)
	Water Pressure Adjustment	5 Levels	
	Temp. Adjustment	Normal Temp., 93.2°F(34°C), 98.6°F(37°C), 104°F(40°C)	
	Heater Capacity	600W	
	Safety Device	Thermal Fuse, Thermostat, Water Level Sensor	
Warm Seat	Temp. Adjustment	Normal Temp., 95°F(35°C), 100.4°F(38°C), 104°F(40°C)	
	Heater Capacity	55W	
	Safety Device	Thermostat	
Dry	Temp. Adjustment	Normal Temp. ~ 122°F(50°C) (5 Levels)	
	Heater Capacity	195W	
	Safety Device	Thermal Fuse, Bi-metal	
Water Supply Temp.		37.4°F(3°C) ~ 95°F(35°C)	
Temp. of circumstance for use		37.4°F(3°C) ~ 104°F(40°C)	
Product size	Elongated	1.26ft(W) x 1.74ft(L) x 0.51ft(H) (385mm x 530mm x 155mm)	
Product weight		9.04lbs(4.1kg)	

Warranty

General Limited Warranty Covered **Hitrons Solutions Inc** will warrant to the original retail buyer only, which falls in normal use and within the applicable periods specified below.

Hitrons Solutions Inc replacements will be warranted to the original purchaser of the products only.

The Parts Warranty If the parts fail within Twelve(12)months after original purchase from authorized retailer, following the installation manual and normal operation, **Hitrons Solutions Inc** will furnish replacement part(s) after warranty registration.

● This Warranty does not cover the following

1. Defects and/or malfunctions from failure to properly install, operate and/or maintain the unit in accordance with the installation manual.
2. Damage from abuse, fire, flood, freeze, and any other acts of Nature.
3. Damage resulting from unauthorized alterations, attachments and/or repairs.
4. If the product was not installed properly.
5. Damage to the unit by animals, mice or insects.
6. Damage caused by excess moisture or from water clogging the bathroom or restroom.
7. Damage from not being installed in accordance with all applicable local codes, ordinances and good trade practices.
8. Color fading due to use in wrong environment.
9. Damage from chemicals.
10. The warranty will not be covered without providing the date of purchase with original receipt.

Customer Service Center

SmartBidet 

HITRONS
SOLUTIONS INC

 ADDRESS
88 Portland Avenue Suite M
Bergenfield, NJ 07621

 TOLL-FREE NUMBER
1-800-515-3430
Monday to Friday
9:00am to 5:00pm EST

 EMAIL
cs@smartbidet.net
www.smartbidet.net